

English

Edition 1

This publication could contain technical inaccuracies or typographical errors. Changes are made periodically to the information herein; these changes will be made in later editions. IBM may make improvements and/or changes in the product(s) and/or program(s) at any time.

It is possible that this publication may contain reference to, or information about, IBM products (machines and programs), programming, or services that are not announced in your country.

Requests for copies of this publication and for technical information about IBM products should be made to your IBM Authorized Dealer or IBM Retailer.

No part of this publication may be reproduced or distributed in any form or by any means without prior permission in writing from the International Business Machines Corporation.

References in this publication to IBM products, programs, or services do not imply that IBM intends to make these available in all countries in which IBM operates. Any reference to an IBM product, program or service is not intended to state or imply that only IBM's product, program, or service may be used. Any functionally equivalent product, program, or service that does not infringe any of IBM's intellectual property rights or other legally protectable rights may be used instead of the IBM product, program, or service. Evaluation and verification

of operation in conjunction with other products, programs, or services, except those expressly designated by IBM, are the user's responsibility.

IBM may have patents or pending patent applications covering subject matter in this document. The furnishing of this document does not give you any license to these patents.

Trademarks

The following terms, used in this publication, are trademarks or service marks of the IBM Corporation in the United States or other countries:

IBM HelpCenter
ENERGY STAR is a **U.S.** registered mark.

© Copyright International Business Machines Corporation 1998.
All rights reserved.

Contents

Contents.....	1
Setup	2
User controls	5
On-Screen-Display	7
Further information	14
Specifications	16
Troubleshooting	18
Compliances	A1
Warranty	A4

Setup

Important: Before connecting the monitor, turn off the computer and attached devices. Also ensure the power at the electrical outlet matches the power requirements of the monitor. Refer to the **Specifications** section on page 16 /17 for more details.

Attaching the Stand

1. Place the monitor face down on a soft surface to prevent the screen being scratched.
2. Insert the hooks (1) into the matching slots on the underside of the monitor (2).
3. Slide the base towards the front of the monitor until the latch (3) clicks into the locked position.

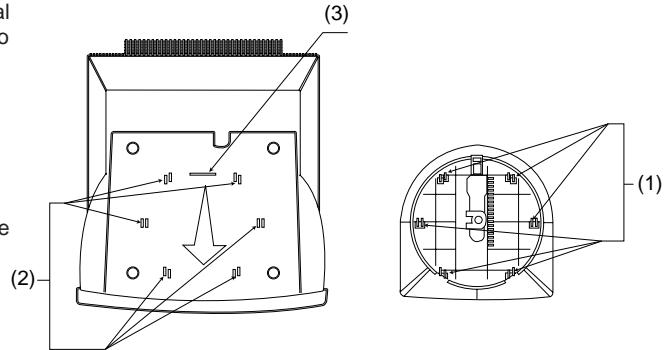

Connecting your monitor

1. Connect the signal cable to the video port on the back of your computer (figure A). Your computer may have a video adapter card installed. In this case, attach the signal cable to the connector on the video adapter card (figure B).
2. Connect the power cord to the monitor first, then firmly insert the plug into a properly grounded electrical outlet.
3. Turn on the monitor, and then the computer.

If your monitor does not seem to be working correctly, refer to the **Troubleshooting** section on page 18 for help.

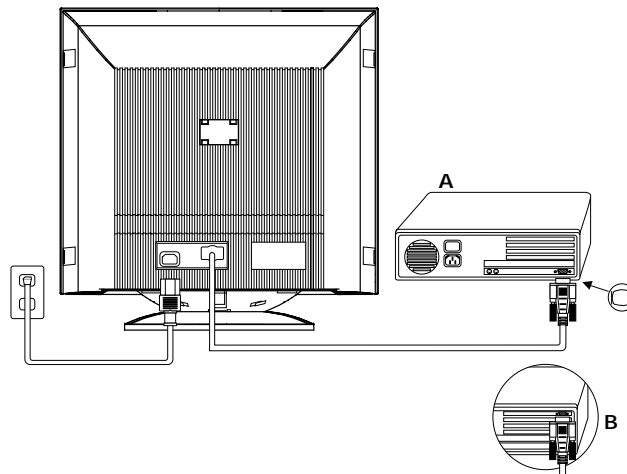

Workplace preparation

Positioning the Monitor

Choose a suitable place to position the monitor where it is not near fluorescent desk lighting or any equipment that produces magnetic fields that could cause interference. Ensure that the furniture or equipment can support the weight of the monitor. Allow at least 2 inches (50mm) ventilation space around the monitor.

Height

The monitor should be positioned so that the top of the screen is slightly below your eye level when you sit at your workstation.

Orientation

Choose a position that gives the least reflection from lights and windows, usually at a right angle to any windows. The monitor should be positioned directly in front of you so that you do not have to twist your body. Tilt the monitor to a comfortable viewing angle.

Working Practices

Rest

Take regular breaks. Vary your posture, and stand up and stretch occasionally as prolonged use of computer workstations can be tiring.

Back

You should sit back in the chair and use the back rest.

Hands

Use a light touch on the keyboard, keeping your hands and fingers relaxed. Allow a space in front of the keyboard to rest your wrists when not typing. Consider using a wristpad.

Eyesight

Working with monitors, in common with any prolonged close work, can be visually demanding. Look away from the screen periodically and have your eyesight checked regularly.





Screen settings

Set the screen brightness and contrast to a comfortable level. You may have to adjust this as the lighting changes during the day. Many application programs let you select colour combinations which can help you to view in comfort.

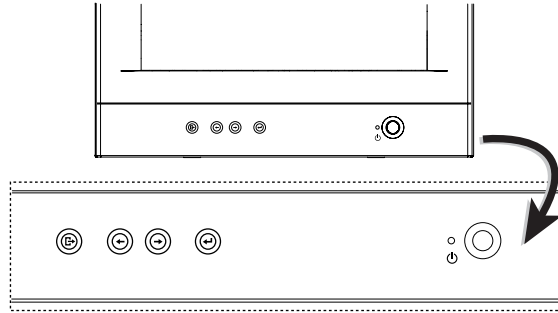
User controls

The image is already optimised for many display modes. However, the controls can be used to adjust the image to your liking.



Icon	Control	Description
	Power switch.	Switches the monitor on and off.
	OSD/Select	Activates the On-Screen-Display / select control icon.
	Move right /down; Contrast adjustment selection	This control has two functions : 1) To move the highlighted icons to the right for selection. Also used to adjust image after control icon has been selected. 2) To adjust the image contrast .
	Move left /up; Brightness adjustment selection	This control has two functions : 1) To move the highlighted icons to the left for selection. Also used to adjust image after control icon has been selected. 2) To adjust the image brightness.
	Exit	Exit OSD control. Note: by selecting this button, the current set up will be saved

Contrast and Brightness

Contrast and Brightness can be adjusted as follows, without the need to display the OSD. Select function and use " ← " " → " control to adjust: If adjustment is not made within 15 seconds, the current setup will be saved and the control screen will disappear automatically.



Icon	Control	Description
→	Contrast	Adjusts contrast between foreground and background
←	Brightness	Adjusts background brightness

On-Screen-Display

Activating the On-Screen-Display

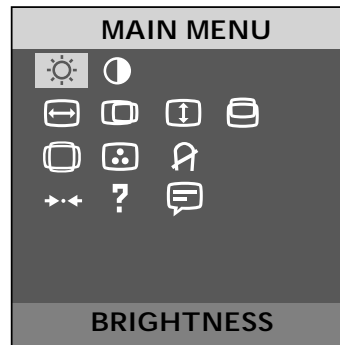
The monitor controls are accessed by pressing button  to enable OSD (On-Screen-Display). The main menu will be displayed as follows.





















Each Sub-Menu icon is selected by highlighting it via the "←" "→" control and pressing button (). To exit the main or Sub-Menu, press the exit button ().

Note: (1) To unlock / lock the adjustments made using the OSD, press and hold() for 10 seconds.

(2) If no adjustment or selection of any OSD menu is made within 15 seconds, the current setup will be saved and the OSD will disappear automatically.

















Brightness & Contrast



Function	Effect of Control		Description
	←	→	
 BRIGHTNESS			Adjusts background brightness
 CONTRAST			Adjusts contrast between foreground and background



Screen Size & Position			
Function	Effect of Control		Description
	←	→	
 WIDTH			Adjusts image width
 H-POSITION			Moves image left or right
 HEIGHT			Adjusts image height
 V- POSITION			Moves image up or down









Advanced

Function	Effect of Control		Description
	←	→	
 PINCUSHION			Adjusts the amount of curvature on the vertical edges in opposite directions.
 TRAPEZOID			Equalizes the length of the top and bottom edges.
 PARALLELOGRAM			Adjusts the tilt of the vertical edges.
 PINCUSHION BALANCE			Adjusts the amount of curvature on the vertical edges in the same direction.
 ROTATION			Tilts the image clockwise or counter-clockwise.
 MOIRE			Moire cancellation function.

 Color	
Function	Description
9300 K	Factory preset color temperature of 9300 K
6500 K	Factory preset color temperature of 6500 K
 R G B	User set 1 for color temperature. Select R, G or B for adjustment using the user controls. Adjusts red intensity. Adjusts green intensity. Adjusts blue intensity.
 R G B	User set 2 for color temperature. Select R, G or B for adjustment using the user controls. Adjusts red intensity. Adjusts green intensity. Adjusts blue intensity.

Degauss & Reset	
Function	Description
 DEGAUSS	<p>Demagnetizes the monitor . Discoloration of the image can be caused by gradual magnetization of the monitor components. This is particularly likely to occur when the monitor is moved or rotated. The monitor may "buzz" momentarily when this user control is selected and the image will change color and wobble for a few seconds. These effects are normal. Do not use this feature more than once in any 30 minutes period.</p> <p>YES :The screen will degauss. NO:Escape the DEGAUSS function.</p>
 RESET	<p>Reset all settings back to the factory defaults.</p> <p>YES:Confirm the RESETfunction. NO:Escape the RESET function.</p>

 Information	
Function	Description
 USER / PRESET MODE	The screen displays the details of the user defined display modes. Press "  " or "  " to switch between the Preset or User Mode screens. The details displayed are addressability, refresh rate, horizontal frequency, sync polarity and the current mode of operation.

 Language	
Function	Description
 LANGUAGE	Select the OSD language .The available languages are English (default), German, Spanish, French and Italian.

Further information

Display modes

The display mode the monitor uses is controlled by the computer. Therefore you should refer to your computer documentation for details on how to change display modes.

The image size, position and shape may change when the display mode changes. This is normal and the image can be readjusted using the monitor controls.

To ensure flicker-free operation, select the highest (non-interlaced) refresh rate both the computer and the monitor can support, (generally 75 Hz or higher), for the addressability that your application requires.

For the display modes listed below, the screen image has been optimised during manufacture.

Addressability	Refresh Rate	Horizontal Frequency
720 x 400	70 Hz	31.5 kHz
720 x 400	85 Hz	37.9 kHz
640 x 480	60 Hz	31.5 kHz
640 x 480	75 Hz	37.5 kHz
640 x 480	85 Hz	43.3 kHz
800 x 600	75 Hz	46.9 kHz
800 x 600 *	85 Hz	53.7 kHz
1024 x 768	75 Hz	60.0 kHz
1024 x 768 **	85 Hz	68.7 kHz
MFI 2	75 Hz	41.8 kHz

Table 1. Factory Preset Mode

* Recommended mode for G54

** Recommended mode for G74

Power Management

To benefit from power management, the monitor must be used in conjunction with a computer that implements the Video Electronics Standards Association (VESA) Display Power Management Signalling (DPMS) Standard.

The power management feature is invoked when the computer recognizes that you have not used your mouse or keyboard for a user-definable period of time. There are several states as described in the table below.

State	Power indicator	Screen	Restoring Operation	Compliance
On	Steady green	Normal		
VESA Standby	Steady Yellow	Blank	Press a key or move the mouse.*	
VESA Suspend	Steady Yellow	Blank	Press a key or move the mouse.*	ENERGY STAR
VESA Off	Steady Amber	Blank	Press a key or move the mouse.*	NUTEK

* There may be a slight delay before the picture returns

Specifications

The G54 (M/T 6546) color monitor uses a 15 inch FST CRT with a viewable image size of 13.7 inches (349 mm)

Dimensions	Width: Depth: Height:	14.6 inch (370 mm) 15.6 inch (396 mm) 15.7 inch (398 mm)
Weight		30 lb (13.6 Kg)
Tilt Swivel	Forward tilt: Backward tilt: Swivel:	4.8° 12.5° + 90° / -230°
Image	Maximum Height: Maximum Width: Dot Pitch:	8.3 inch (210 mm) 11.0 inch (280 mm) 0.28 mm
Power input	Supply Voltage: Max Supply Current:	100 -240 Vac 50-60 Hz 1.6 A at 100 Vac
Video input	Input Signal: Horiz. Addressability: Vert. Addressability: Clock Rate:	Analogue Direct Drive, 75 ohm 0-0.7v 1280 pels (max.) 1024 lines (max.) 110 Mpels/sec

Communications	VESA DDC	1 / 2 B
Synchronization Range	Horiz. Frequency: Vert. Frequency:	30 kHz - 69 kHz 50 Hz - 120 Hz
Power Consumption (Typical)	Normal Operation: VESA Standby: VESA Suspend: VESA Off:	< 100 W < 15 W < 15 W < 5 W
Environment	Operating Temperature: Storage Temperature: Shipping Temperature: Operating Humidity: Storage Humidity: Shipping Humidity: Emissions:	5 to 40° C -25 to 60° C -20 to 60° C 8 to 80% 20 to 80% 20 to 90% MPR-II

Specifications

The G74 (M/T 6547) color monitor uses a 17 inch FST CRT with a viewable image size of 15.9 inches (403 mm)

Dimensions	Width: Depth: Height:	16.2 inch (413 mm) 17.5 inch (445 mm) 17.7 inch (449 mm)
Weight		41.8 lb (19 Kg)
Tilt Swivel	Forward tilt: Backward tilt: Swivel:	4.8° 15° + 90° / - 230°
Image	Maximum Height: Maximum Width: Dot Pitch:	9.5 inch (242 mm) 12.7 inch (323 mm) 0.27 mm
Power input	Supply Voltage: Max Supply Current:	100 -240 Vac 50-60 Hz 1.8 A at 100 Vac
Video input	Input Signal: Horiz. Addressability: Vert. Addressability: Clock Rate:	Analogue Direct Drive, 75 ohm 0-0.7v 1280 pels (max.) 1024 lines (max.) 110 Mpels/sec

Communications	VESA DDC	1 / 2 B
Synchronization Range	Horiz. Frequency: Vert. Frequency:	30 kHz - 69 kHz 50 Hz - 120 Hz
Power Consumption (Typical)	Normal Operation: VESA Standby: VESA Suspend: VESA Off:	< 110 W < 15 W < 15 W < 5 W
Environment	Operating Temperature: Storage Temperature: Shipping Temperature: Operating Humidity: Storage Humidity: Shipping Humidity: Emissions:	5 to 40° C -25 to 60° C -20 to 60° C 8 to 80% 20 to 80% 20 to 90% MPR-II

Troubleshooting

If you have a problem setting up or using your monitor, you may be able to solve it yourself. Before calling your retailer or IBM you should try the suggested actions that are appropriate to your problem.

Problem	Possible Cause	Suggested Action	Reference
Screen is blank and power indicator is off.	No power to monitor.	<ul style="list-style-type: none">• Ensure the electrical outlet and the monitor are both switched on.• Check power cord is firmly plugged into the monitor and the electrical outlet.• If the power cord plug has a removable fuse, replace it.• Try another power cord.• Try another electrical outlet.	Setup section starting on page 2
Screen is blank and power indicator is steady green.	Brightness and Contrast may be too low.	<ul style="list-style-type: none">• Adjust brightness and contrast.	User controls section starting on page 5
"SIGNAL OUT OF RANGE" message is displayed .	Display mode of the computer is outside the range of the monitor.	<ul style="list-style-type: none">• Reconfigure the computer to use a supported display mode.	Further information section starting on page 14
"CHECK SIGNAL CABLE" message is displayed.	Video cable connection.	<ul style="list-style-type: none">• Check the signal cable is firmly connected to the computer.• Check no pins are bent in the signal cable connector.	

Problem	Possible Cause	Suggested Action	Reference
Screen is blank and power indicator is steady yellow or steady amber.	The monitor is in Power Management Standby / Suspend or Off state.	<ul style="list-style-type: none"> ● Press any key on the keyboard or move the mouse to restore operation. 	
	No video signal from the computer.	<ul style="list-style-type: none"> ● Check the computer is powered on. ● Check the signal cable is firmly connected to the computer. ● Check no pins are bent in the signal cable connector. 	
Image appears to be flickering.	The monitor is operating in an interlaced or low refresh rate display mode.	<ul style="list-style-type: none"> ● Reconfigure the computer to use a non-interlaced display mode with a refresh rate of at least 75 Hz. 	Further information section starting on page 14
	The monitor may be affected by interference from nearby equipment.	<ul style="list-style-type: none"> ● Move fluorescent desk lighting or any equipment that produces magnetic fields further away from the monitor. ● If another monitor is close by, a separation distance of at least 12 inches (300mm) is recommended. 	

Problem	Possible Cause	Suggested Action	Reference
Image appears to be discolored.	The monitor may be affected by interference from nearby equipment.	<ul style="list-style-type: none"> ● Move any equipment that produces magnetic fields (e.g. sub woofer loud speakers) further away from the monitor. ● If another monitor is close by, a separation distance of at least 12 inches (300mm) is recommended. 	
	Magnetization of monitor components has built up.	<ul style="list-style-type: none"> ● Degauss the monitor using OSD manual demagnetize function. This function can only be used once in a 30 minute period. 	

Further help

If you are unable to correct the problem yourself, you may seek further help as follows:

Call IBM HELPCENTER.

In the US call 1-800-772-2227

In Canada call 1-800-565-3344

In other countries, contact your dealer, retailer, or other IBM authorized servicer.

Before calling, please have available as much of the following information as possible:

1. Type, model and serial number from the label on the back of your monitor.
2. Purchase receipt.
3. Description of problem.
4. Computer type and model.
5. System configuration (hardware fitted etc.).
6. System BIOS version number.
7. Operating System and version number.
8. Display driver version number.

If possible, stay by your computer system. Your technical support representative might want to go through the problem with you during the call.

Compliances

Federal Communications Commission (FCC) Statement

This equipment has been tested and found to comply with the limits for a Class B digital device, pursuant to Part 15 of the FCC Rules. These limits are designed to provide reasonable protection against harmful interference in a residential installation. This equipment generates, uses, and can radiate radio frequency energy and, if not installed and used in accordance with the instructions, may cause harmful interference to radio communications.

However, there is no guarantee that interference will not occur in a particular installation. If this equipment does cause harmful interference to radio or television reception, which can be determined by turning the equipment off and on, the user is encouraged to try to correct the interference by one or more of the following measures:

- Reorientate or relocate the receiving antenna.
- Increase the separation between the equipment and receiver.
- Connect the equipment into an outlet on a circuit different from that to which the receiver is connected.
- Consult an IBM authorized dealer or service representative for help.

Properly shielded and grounded cables and connectors must be used in order to meet FCC emission limits. Proper cables and connectors are available from IBM authorized dealers. IBM is not responsible for any radio or television interference caused by using other than recommended cables and connectors or by unauthorized changes or modifications to this equipment. Unauthorized changes or modifications could void the user's authority to operate the equipment.

This device complies with Part 15 of the FCC Rules. Operation is subject to the following two conditions: (1) this device may not cause harmful interference, and (2) this device must accept any interference received, including interference that may cause undesired operation.

Industry Canada Compliance Statement

This Class B digital apparatus meets the requirements of the Canadian Interference-Causing Equipment Regulations.

Cet appareil numérique de la classe B respecte toutes les exigences du Règlement sur le matériel brouilleur du Canada.

Power Cords

For your safety, IBM provides a power cord with a grounded attachment plug to use with this IBM product. To avoid electrical shock, always use the power cord and plug with a properly grounded power outlet.

IBM power cords used in the United States and Canada are listed by the Underwriters Laboratories (UL) and certified by the Canadian Standards Association (CSA).

For units intended to be operated at 115 volts: Use a UL listed and CSA certified cord set consisting of a minimum 18 AWG, type SVT or SJT, three conductor cord, a maximum of 4.5 meters (15 feet) in length and a parallel blade, grounding type attachment plug rated 15 amperes, 125 volts.

For units intended to be operated at 230 volts (U.S. use): Use a UL listed and CSA certified cord set consisting of a minimum 18 AWG, type SVT or SJT, three conductor cord, a maximum of 4.5 meters (15 feet) in length and a tandem blade, grounding type attachment plug rated 15 amperes 250 volts.

For units intended to be operated at 230 volts (outside the U.S.): Use a cord set with a grounding type attachment plug rated 13 amperes (minimum), 250 volts. The cord set should be marked <HAR> and have the appropriate safety approvals for the country in which the equipment will be installed.

MPRII

This product complies with Swedish National Council for Metrology (MPR) standards issued in December 1990 (MPRII) for very low frequency (VLF) and extremely low frequency (ELF).



As an ENERGY STAR Partner, IBM Corporation has determined that this product meets the ENERGY STAR guidelines for Energy Efficiency.

NOM

IBM de México, S.A.
IBM G54 Monitor de Color (M/T 6546)
IBM G74 Monitor de Color (M/T 6547)

Planta de Manufactura
Gabino Durán No 7930 esq.
Ponciano Arriaga
Parque Ind. Los Azecas C.P. 32679
Cd. Juárez, Chih.

Hecho en México
NOM -018
Consumo de Corriente 1.8 A
Frecuencia de Operacion 50/60 Hz
Rension de Alimentacion 100 - 240 V

Warranty

Statement of Limited Warranty US Canada and Puerto Rico

The warranties provided by IBM in this Statement of Limited Warranty apply only to Machines you originally purchase for your use, and not for resale, from IBM or your reseller. The term "Machine" means an IBM machine, its features, conversions, upgrades, elements, or accessories, or any combination of them. Unless IBM specifies otherwise, the following warranties apply only in the country where you acquire the Machine. If you have any questions, contact IBM or your reseller.

Machine: G54 (M/T 6546), G74 (M/T 6547)

Warranty Period*: Three years

* Contact your place of purchase for warranty service information.

Production Status

Each Machine is manufactured from new parts, or new and used parts. In some cases, the Machine may not be new and may have been previously installed. Regardless of the Machine's production status, IBM's warranty terms apply.

The IBM Warranty for Machines

IBM warrants that each Machine 1) is free from defects in materials and workmanship and 2) conforms to IBM's Official Published Specifications. The warranty period for a Machine is a specified, fixed period commencing on its Date of Installation. The date on your receipt is the Date of Installation, unless IBM or your reseller informs you otherwise.

During the warranty period IBM or your reseller, if authorized by IBM, will provide warranty service under the type of service designated for the Machine and will manage and install engineering changes that apply to the Machine. For IBM or your reseller to provide warranty service for a feature, conversion, or upgrade, IBM or your reseller may require that the Machine on which it is installed be 1) for certain Machines, the designated, serial-numbered Machine

and 2) at an engineering-change level compatible with the feature, conversion, or upgrade. Many of these transactions involve the removal of parts and their return to IBM. You represent that all removed parts are genuine and unaltered. A part that replaces a removed part will assume the warranty service status of the replaced part.

If a Machine does not function as warranted during the warranty period, IBM or your reseller will repair it or replace it with one that is at least functionally equivalent, without charge. The replacement may not be new, but will be in good working order. If IBM or your reseller is unable to repair or replace the Machine, you may return it to your place of purchase and your money will be refunded.

If you transfer a Machine to another user, warranty service is available to that user for the remainder of the warranty period. You should give your proof of purchase and this Statement to that user. However, for Machines which have a life-time warranty, this warranty is not transferable.

Warranty Service

To obtain warranty service for the Machine, you should contact your reseller or call IBM. In the United States, call IBM at 1-800-772-2227. In Canada, call IBM at 1-800-565-3344. You may be required to present proof of purchase. IBM or your reseller will provide certain types of repair and exchange service, either at your location or at IBM's or your reseller's service center, to restore a Machine to good working order.

When a type of service involves the exchange of a Machine or part, the item IBM or your reseller replaces becomes its property and the replacement becomes yours. You represent that all removed items are genuine and unaltered. The replacement may not be new, but will be in good working order and at least functionally equivalent to the item replaced. The replacement assumes the warranty service status of the replaced item. Before IBM or your reseller exchanges a Machine or part, you agree to remove all features, parts, options, alterations, and attachments not under warranty service. You also agree to ensure that the Machine is free of any legal obligations or restrictions that prevent its exchange.

You agree to:

1. obtain authorization from the owner to have IBM or your reseller service a Machine that you do not own; and
2. where applicable, before service is provided -
 - a. follow the problem determination, problem analysis, and service request procedures that IBM or your reseller provide,
 - b. secure all programs, data, and funds contained in a Machine, and
 - c. inform IBM or your reseller of changes in a Machine's location.

IBM is responsible for loss of, or damage to, your Machine while it is 1) in IBM's possession or 2) in transit in those cases where IBM is responsible for the transportation charges.

Extent of Warranty

IBM does not warrant uninterrupted or error-free operation of a Machine. The warranties may be voided by misuse, accident, modification, unsuitable physical or operating environment, improper maintenance by you, removal or alteration of Machine or parts identification labels, or failure caused by a product for which IBM is not responsible.

THESE WARRANTIES REPLACE ALL OTHER WARRANTIES OR CONDITIONS, EXPRESS OR IMPLIED, INCLUDING, BUT NOT LIMITED TO, THE IMPLIED WARRANTIES OR CONDITIONS OF MERCHANTABILITY AND FITNESS FOR A PARTICULAR PURPOSE. THESE WARRANTIES GIVE YOU SPECIFIC LEGAL RIGHTS AND YOU MAY ALSO HAVE OTHER RIGHTS WHICH VARY FROM JURISDICTION TO JURISDICTION. SOME JURISDICTIONS DO NOT ALLOW THE EXCLUSION OR LIMITATION OF EXPRESS OR IMPLIED WARRANTIES, SO THE ABOVE EXCLUSION OR LIMITATION MAY NOT APPLY TO YOU. IN THAT EVENT SUCH WARRANTIES ARE LIMITED IN DURATION TO THE WARRANTY PERIOD. NO WARRANTIES APPLY AFTER THAT PERIOD.

Limitation of Liability

Circumstances may arise where, because of a default on IBM's part or other liability you are entitled to recover damages from IBM. In each such instance, regardless of the basis on which you are entitled to claim damages from IBM (including fundamental breach, negligence, misrepresentation, or other contract or tort claim), IBM is liable only for:

1. damages for bodily injury (including death) and damage to real property and tangible personal property; and
2. the amount of any other actual direct damages or loss, up to the greater of U.S. \$100,000 or the charges (if recurring, 12 months' charges apply) for the Machine that is the subject of the claim.

UNDER NO CIRCUMSTANCES IS IBM LIABLE FOR ANY OF THE FOLLOWING: 1) THIRD-PARTY CLAIMS AGAINST YOU FOR LOSSES OR DAMAGES (OTHER THAN THOSE UNDER THE FIRST ITEM LISTED ABOVE); 2) LOSS OF, OR DAMAGE TO, YOUR RECORDS OR DATA; OR 3) SPECIAL, INCIDENTAL, OR INDIRECT DAMAGES OR FOR ANY ECONOMIC CONSEQUENTIAL DAMAGES (INCLUDING LOST PROFITS OR SAVINGS), EVEN IF IBM OR YOUR RESELLER IS INFORMED OF THEIR POSSIBILITY. SOME JURISDICTIONS DO NOT ALLOW THE EXCLUSION OR LIMITATION OF INCIDENTAL OR CONSEQUENTIAL DAMAGES, SO THE ABOVE EXCLUSION OR LIMITATION MAY NOT APPLY TO YOU.

European Union (EU) Statement

This product has been tested and found to comply with the limits for Class B Information Technology Equipment according to CISPR 22 / European Standard EN 55022. The limits for Class B equipment were derived for typical residential environments to provide reasonable protection against interference with licensed communication devices.

Properly shielded and grounded cables and connectors must be used in order to reduce the potential for causing interference to radio and TV communications and to other electrical or electronic equipment. Such cables and connectors are available from IBM authorised dealers.

In accordance with EN 50082-1 1992, Performance Criterion A:, it should be noted that in the presence of certain electromagnetic fields, some screen jitter may be observed.

Spécifications de la CEE

Ce produit a été testé et déclaré conforme aux limites de la Classe B définies pour les équipements informatiques conformément à la norme européenne CISPR 22/EN 55022. Les limites imposées aux équipements de Classe B visent à garantir une protection raisonnable, dans des environnements résidentiels, contre toute interférence avec des équipements de communication agréés.

Des câbles blindés et correctement reliés à la terre doivent être utilisés pour réduire les risques d'interférence avec des communications radio et télévisées, ainsi qu'avec des équipements électriques ou électroniques. Ces câbles et connecteurs sont disponibles auprès de vos revendeurs IBM agréés.

Conformément à la norme EN 50082-1 1992, Performance Criterion A, veuillez noter qu'en

présence de certains champs électromagnétiques
l'image de l'écran peut être instable.

Erklärung für die Europäische Union (EU)

Dieses Produkt wurde getestet, und dabei wurde festgestellt, daß es gemäß CISPR 22 / Europäische Norm EN 55022 die Grenzwerte für Ausrüstung der Informationstechnik, Klasse B, einhält. Die Grenzwerte für Ausrüstung der Klasse B wurden für eine typische Wohnumgebung erarbeitet, um einen angemessenen Schutz vor Störungen im Zusammenhang mit zugelassenen Kommunikationsgeräten zu gewährleisten.

Es sind ordnungsgemäß abgeschirmte und geerdete Kabel und Stecker zu verwenden, um das Störungspotential in bezug auf Radio- und Fernsehempfang oder andere elektrische oder elektronische Geräte zu reduzieren. Solche Kabel

und Stecker sind bei autorisierten IBM-Fachhändlern erhältlich.

In Übereinstimmung mit EN 50082-1 1992, Leistungskriterium A wird darauf hingewiesen, daß bestimmte elektromagnetische Felder ein Flattern auf dem Bildschirm hervorrufen können.

Declaración de la Unión Europea (UE)

Este producto ha sido probado y cumple con las limitaciones estipuladas para la Clase B ITE (Information Technology Equipment), de conformidad con CISPR 22 / Estándar Europeo EN 55022. Las limitaciones de los equipos de Clase B se establecieron para que los entornos residenciales típicos a fin de proporcionar una protección razonable contra interferencias con dispositivos de comunicación autorizados.

Se deben utilizar conectores y cables debidamente protegidos y conectados a tierra a fin de reducir las posibilidades de que se produzcan interferencias con comunicaciones por radio o televisión y otros equipos eléctricos o electrónicos. Este tipo de cables y conectores pueden adquirirse en concesionarios autorizados de IBM.

De acuerdo con la norma EN 50082-1 1992, Performance Criterion A, habría que destacar que en presencia de determinados campos electromagnéticos, podría observarse una marcada inestabilidad e la imagen.

Dichiarazione di conformità dell'Unione Europea (UE)

Questo prodotto è stato collaudato e trovato conforme ai limiti di Classe B relativi agli apparecchi informatici secondo quanto dispone la normativa

europea CISPR 22 / EN 55022. I limiti degli apparecchi di Classe B sono stati definiti per i normali ambienti domestici al fine di fornire un'adeguata protezione con dispositivi di comunicazione autorizzati.

Utilizzare cavi e connettori collegati a terra per ridurre il rischio potenziale di interferenza delle comunicazioni radiotelevisive e di altri apparecchi elettrici o elettronici. I cavi sono disponibili presso i rivenditori autorizzati IBM.

In accordo con quanto previsto nel documento EN 50082-1 1992, Performance Criterion A, è importante sottolineare che in presenza di determinati campi elettromagnetici è possibile che si verifichi un certo tremolio delle immagini.

IBM Warranty Statement - Europe

IBM warrants this IBM product to be in good working order and conforms to its officially published IBM specifications for a period of three years from the date of first purchase by an end-user customer.

Note:

Batteries for Mobile products are limited to 1 year warranty.

Your sales receipt or authorised dated and stamped warranty service certificate is proof of your entitlement to warranty service.

If this product is not in good working order, IBM will, at its option, repair or replace this product at no additional charge except as set forth below. Repair parts and replacement products will be provided on an exchange basis and will be either new, equivalent to new or reconditioned. All replaced parts and products become the property of IBM. This warranty does not cover the repair of damage to the product resulting from:

1. Accident, disaster, misuse and abuse.
2. Use of parts not manufactured or sold by IBM
3. Modification of the product
4. Service provided by anyone other than IBM or an authorised IBM service provider.

IBM does not warrant that the functions in any preloaded program will meet your requirements or that the operations of the preloaded program will be uninterrupted or error free.

There is no other warranty whether express or implied. In case the exclusion of certain warranties would be precluded by applicable law, such warranties would be limited in duration to the warranty period stated above.

WarrantyPerformance

Warranty service may be obtained by returning the product during warranty period to an authorised IBM service provider and by providing proof of your warranty service entitlement. You are responsible for any associated transportation charges and insurance during shipment and return.

For a product purchased in a group A country (as defined), warranty service may be obtained from any authorised IBM service provider in any group A country; similarly for a product purchased in a group B country, warranty service may be obtained from any authorised IBM service provider in any group B country.

Group A Countries

Austria, Belgium, Denmark, Finland, France, Germany, Greece, Iceland Italy, Ireland, Luxembourg, Netherlands, Norway, Portugal, Spain, Sweden, Switzerland and United Kingdom.

Group B Countries

Albania, Bosnia-Herzegovina, Bulgaria, Croatia, Czechia, Russia, Armenia, Bellarus, Georgia, Kirghizia, Hungary, Kazakhstan, Macedonia, Moldova, Poland, Romania, Slovakia, Serbia-Montenegro, Slovenia, Ukraine.

On-SiteService

Some IBM products are sold with a service entitlement which is delivered on the customers premises (on-site).If the product you have purchased carries with it an entitlement to IBM on-site service, this service is provided during the warranty period subject to the following terms and conditions:

The product must have been announced as qualifying for On-Site Service in the country in which Warranty Service is being claimed.

You must contact a local authorised IBM service provider and beprepared to supply proof of warranty entitlement.The authorised IBM service provider will attempt to resolve your problem over the telephone. If this is not possible, a trained service engineer will be dispatched to your location to repair the IBM product.

The service representative must be provided with full access to the equipment reported as faulty.

The equipment must be located within 50 kilometers (or more depending on country) of the authorised IBM service provider.

Liability

IBM shall have no liability for lost profits or other consequential damages, even if advised of the possibility of such damages, or for any claim by any third party. IBM?s total liability for a breach or breaches of this warranty by IBM is limited to 100,000 US Dollars of direct damages.This financial limitation of liability will not apply to claims for death or personal injury or damage to real or personal property caused by IBM negligence.

General

No statements contained herein shall affect the statutory rights of consumers.

International Warranty Service

IBM International hardware warranty service is available for those customers, travelling to countries in which their PC products are announced and sold by IBM or IBM resellers, upon registering with IBM International Warranty Service Office. IBM International Warranty Service is provided subject to the terms and conditions of the IBM Warranty Statement provided with the product in the country of purchase. Service outside the country of purchase will be provided under local service procedures. Customers who wish to relocate their machine to another country and wish to obtain warranty service must first register with the International Warranty Service Office based in Greenock. The I.W.S.O. will offer advice on the warranty service available in the country or countries where the customer wishes to relocate and will issue an International Warranty Service Certificate upon proof of warranty status of the customers machine.

Contact the I.W.S.O. on

Tel + 44 1475 893638

Fax + 44 1475 893732

Alternatively customers may register for International Warranty Service via their local IBM Office.

Notes:

1. International Warranty Service is not available on IBM Options unless they are installed in or connected to an IBM System Unit which is registered for International Warranty Service.
2. Customers are not required to register their machine for International Warranty Service if relocation is within the countries of Group A or Group B.

Service Information

The following parts are for use by IBM service, or IBM authorized dealers, to support customer warranty. Parts are for service use only.

G54 Model Type 6546

11L2908	6546-0AN	Monitor – UVNH (Pearl White)
11L2909	6546-4AN	Monitor – UVNH (Stealth Gray)
11L2839	6546-0AE	Monitor – UVEQ (Pearl White)
11L2840	6546-4AE	Monitor – UVEQ (Stealth Gray)
11L2932		Tilt/Swivel
11L2933		Tilt Swivel (Stealth Gray)

G74 Model Type 6547

11L2914	6547-0AN	Monitor – UVNH (Pearl White)
11L2915	6547-4AN	Monitor – UVNH (Stealth Gray)
11L2853	6547-0AE	Monitor – UVEQ (Pearl White)
11L2854	6546-4AE	Monitor – UVEQ (Stealth Gray)
11L2934		Tilt/Swivel
11L2935		Tilt Swivel (Stealth Gray)