



*Personal Computer
Hardware Reference
Library*

Guide to Operations

Revised Edition (April 1984)

This product could include technical inaccuracies or typographical errors. Changes are periodically made to the information herein; these changes will be incorporated in new editions of the publication.

It is possible that this material may contain references to, or information about, IBM products (machines and programs), programming or services that are not announced in your country. Such references or information must not be construed to mean that IBM intends to announce such IBM products, programming, or services in your country.

Products are not stocked at the address below. Requests for copies of this product and for technical information about the system should be made to your authorized IBM Personal Computer dealer.

The following paragraph applies only to the United States and Puerto Rico: A Reader's Comment Form is provided at the back of this publication. If the form has been removed, address comments to: IBM Corp., Personal Computer, P.O. Box 1328-C, Boca Raton, Florida 33432. IBM may use or distribute any of the information you supply in any way it believes appropriate without incurring any obligations whatever.

© Copyright International Business Machines Corporation, 1981, 1982, 1983, 1984

FEDERAL COMMUNICATIONS COMMISSION RADIO FREQUENCY INTERFERENCE STATEMENT

Warning: The equipment described herein has been certified to comply with the limits for a Class B computing device, pursuant to Subpart J of Part 15 of FCC rules. Only peripherals (computer input/output devices, terminals, printers, etc.) certified to comply with the Class B limits may be attached to this computer. Operation with noncertified peripherals is likely to result in interference to radio and TV reception. If peripherals not offered by IBM are used with the equipment, it is suggested to use shielded grounded cables with in-line filters if necessary.

INSTRUCTIONS TO USER

This equipment generates and uses radio frequency energy and if not installed and used properly, i.e., in strict accordance with the operating instructions, reference manuals, and the service manual, may cause interference to radio or TV reception. It has been tested and found to comply with the limits for a Class B computing device pursuant to Subpart J of Part 15 of FCC rules, which are designed to provide reasonable protection against such interference when operated in a residential installation.

If this equipment does cause interference to radio or TV reception, which can be determined by turning the equipment off and on, the user is encouraged to try to correct the interference by one or more of the following measures:

- Reorient the receiving antenna.
- Relocate the equipment with respect to the receiver.
- Move the equipment away from the receiver.
- Plug the equipment into a different outlet so that equipment and receiver are on different branch circuits.
- Ensure that card mounting screws, attachment connector screws, and ground wires are tightly secured.
- Ensure that card slot covers are in place when no card is installed.
- If peripherals not offered by IBM are used with this equipment, it is suggested to use shielded, grounded cables, with in-line filters if necessary.

If necessary, consult your dealer service representative for additional suggestions.

The manufacturer is not responsible for any radio or TV interference caused by unauthorized modifications to this equipment. It is the responsibility of the user to correct such interference.

CAUTION

This product is equipped with a line cord and plug for the user's safety. It is to be used in conjunction with a properly grounded receptacle to avoid electrical shock.

Preface

The *Guide to Operations* manual provides the information you need to install and operate your IBM Personal Computer XT, and to diagnose and correct many problems that may occur. The manual consists of six sections, each with an external tab to help you find the section you want. A description of each section follows.

SECTION 1, INTRODUCTION AND INSTALLATION, provides a brief description of the system unit, keyboard, printers, expansion unit, and displays. It also shows a typical system arrangement. Cabling of the system is shown, and the power-on self test is described.

SECTION 2, PROBLEM DETERMINATION PROCEDURES, describes the steps to correct problems that may occur.

SECTION 3, OPERATING YOUR PERSONAL COMPUTER XT, shows the location and describes the operation of the power switches, describes the keyboard, and explains the operation of the various units of the system.

SECTION 4, OPTION INSTALLATION, is where you file the installation instructions that come with any option you purchase for your system. This section also has charts showing how to set switches for your particular system arrangement.

SECTION 5, MOVING YOUR IBM PERSONAL COMPUTER XT, describes how to prepare your system when you have to move it.

SECTION 6, TEMPLATES, provides graphic layouts of keyboards for use with international keyboards and National DOS.

A glossary of terms and abbreviations used in the manual is also included.

Contents

SECTION 1. INTRODUCTION AND INSTALLATION	1-1
Introduction	1-3
Example of a System Arrangement	1-4
Option Examples	1-5
Handling Diskettes	1-7
Installation	1-9
System Cabling	1-14
Keyboard Tilt Adjustment	1-15
Power-On Self Test	1-16
Screen Alignment Procedure	1-20
Summary	1-24
SECTION 2. PROBLEM DETERMINATION PROCEDURES	2-1
SECTION 3. OPERATING YOUR IBM PERSONAL COMPUTER XT	3-1
System Unit	3-3
Keyboard	3-5
The Typewriter Area	3-6
The Numeric Keypad	3-10
Function Keys	3-14
Diskette Drive	3-15
Expansion Unit	3-17
IBM Monochrome Display	3-18
IBM Color Display	3-19
Power-On Control	3-19
Contrast Control	3-19
Brightness Control	3-19
Vertical Hold Control	3-20
Vertical Size Control	3-21
SECTION 4. OPTION INSTALLATION	4-1
How to Use This Section	4-3
Handling Static-Sensitive Devices	4-4
System Board Switches	4-7

Coprocessor	4-8
Memory	4-8
Displays	4-9
5-1/4 Inch Diskette Drives	4-10
Memory Option Switches	4-11
288K Total Memory	4-11
320K Total Memory	4-11
352K Total Memory	4-12
384K Total Memory	4-13
416K Total Memory	4-14
448K Total Memory	4-15
480K Total Memory	4-16
512K Total Memory	4-17
544K Total Memory	4-18
576 Total Memory	4-19
608 Total Memory	4-20
640K Total Memory	4-21
Extender Card Switches	4-22

SECTION 5. MOVING YOUR IBM PERSONAL

COMPUTER XT	5-1
Preparing the System	5-3
Short Distance Move	5-8
Long Distance Move	5-9
All Units	5-9
System Unit	5-9
Expansion Unit	5-10
Keyboard	5-11
IBM Monochrome or Color Display ..	5-12
IBM Graphics Printer	5-13
Installation at New Location	5-14

SECTION 6. KEYBOARD TEMPLATES

Introduction	6-3
French	6-5
German	6-7
Italian	6-9
Spanish	6-11
U.K. English	6-13
U.S. English	6-15

GLOSSARY

Glossary-1

INDEX Index-1

Notes:

SECTION 1. INTRODUCTION AND INSTALLATION

Contents

Introduction	1-3
Example of a System Arrangement	1-4
Option Examples	1-5
Handling Diskettes	1-7
Installation	1-9
System Cabling	1-14
Keyboard Tilt Adjustment	1-15
Power-On Self Test	1-16
Screen Alignment Procedure	1-20
Summary	1-24

Notes:

Introduction

The basic IBM Personal Computer XT consists of a system unit and keyboard. The system unit has a 10M-byte fixed disk drive, a dual-sided diskette drive, an Asynchronous Communications Adapter, 128K bytes of memory, and five expansion slots. The keyboard, which is what you use to send data to your system, attaches to the system unit with a 2-meter (6-foot) coiled cable. The keyboard consists of three major sections: the typewriter area, the numeric keypad, and the function keys.

You can add various options to your system—a display, a printer, an expansion unit, a fixed disk drive, memory, and more.

The IBM Personal Computer XT is designed for use with monitors or televisions that meet either the National Television System Committee (NTSC)¹ or the Electronics Industry Association (EIA) RS 170 standards. Therefore, if your device does not meet these standards, it may not function properly.

Several printers are available for printout or hard-copy of your data files. The IBM Graphics Printer and the IBM Color Printer provide bidirectional printing in several character sizes on single- or multi-part forms. A Compact Printer is also available at a very attractive price.

The expansion unit provides space for additional options to be attached to your IBM Personal Computer XT. The expansion unit comes equipped with a 10M-byte fixed disk drive and after installation, contains two 10M-byte fixed disk drives and six available expansion slots.

¹ The National Television System Committee has set United States broadcast standards.

Example of a System Arrangement

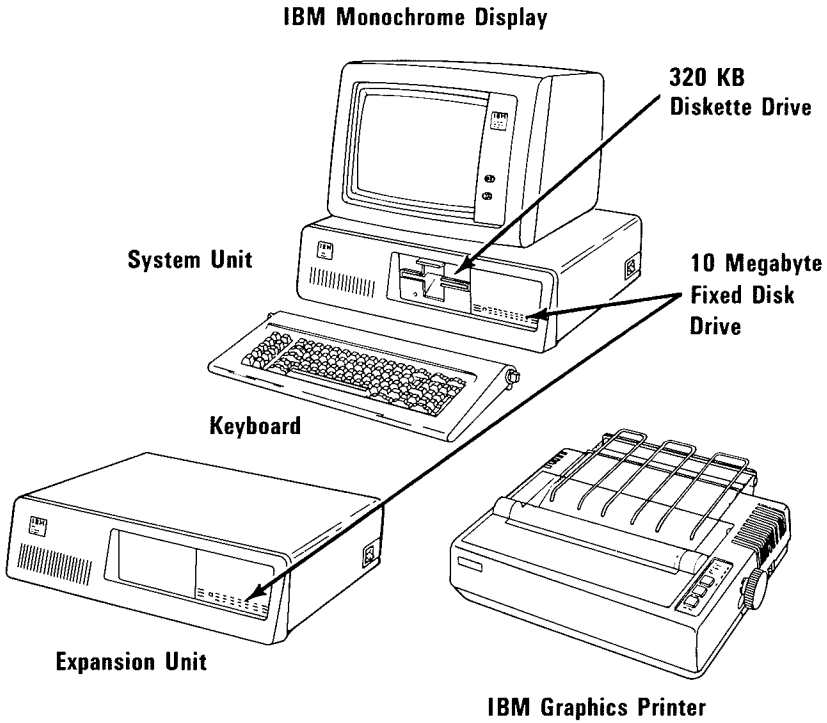

Option Examples

These are options which you can add externally to your system.

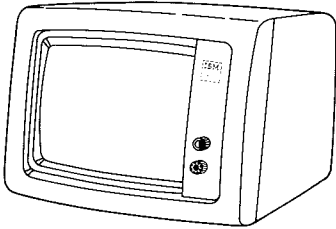

IBM Monochrome Display

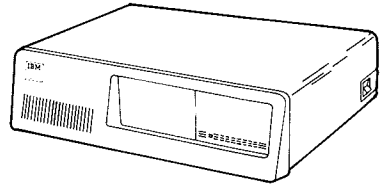

Expansion Unit

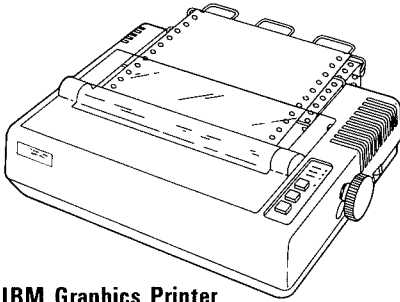

IBM Graphics Printer

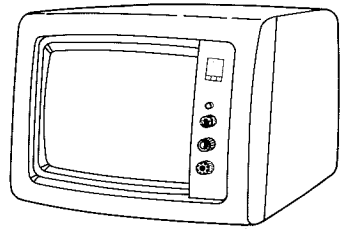

IBM Color Display

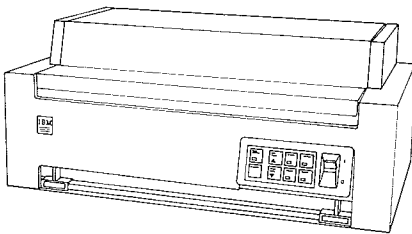

IBM Color Printer

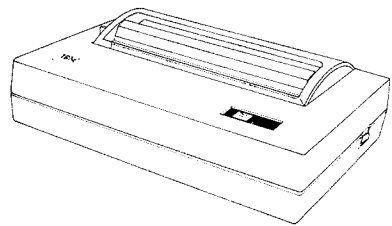

IBM Compact Printer

Option Examples

These are some of the options which you can install in your system unit or expansion unit.

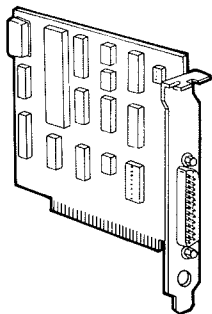

Asynchronous Communications Adapter

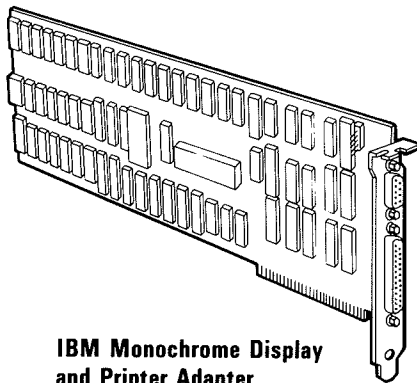

IBM Monochrome Display and Printer Adapter

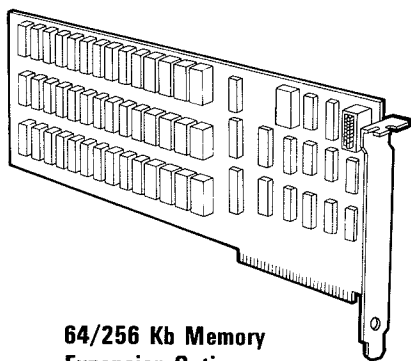

64/256 Kb Memory Expansion Option

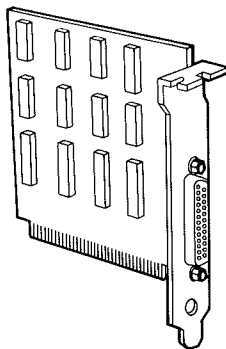

Printer Adapter

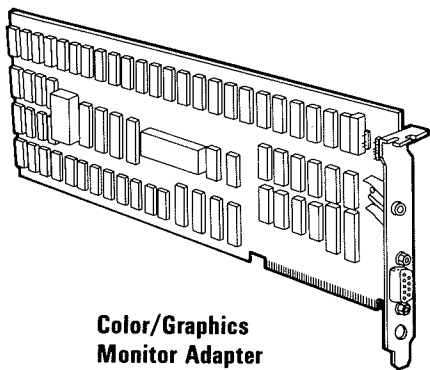

Color/Graphics Monitor Adapter

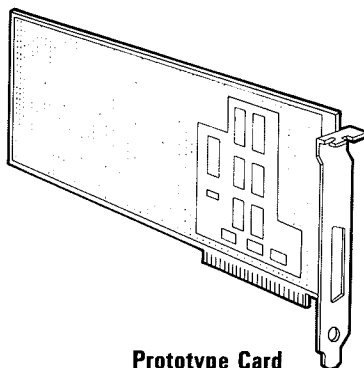

Prototype Card

Handling Diskettes

The figures below show some proper and improper ways of handling your diskettes. Proper handling greatly reduces the possibility of damage.

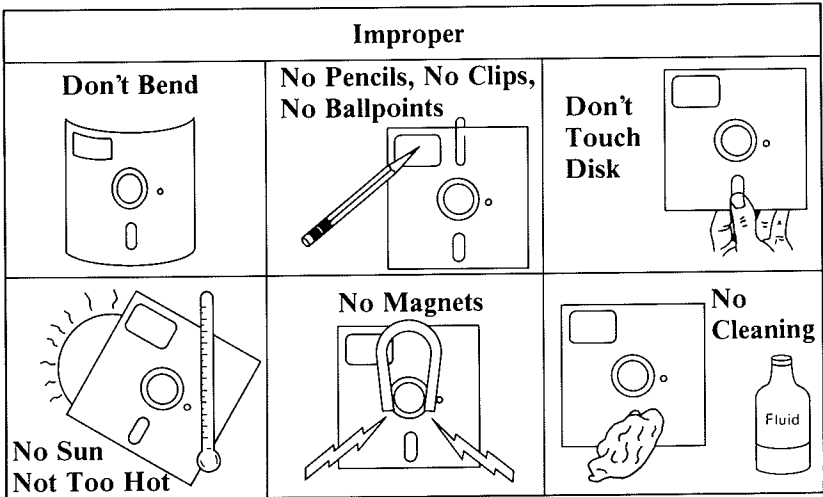
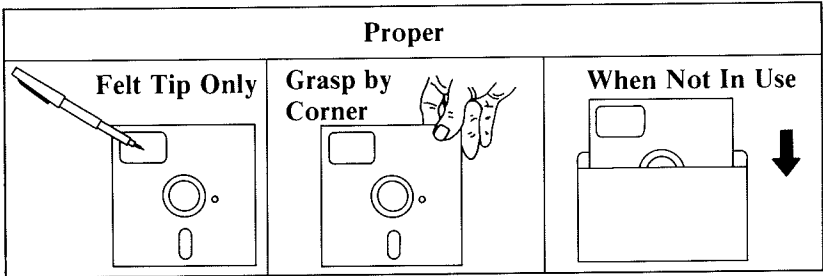

Notes:

1-8 Introduction

Installation

To install your IBM Personal Computer XT, do the following.

- 1 Remove the tape from the diskette drive.

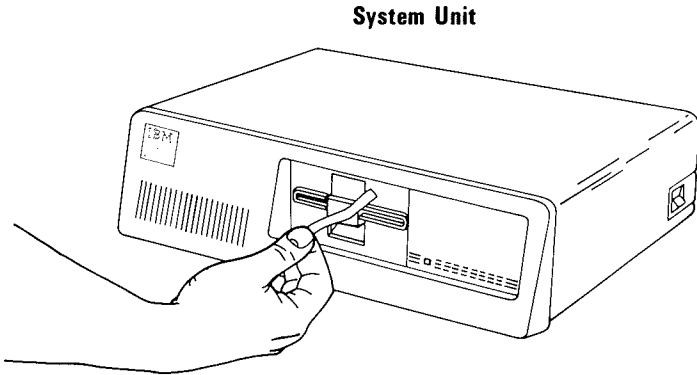

- 2 Remove the shipping cardboard.

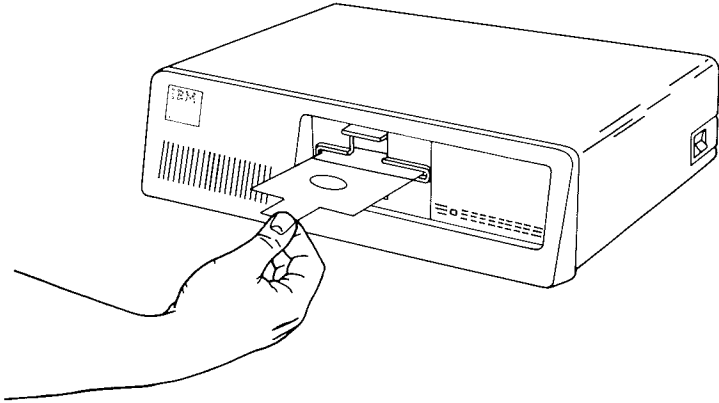

Note: Save the shipping cardboard. You may need it to insert into the diskette drive if you transport your system in the future.

- 3** Place the system unit in the position shown.

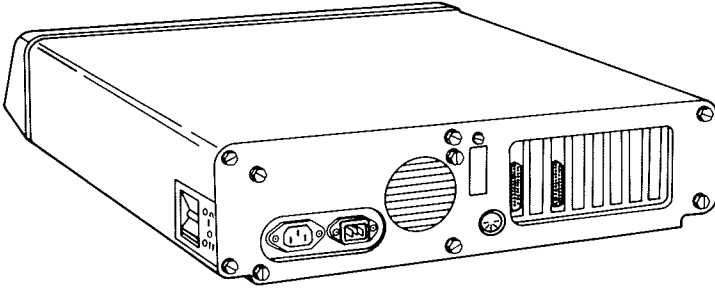

- 4** Connect the keyboard cable to the system unit.

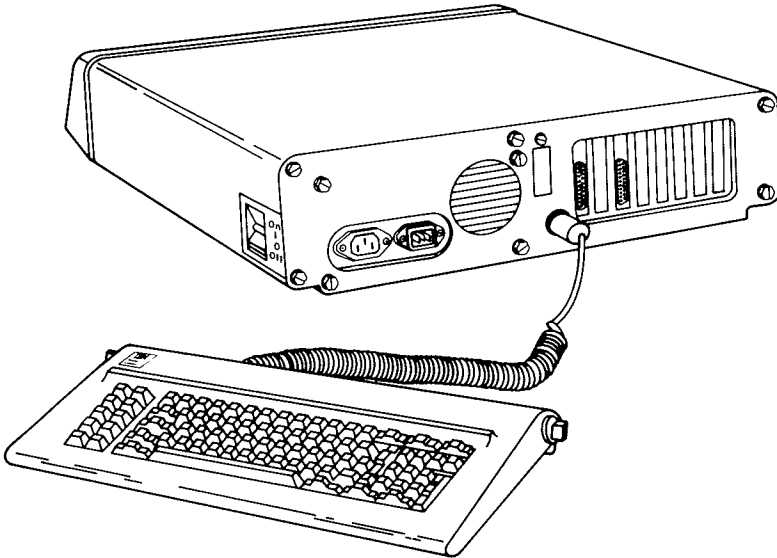

- 5** Set the system unit's Power switch to Off.

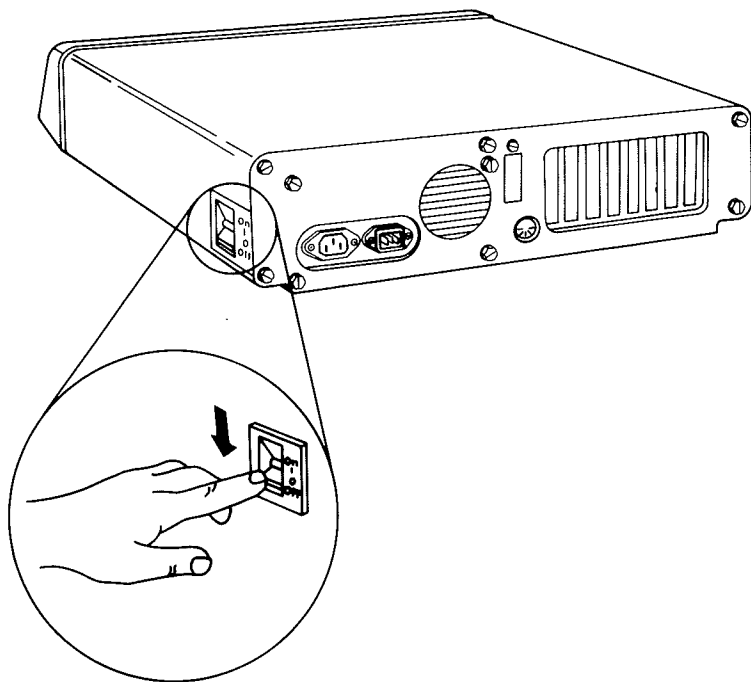

| Is the International symbol for On.

○ Is the International symbol for Off.

- 6** Connect the system power cord to the system unit, then to the wall outlet.

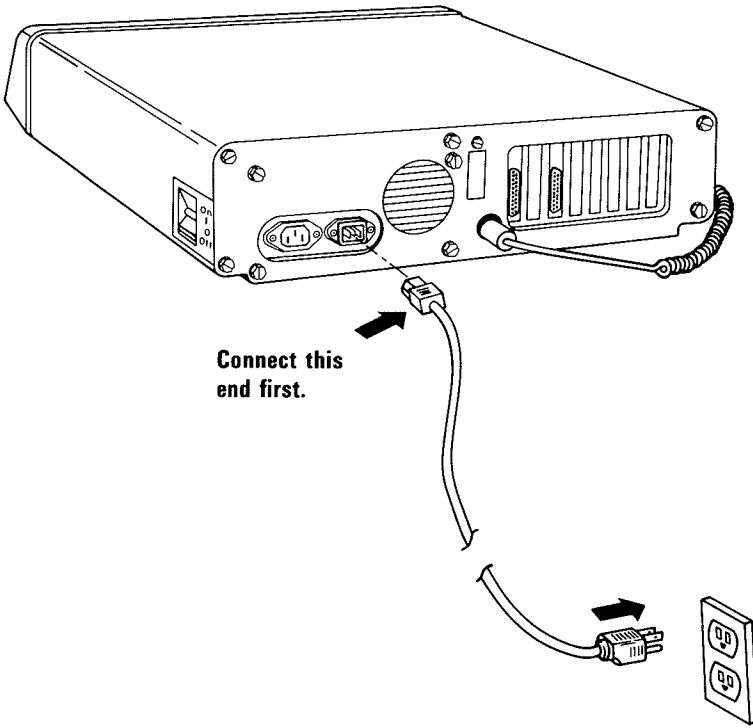

CAUTION

This product is equipped with a line cord and plug designed for the user's safety. It is to be used with a properly grounded power receptacle to avoid possible electrical shock.

7

Set the Power switch to On. You should hear one short beep after a short system test.

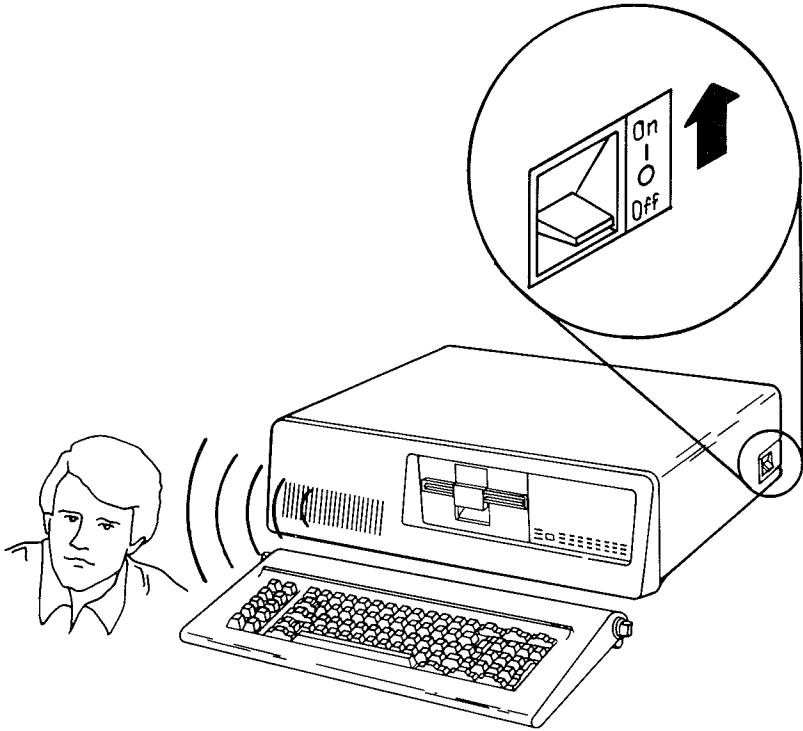

If you do not hear the short beep, check the wall outlet by plugging in a working lamp. If the lamp lights, return your IBM Personal Computer XT to your place of purchase.

If you hear the short beep, your system unit has completed its self-test.

You are now ready to install your options. Be sure to read "Handling Static-Sensitive Devices" in the "Option Installation" section of this manual before installing an option in your IBM Personal Computer XT. If your options are already installed, continue with "System Cabling."

System Cabling

Connect your cables and Power cords to the system unit, as shown in the following figure.

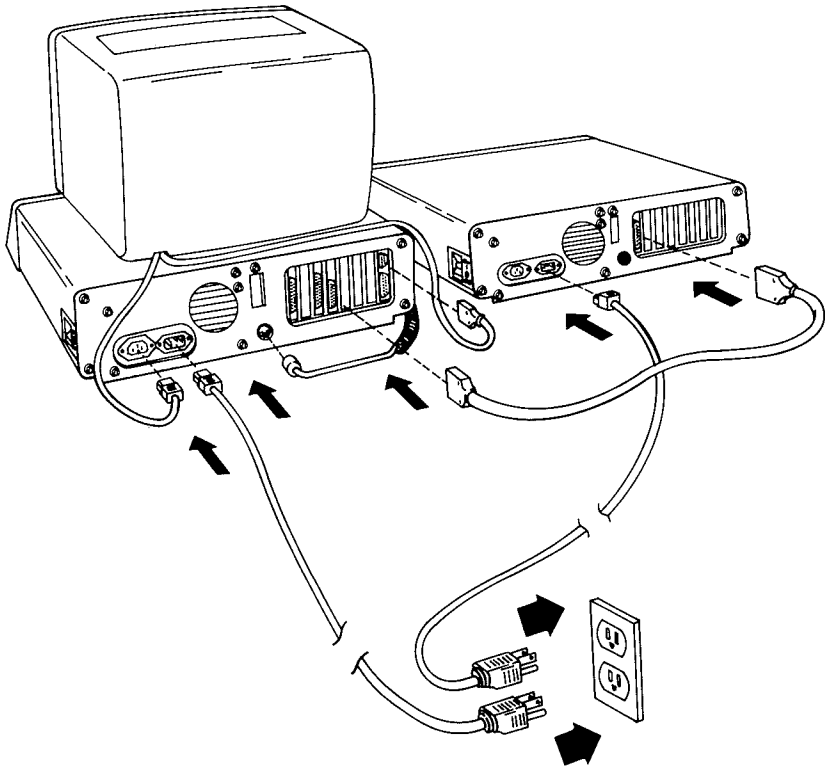

CAUTION

This product is equipped with a line cord and plug designed for the user's safety. It is to be used with a properly grounded power receptacle to avoid possible electrical shock.

Note: If you are using your TV or a non-IBM display, you could experience data errors while using your diskette drive. This interference can easily be corrected by moving your TV or display at least 30 cm (12 inches) away from your IBM Personal Computer XT.

Keyboard Tilt Adjustment

The tilt of the keyboard can be adjusted for your typing comfort. To adjust the tilt, hold the keyboard, firmly push in the adjustable foot handles and turn them to the desired tilt position, as shown below.

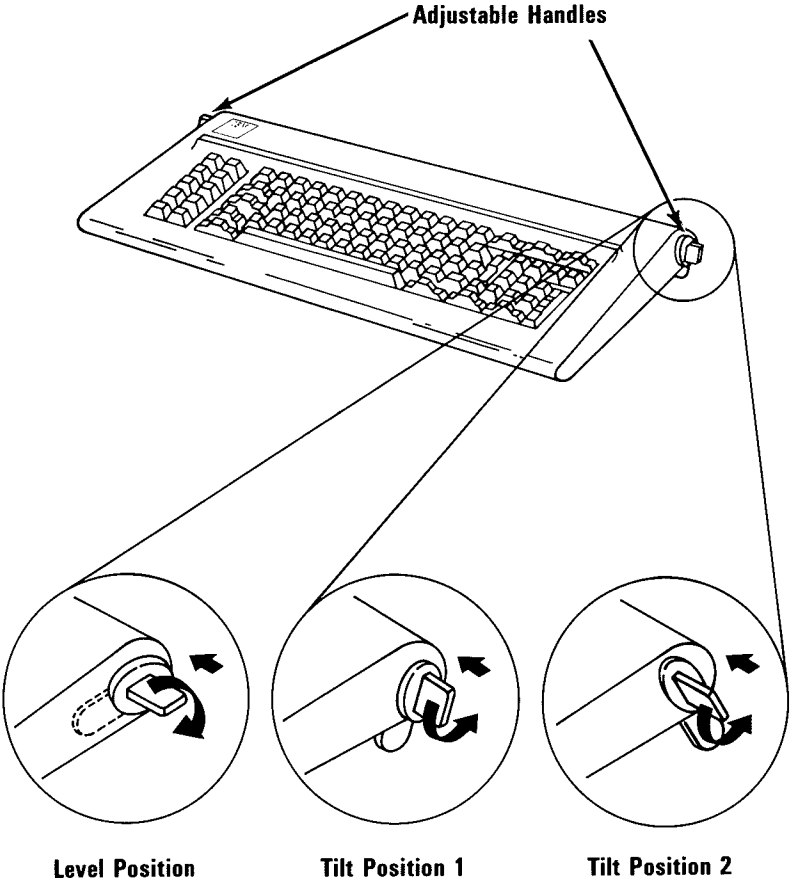

Note: Tilt position 1 may not be available on your keyboard.

Power-On Self Test

The power-on self test (POST) is done each time your system's power is switched on. The POST takes 13 to 90 seconds, depending on the amount of memory in your system.

- 1** Turn the Contrast and Brightness controls on your display or TV fully clockwise.
- 2** Switch on the power to all attached devices (printer, TV, etc.).
- 3** Set the Power switch on the expansion unit (if attached) to On.
- 4** Set the Power switch on the system unit to On. There are normally three responses.
 - A** An indication of the memory test appears in the upper-left corner of your screen. The number should continue to increase until it equals the amount of memory in your system.



XXX KB OK

- B** One short beep is heard at the end of the POST.

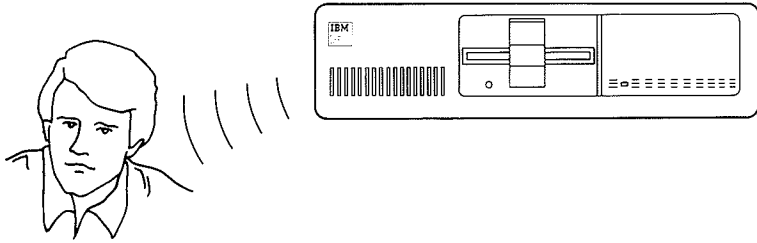

- C** The IBM Personal Computer BASIC message and a blinking cursor appear unless a program from a diskette, or an operating system from the fixed disk drive, is loaded. Then the first presentation of the program or operating system appears.

**The IBM Personal Computer Basic
Version CX.XX Copyright IBM Corp. XXXX
XXXXX Bytes free
Ok**

1LIST 2RUN 3LOAD" 4SAVE 5CONT 6LPT1 '7TRON 8TROFF 9KEY 0SCREEN

If the responses are not correct, go to "Problem Determination Procedures."

Note: If you are using your TV or a non-IBM display, and the screen image is similar to the one below, the screen needs alignment. The procedure for doing this appears later in this section. For now, continue with Step 5.

IBM Personal Computer Basic
Version X.XX Copyright IBM Corp. XXXX
XXXX Bytes Free

1ST 2RUN 3LOAD 4SAVE 5CONT 6LPT1 7TRON 8TROFF 9KEY 0SCREEN

- 5** Adjust the Contrast and Brightness controls for eye comfort.

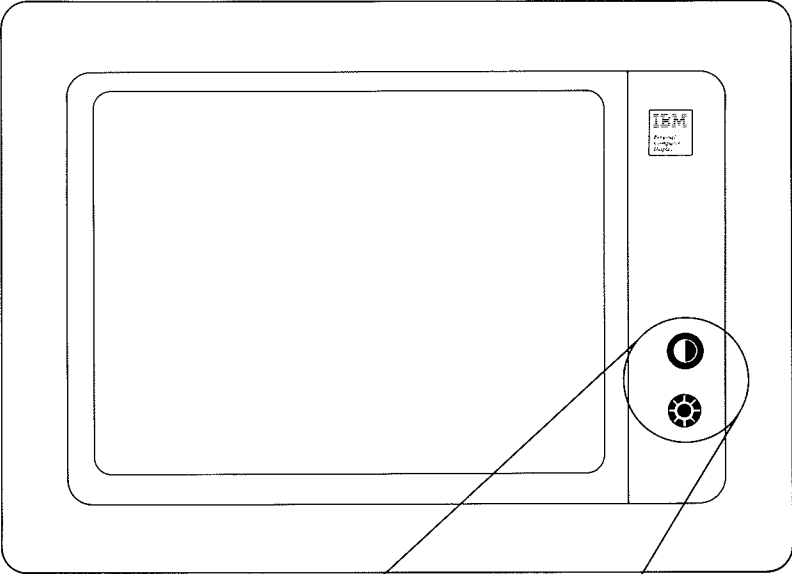

IBM Monochrome Display

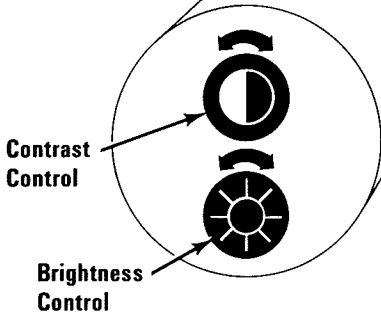

Screen Alignment Procedure

- 1** Remove the Diagnostics diskette from the back of this manual.

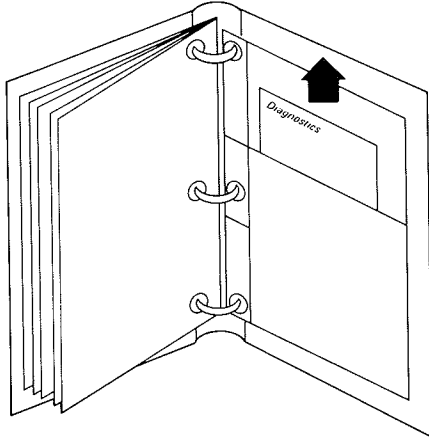

- 2** Set the Power switch on the system unit (and expansion unit, if attached) to Off.
- 3** Set the Power switches on all attached devices to Off (printer, TV, etc.).

- 4 Lift the load lever on the diskette drive.
- 5 Insert the Diagnostics diskette.
- 6 Push the load lever down.
- 7 Switch on power to all attached devices.
- 8 If an expansion unit is attached, set its Power switch to On.
- 9 Set the system unit's Power switch to On.

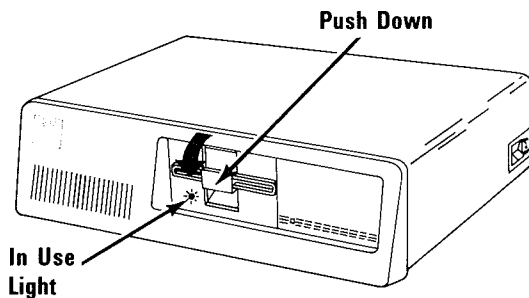
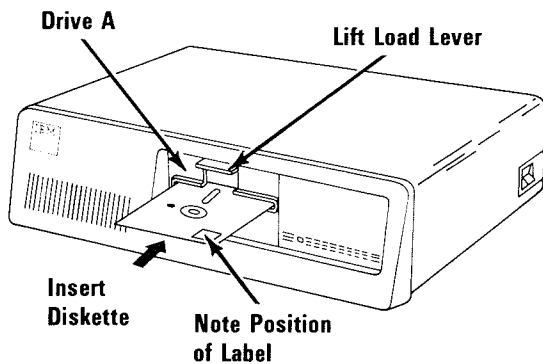



Note: If you are using your TV or a non-IBM display, and the screen image is similar to the one below, do the step on the next page to correct the problem.

e IBM Personal Computer DIAGNOSTICS
rsion X.XX (C) Copyright IBM Corp XXXX

LECT AN OPTION

- RUN DIAGNOSTIC ROUTINES
- FORMAT DISKETTE
- COPY DISKETTE
- PREPARE SYSTEM FOR RELOCATION
- EXIT TO SYSTEM DISKETTE

TER THE ACTION DESIRED

- 10** Press function key  to move the information on the screen to the right, or function key  to move the information to the left.

Your screen should match the figure below. If not, go to “Problem Determination Procedures.”

**The IBM Personal Computer DIAGNOSTICS
Version X.XX (C) Copyright IBM Corp XXXX
SELECT AN OPTION
0 - RUN DIAGNOSTIC ROUTINES
1 - FORMAT DISKETTE
2 - COPY DISKETTE
3 - PREPARE SYSTEM FOR RELOCATION
9 - EXIT TO SYSTEM DISKETTE
ENTER THE ACTION DESIRED
?**

Summary

You now have installed and arranged your IBM Personal Computer XT. You also have learned how to perform the power-on self test (POST) and what responses to expect after a successful POST. You know the proper way to handle diskettes and how to align your screen. Now you are ready to give your system a complete diagnostic test, which you should do whenever you cable your system or install an option.

Now turn to “Problem Determination Procedures” and give your system a complete diagnostic test.

SECTION 2. PROBLEM DETERMINATION PROCEDURES

Introduction

If you experience a problem with either your IBM Personal Computer or IBM Personal Computer XT, the problem determination procedures will help you find which unit in your system is failing. The procedures also can be used to check that your system is operating correctly. Simply follow the step-by-step instructions and answer yes or no to the questions asked.

As part of the problem determination, you may have to use the Diagnostics diskette, which is at the back of the manual. The diskette has a series of tests that check the five units of your system—system unit, expansion unit, keyboard, display, and printer—as well as other installed options. The tests are performed in sequence. As one test finishes successfully, the next one automatically starts.

Note: If you have a non-U.S. English keyboard and use the diskette in the back of this manual, use a U.S. English keyboard template.

For a screen-alignment problem, start on the following page. To do a complete system check or find the cause of a problem, start with “Checking Electrical Connections” on page Start 20-1.

Other Options

Some options may have separate manuals. For a description of problem diagnosis, go to that option's manual.

Notes:

Screen Alignment Procedure

- 1 Remove the Diagnostics diskette from the back of this manual.

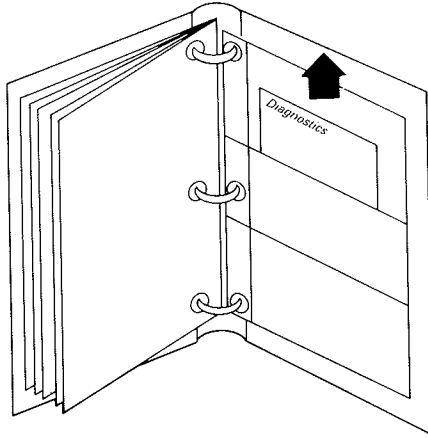

- 2 Set the Power switch on the system unit (and expansion unit, if attached) to Off.

| Is the International symbol for On.

○ Is the International symbol for Off.

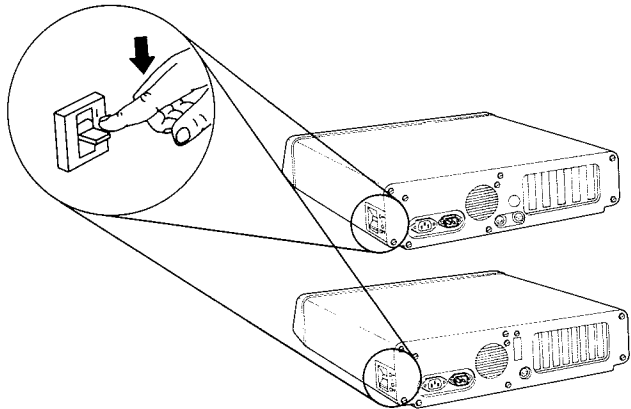

- 3** Set the Power switches on all attached devices to Off.
- 4** Lift the diskette-drive load lever.
- 5** Insert the Diagnostics diskette into drive A.

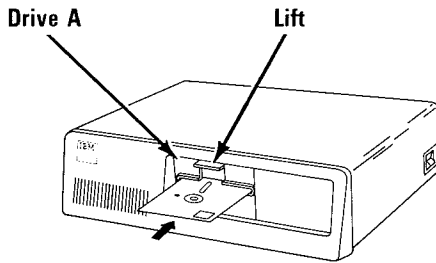

- 6** Push the load lever down.

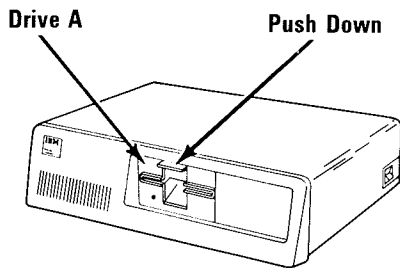

- 7 Set the Power switches on all attached devices to On.
- 8 If an expansion unit is attached, set its Power switch to On.
- 9 Set the system unit's Power switch to On.

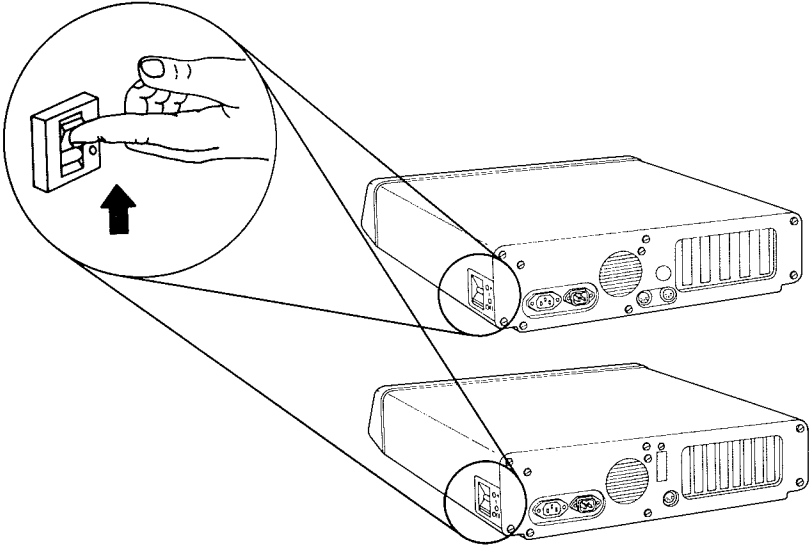

If you are using your TV or a non-IBM display with your system, and its screen image is similar to the one below, do the step following the figure to correct the problem.



Note: If the alignment on any IBM display is incorrect, have it serviced.

e IBM Personal Computer DIAGNOSTICS
rsion X.XX (C) Copyright IBM Corp XXXX

LECT AN OPTION

- RUN DIAGNOSTIC ROUTINES
- FORMAT DISKETTE
- COPY DISKETTE
- PREPARE SYSTEM FOR RELOCATION
- EXIT TO SYSTEM DISKETTE

TER THE ACTION DESIRED

- 10** Press function key  to move the presentation to the right, or  to move the presentation to the left, as appropriate.

Your screen should match the one shown in the figure below. If it does, remove the Diagnostics diskette and return it to the back of the manual. If not, have your TV or non-IBM display serviced.

**The IBM Personal Computer DIAGNOSTICS
Version XXX (C) Copyright IBM Corp XXXX, XXXX**

SELECT AN OPTION

- 0 - RUN DIAGNOSTIC ROUTINES**
- 1 - FORMAT DISKETTE**
- 2 - COPY DISKETTE**
- 3 - PREPARE SYSTEM FOR RELOCATION**
- 9 - EXIT TO SYSTEM DISKETTE**

ENTER THE ACTION DESIRED

?

Continue with the next Test.

Notes:

Checking Electrical Connections

- 1** Set the Power switch on the system unit (and expansion unit, if attached) to Off.
- 2** Set the Power switches on all attached devices to Off.
- 3** Disconnect all devices.
- 4** Unplug the system unit's (and expansion unit's) power cord from the wall outlet.

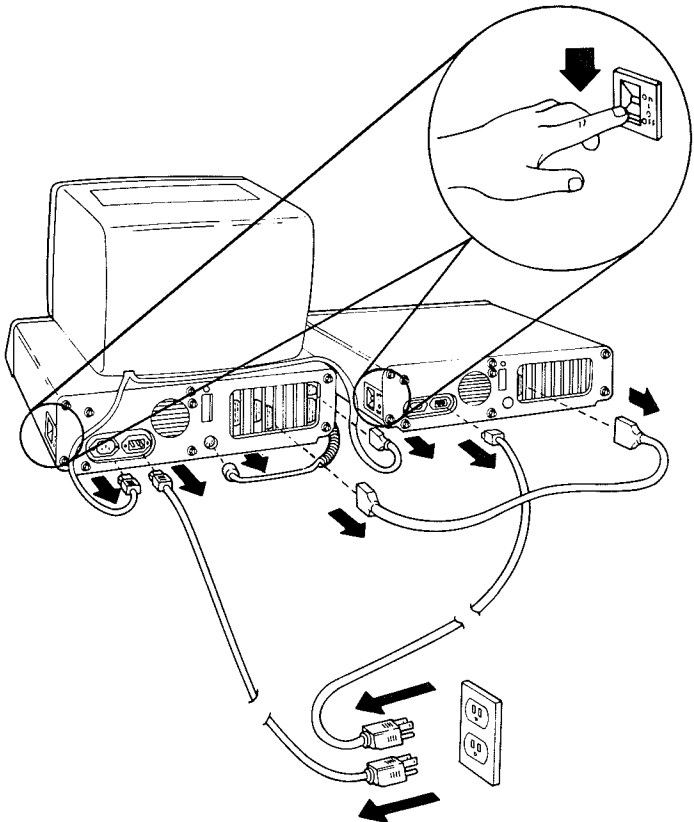

- 5** Check the wall outlet by plugging in a working lamp.

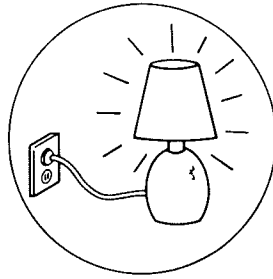

Outlet O.K.

- 6** Connect each cable to the proper connector on the system unit (and expansion unit, if attached) to ensure correct electrical connection.
- 7** Plug the system unit's (and expansion unit's) power cord into the wall outlet.

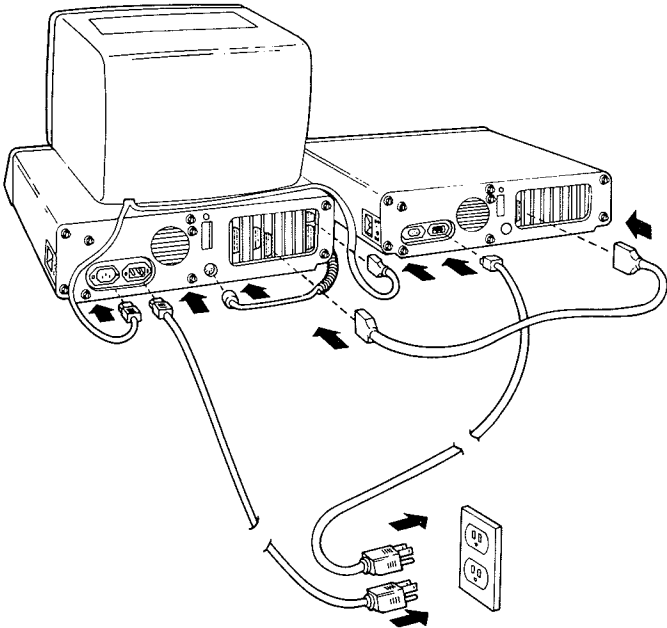

Note: If you do not have an IBM Communications Adapter Cable attached to your system unit, go to the next page.

8 If you have an IBM Communications Adapter Cable, it came with a wrap plug. Disconnect the Communications Adapter Cable at the modem end (refer to the Communications Adapter Cable's "Option Installation Instructions" for the cable-removal procedure).

9 See the figure below and install the wrap plug (IBM part number 8529280) on the modem end of the cable (end farthest from the system unit).

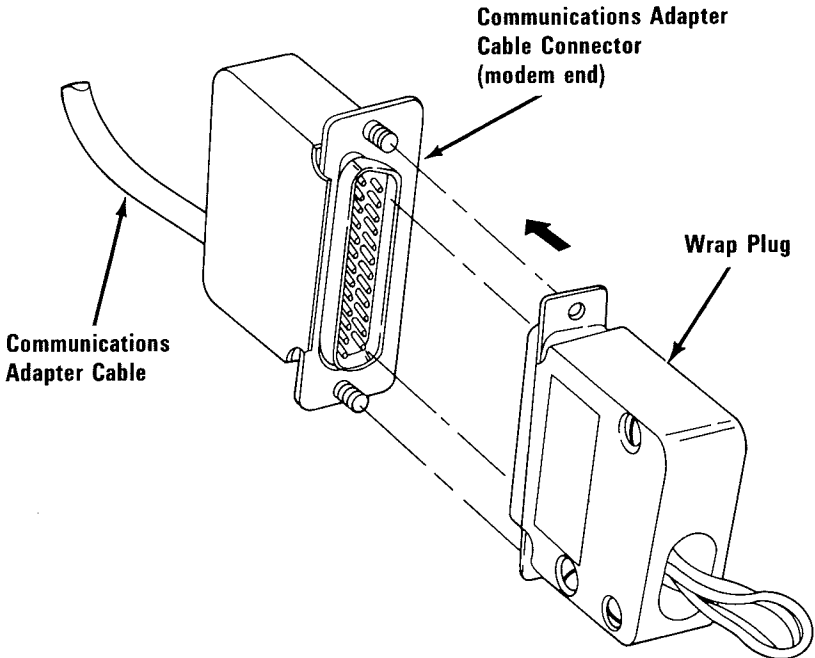

Note: If you do not have an IBM Cluster Adapter, continue with “Power-On Self Test (POST)” on the following page.

- 10** If you have an IBM Cluster Adapter, it came with a terminating plug. Disconnect the coaxial cable from the Cluster Adapter’s connector.
- 11** Refer to the figure below and install the terminating plug (IBM part number 6323481) on the Cluster Adapter’s connector.

Continue with “Power-On Self Test (POST)” on the following page.

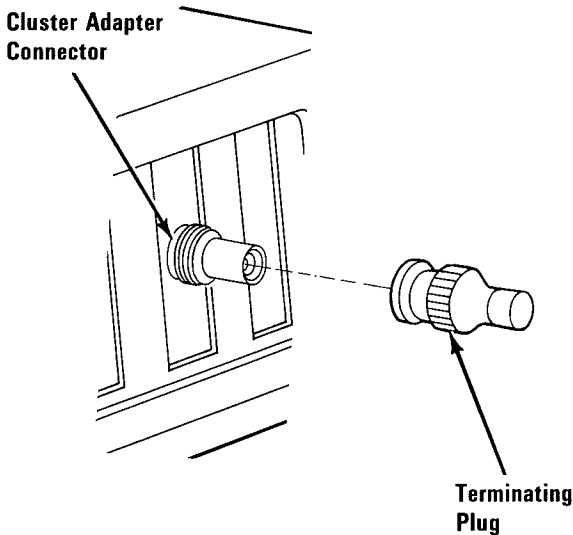

Power-On Self Test (POST)

- 1** Turn the Brightness and Contrast controls fully clockwise. When the first screen presentation appears, adjust the controls for eye comfort.

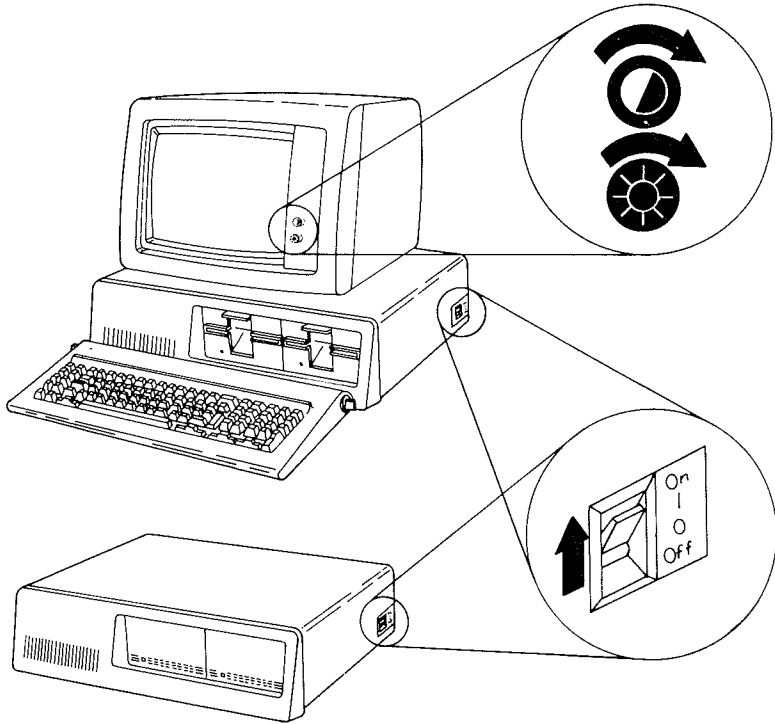

- 2** Set the Power switches on all attached devices to On.
- 3** If the expansion unit is attached, set its Power switch to On.
- 4** Set the system unit's Power switch to On.

POST will finish in 13 to 90 seconds, depending on the amount of memory in your system. Normally, you will receive the following responses:

- A Look in the upper left-hand corner of the screen during POST.

If you have the Personal Computer, a blinking cursor should appear.

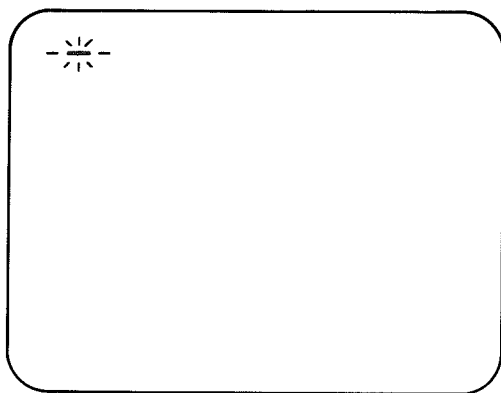

If you have the Personal Computer XT, a number should appear and continue to increase in value until it equals the amount of memory in your system.

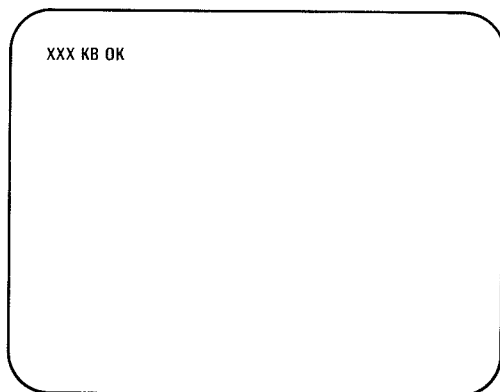

- B** One short beep will be heard when the test finishes successfully.
- C** The “IBM Personal Computer BASIC” message should appear. (If, at the end of POST, a program from a diskette, or an operating system from the fixed disk drive, is automatically loaded, the first screen presentation of the program or operating system should appear).

**The IBM Personal Computer Basic
Version CX.XX Copyright IBM Corp. XXXX
XXXXX Bytes free
Ok**

1LIST 2RUN 3LOAD 4SAVE 5CONT 6LPT1 7TRON 8TROFF 9KEY 0SCREEN

Did **A**, **B**, and **C** occur?

YES - Go to “Formatting a Diskette” on page Start 40-1.

NO - Personal Computer users go to “Personal Computer POST Errors” on the next page.

Personal Computer XT users go to “Personal Computer XT POST Errors” on Start 30-8.

Personal Computer POST Errors

In the following examples, find your screen response and audio response, then follow the instructions in the box marked "Action."

Warning: If the instructions are to have a unit serviced, and that unit has a fixed disk drive, we recommend that you back up all disk files onto diskettes. Normal shipping and handling can result in permanent loss of data on your fixed disk drives. Refer to the IBM *DOS* manual for a description of the Backup command.

Example 1

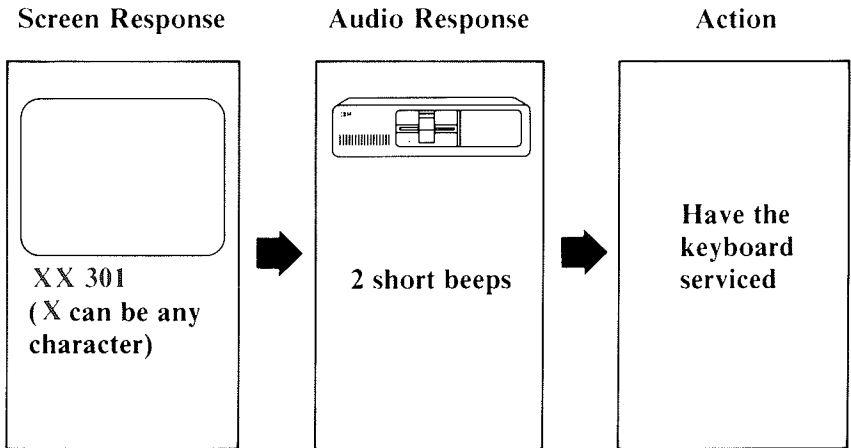

Note: Ensure the keyboard is connected correctly and check for any objects or foreign material on the keyboard. If error 301 still appears after the keyboard has been serviced, have the system unit serviced.

Example 2

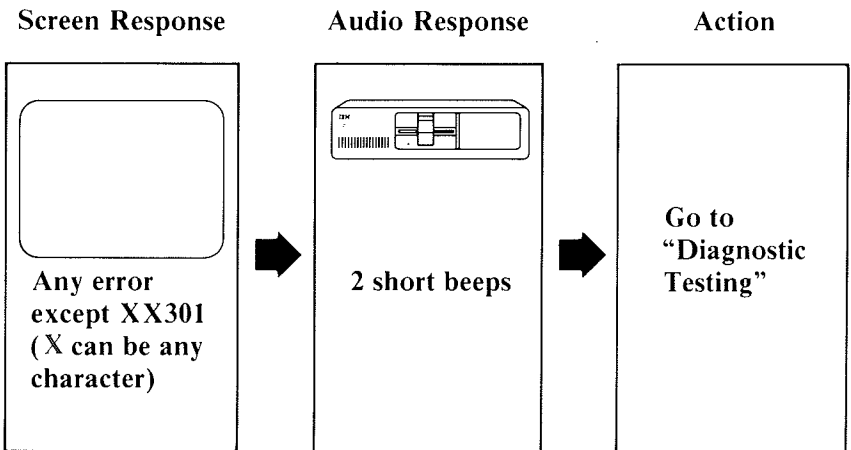

Example 3

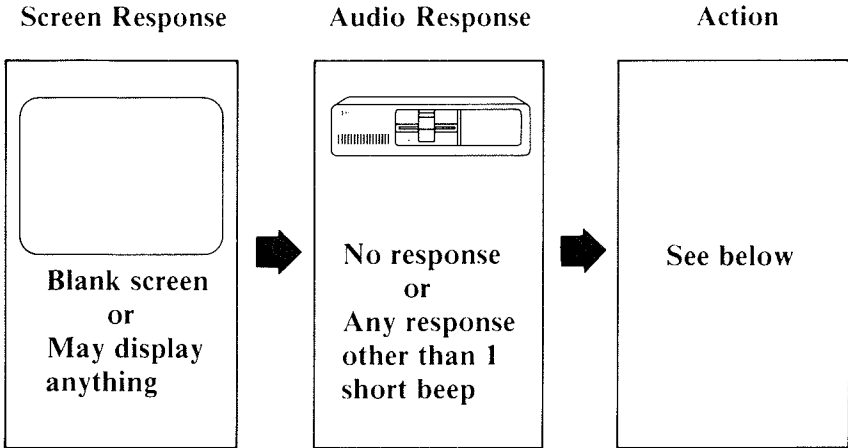

Do you have an expansion unit attached?

NO - Have the system unit serviced.

YES - Do the following:

1. Set the Power switches on the system unit and expansion unit to Off.
2. Set the Power switches on all attached devices to Off.
3. Disconnect the expansion unit cable from the system unit.
4. Set the Power switch on the system unit to On.

If the error is the same, have the system unit serviced.
If the error changes, have the expansion unit and its cable serviced.

Example 4 (Color Display Only)

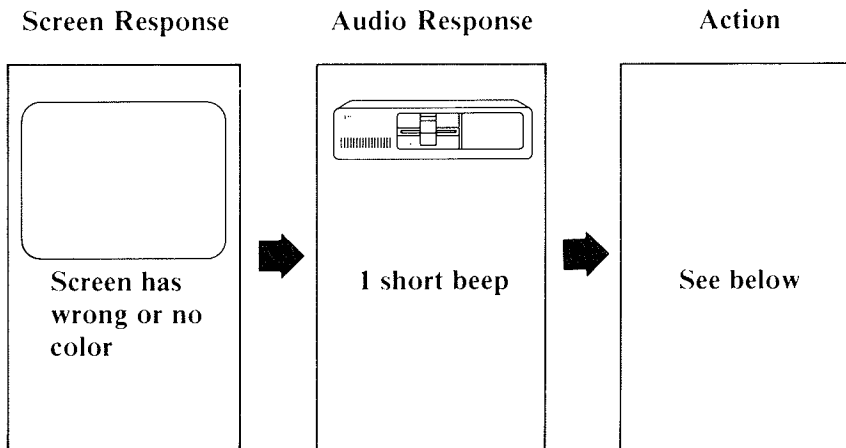

If you are using a TV as your display, verify that the color is correct by disconnecting your TV from the unit and operating the TV normally. Also, ensure your TV is compatible with the NTSC standard. If you have an IBM Color Display, go to Test 9000.

Example 5

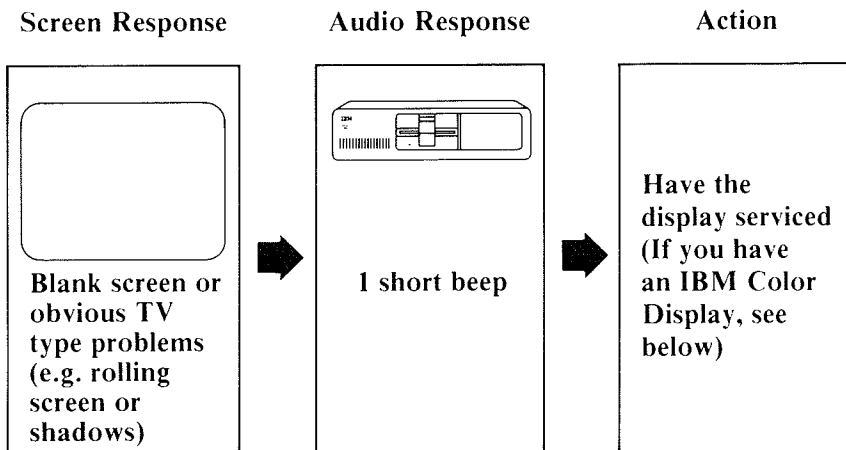

If you have an IBM Color Display, go to Test 9000.

Personal Computer XT POST Errors

In the following examples, find your screen response and audio response, then follow the instructions in the box marked "Action."

Warning: If the instructions are to have a unit serviced, and that unit has a fixed disk drive, we recommend that you back up all disk files onto diskettes. Normal shipping and handling can result in permanent loss of data on your fixed disk drives. Refer to the IBM *DOS* manual for a description of the Backup command.

Example 1

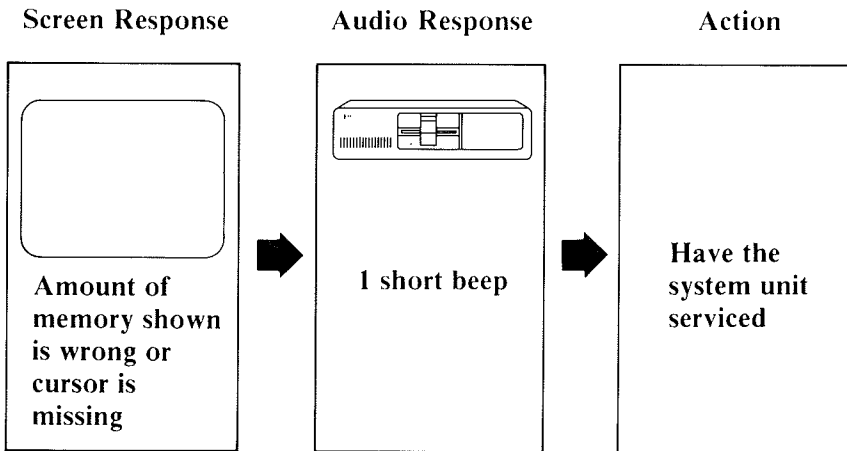

Example 2

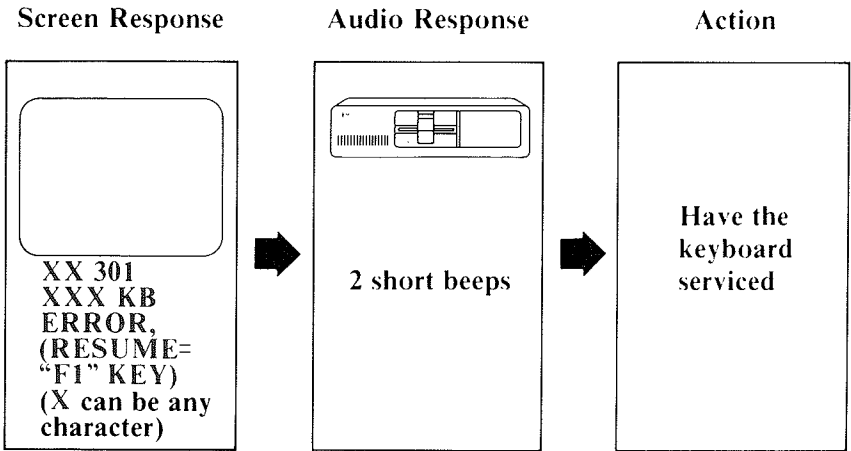

Note: Ensure the keyboard is connected correctly and check for any objects or foreign material on the keyboard. If error 301 still appears after the keyboard has been serviced, have the system unit serviced.

Example 3

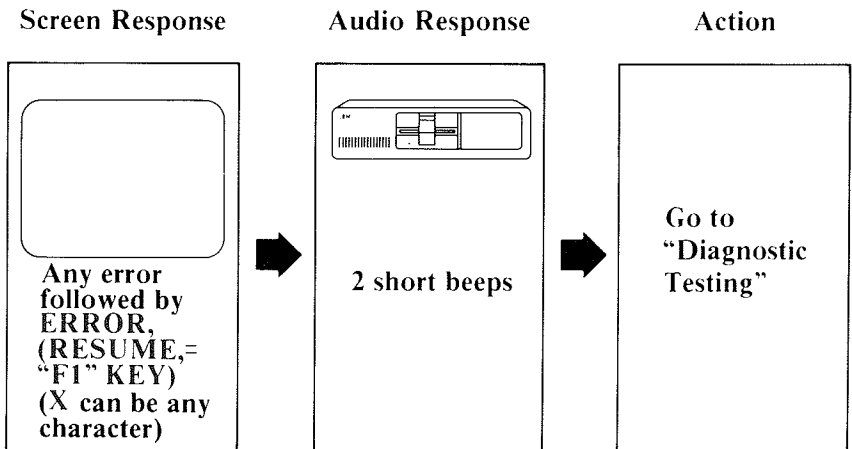

Example 4

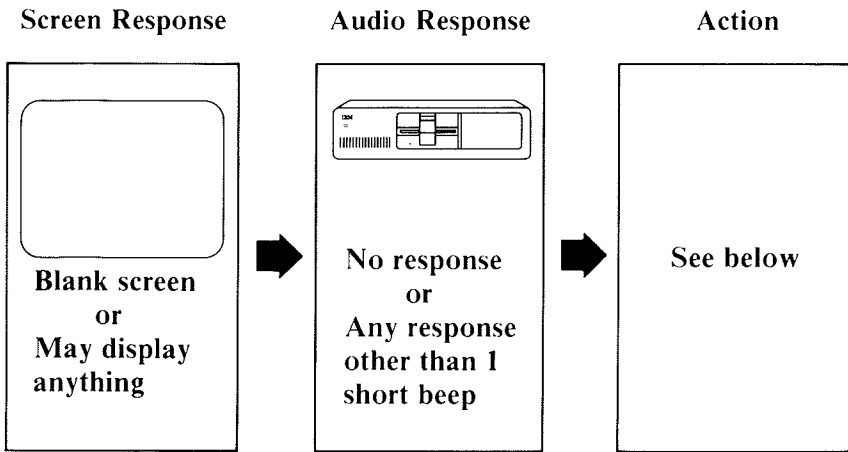

Do you have an expansion unit attached?

NO - Have the system unit serviced.

YES - Do the following:

1. Set the Power switches on the system unit and expansion unit to Off.
2. Set the Power switches on all attached devices to Off.
3. Disconnect the expansion-unit cable from the system unit.
4. Set the Power switch on the system unit to On.

If the error is the same, have the system unit serviced.
If the error changes, have the expansion unit and its cable serviced.

Example 5 (Color Display Only)

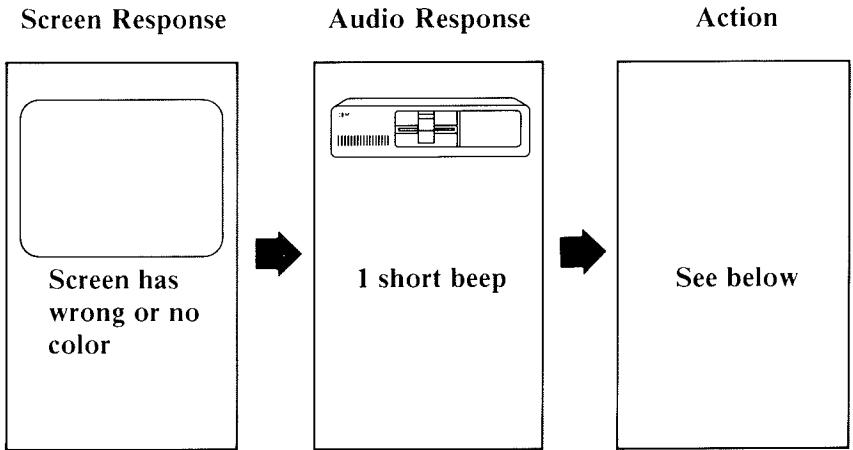

If you are using a TV as your display, verify that the color is correct by disconnecting your TV from the unit and operating the TV normally. Also, ensure your TV is compatible with NTSC standard. If you have an IBM Color Display, go to Test 9000.

Example 6

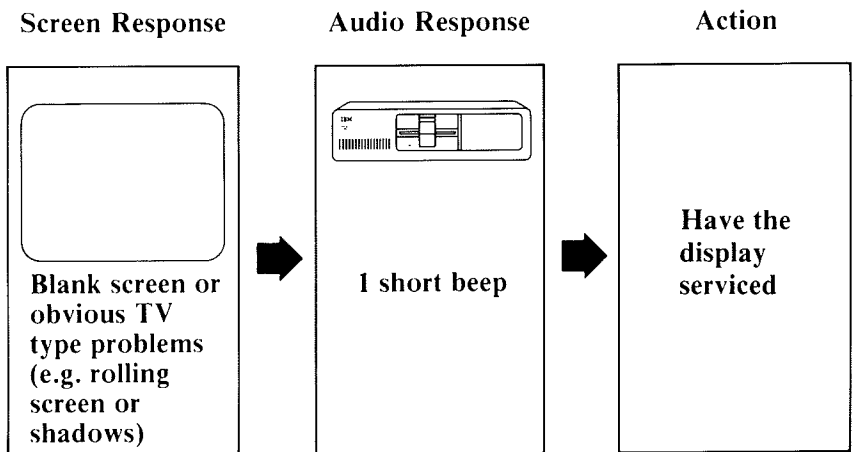

If you have an IBM Color Display, go to Test 9000.

Notes:

Formatting a Diskette

During the diagnostic tests that follow, you will need a scratch diskette (a *scratch* diskette is a formatted diskette with no data on it). If you already have a scratch diskette, skip this section and proceed to Diagnostic Testing on page Test 000-1. If you do not have a scratch diskette, continue with this procedure.

- 1** Remove the Diagnostics diskette from the back of this manual.

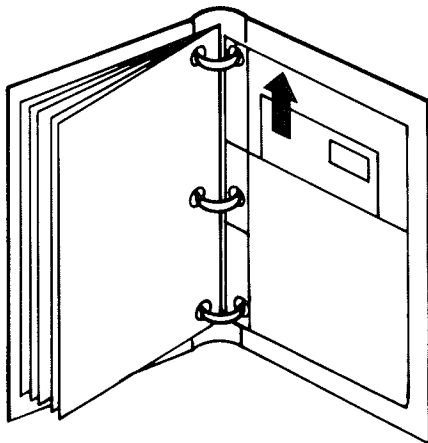

- 2** Set the Power switch on the system unit (and expansion unit, if attached) to Off.

- 3 Set the Power switches on all attached devices to Off.
- 4 Lift the diskette drive's load lever and insert the Diagnostics diskette into drive A.
- 5 Push the load lever down.

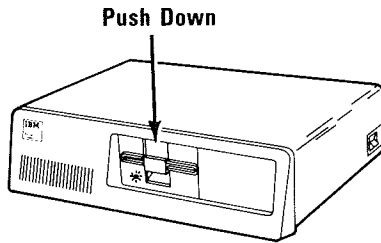

If you have trouble inserting your diskette, turn to the operating section of your *Guide to Operations* for more information.

- 6** Set the Power switches on all attached devices to On.
- 7** If an expansion unit is attached, set its Power switch to On.
- 8** Set the Power switch on the system unit to On.

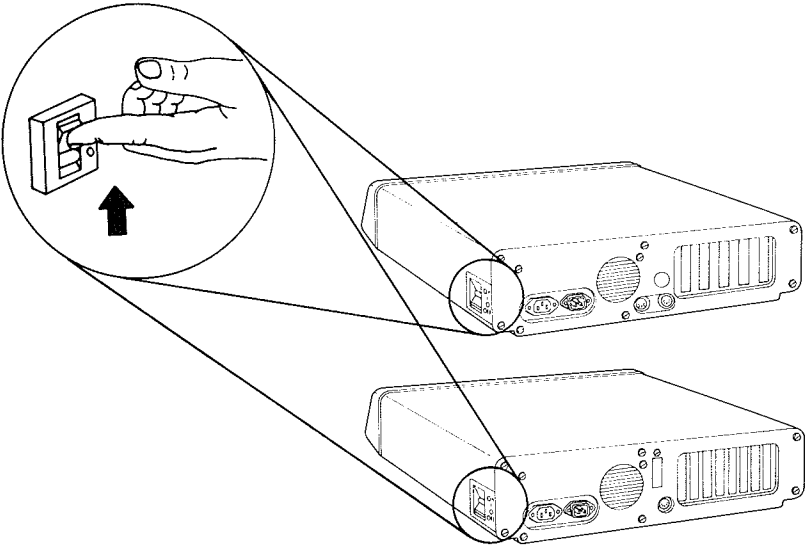

9 Did the following appear on your screen?

(X can be any character.)

XXXX
XXX KB OK
ERROR. (RESUME="F1" KEY)

YES - Press  , then go to the next step.

NO - Go to the next step.

10 Did the following appear on your screen?

**The IBM Personal Computer DIAGNOSTICS
Version XXX (C) Copyright IBM Corp XXXX, XXXX**

SELECT AN OPTION

0 - RUN DIAGNOSTIC ROUTINES

1 - FORMAT DISKETTE

2 - COPY DISKETTE

3 - PREPARE SYSTEM FOR RELOCATION

9 - EXIT TO SYSTEM DISKETTE

ENTER THE ACTION DESIRED

?

YES - Go to the next step.

NO - Remove the diskette and verify that it:

- Is the Diagnostics diskette.
- Was inserted correctly.

If the Diagnostics diskette was inserted correctly, have the system unit serviced.

11 Press  to select **FORMAT DISKETTE**,

then  .

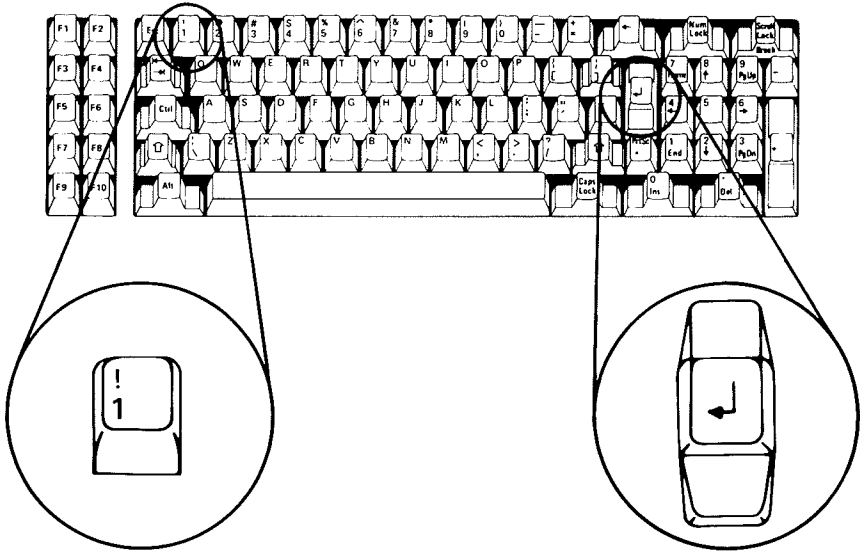

Go to the next step.

12 Did the following appear on your screen?

The IBM Personal Computer **DIAGNOSTICS**
Version XXX (C) Copyright IBM Corp XXXX, XXXX

SELECT AN OPTION

0 - RUN DIAGNOSTIC ROUTINES

1 - FORMAT DISKETTE

2 - COPY DISKETTE



3 - PREPARE SYSTEM FOR RELOCATION

9 - EXIT TO SYSTEM DISKETTE

ENTER THE ACTION DESIRED

? 1

**WHICH DRIVE CONTAINS DISKETTE
TO BE FORMATTED?**

YES - Press  then  and go to the
next step.

NO - Have your system unit serviced.

13 Did the following appear on your screen?

The IBM Personal Computer **DIAGNOSTICS**
Version XXX (C) Copyright IBM Corp XXXX
SELECT AN OPTION
0 - RUN DIAGNOSTIC ROUTINES
1 - FORMAT DISKETTE
2 - COPY DISKETTE
3 - PREPARE SYSTEM FOR RELOCATION
9 - EXIT TO SYSTEM DISKETTE
ENTER THE ACTION DESIRED
? 1
WHICH DRIVE CONTAINS DISKETTE
TO BE FORMATTED? A
INSERT DISKETTE TO BE FORMATTED
IN DRIVE A:
PRESS ENTER WHEN READY

YES - Remove the Diagnostics diskette from drive A, insert a blank diskette push the load lever down.

Press  and go to the next step.

NO - Have your system unit serviced.

14 The blank diskette will be formatted. When the In-Use light goes out, remove the scratch diskette and go to the next step.

- 15** Did the following appear on your screen after the diskette was formatted?

SELECT AN OPTION

0 - RUN DIAGNOSTIC ROUTINES

1 - FORMAT DISKETTE

2 - COPY DISKETTE

3 - PREPARE SYSTEM FOR RELOCATION

9 - EXIT TO SYSTEM DISKETTE

ENTER THE ACTION DESIRED

? - ✱ -

YES - Continue with “Diagnostic Testing” on page Test 000-1.

NO - Return to Step 10 and try another blank diskette. Be sure you insert the diskette correctly. If the problem still exists, have the system unit serviced.

Notes:

Diagnostic Testing

During the diagnostic tests that follow, you will need a scratch diskette. If you do not have a scratch diskette, go to "Diskette Format Procedure" on page Start 40-1.

During the diagnostic tests, you may be asked to record an error message. This information is needed when you have your system serviced.

Following are examples of error messages you may receive. **A message ending in 00 means the test finished successfully.**

In the examples, X can be any character.

Example 1

```
XX:XX:XX  
ERROR - SYSTEM UNIT  XXXX
```

Example 2

```
XX:XX:XX  
ERROR - EXPANSION UNIT  XXXX
```

The unit in which your options are installed determines if the error message reads **SYSTEM UNIT** or **EXPANSION UNIT**

Example 3

XX:XX:XX
XXX KB OK
ERROR. (RESUME="F1" KEY)

Warning: If the above message appears on your screen, it means the POST detected an error. The message also will appear if you have an expansion unit that is not connected to your system or that does not have its Power switch set to On.

Pressing the F1 key allows the system to bypass the error condition for the diagnostic tests, but your system may not function correctly unless it is serviced.

Continue with "Loading Diagnostics" on the next page.

Loading Diagnostics

- 1 Remove the Diagnostics diskette from the back of this manual.

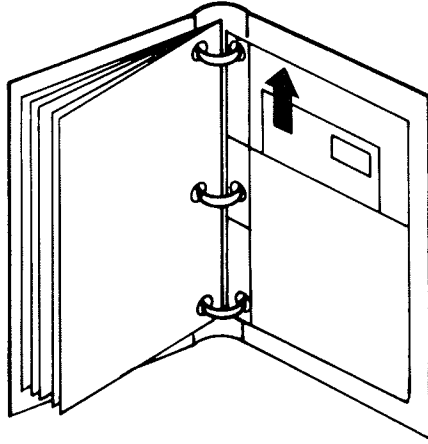

- 2 Set the Power switch on the system unit (and expansion unit, if attached) to Off.
- 3 Set the Power switches on all attached devices to Off.

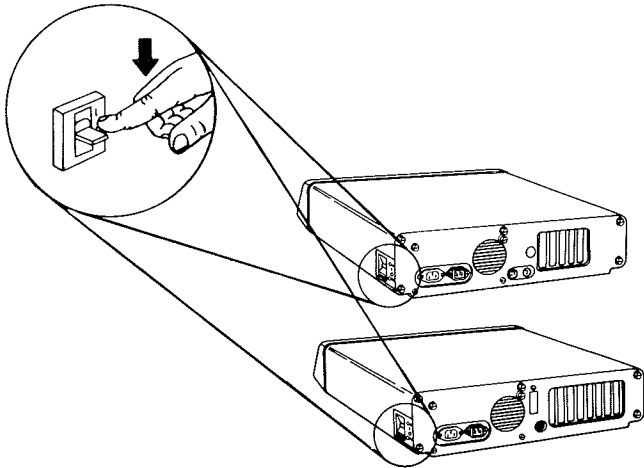

- 4** Raise the diskette drive's load lever and insert the Diagnostics diskette into drive A.
- 5** Push the load lever down.

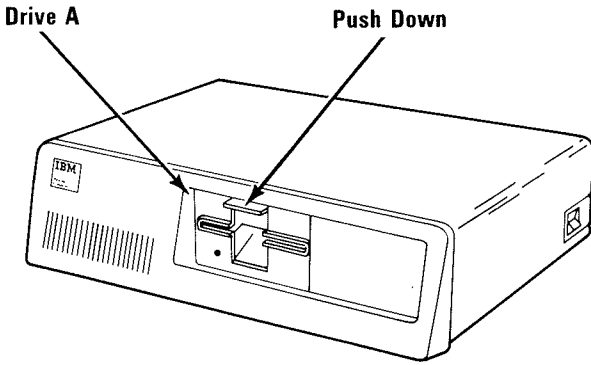

If you have trouble inserting your diskette, turn to the operating section of your *Guide to Operations* for more information.

- 6** Set the Power switches on all attached devices to On.
- 7** If an expansion unit is attached, set its Power switch to On.
- 8** Set the Power switch on the system unit to On.

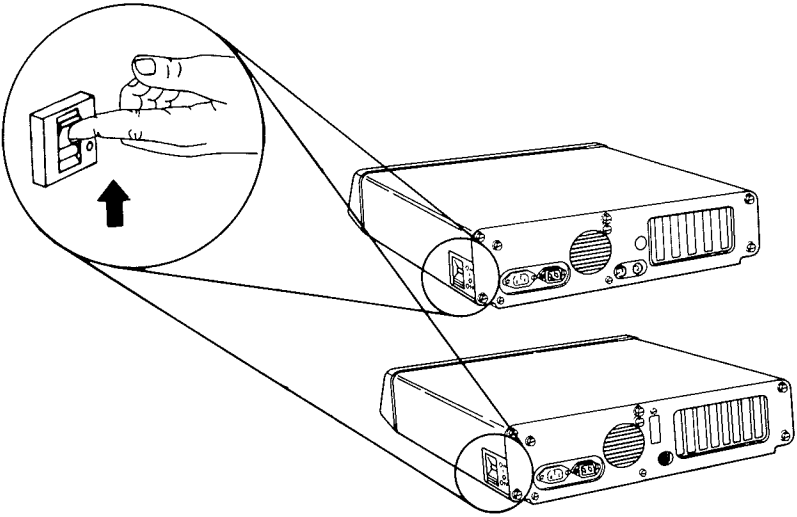

9

Did the following appear on your screen?

**XXXX
XXX KB OK
ERROR. (RESUME= "F1" KEY)**

YES - Press  , then go to the next step.

NO - Go to the next step.

10 Did the following appear on your screen?

The IBM Personal Computer DIAGNOSTICS
Version XXX (C) Copyright IBM Corp XXXX, XXXX
SELECT AN OPTION
0 - RUN DIAGNOSTIC ROUTINES
1 - FORMAT DISKETTE
2 - COPY DISKETTE
3 - PREPARE SYSTEM FOR RELOCATION
9 - EXIT TO SYSTEM DISKETTE
ENTER THE ACTION DESIRED
?



YES - Go to the next step.

NO - Remove the diskette and verify that it:

- Is the Diagnostics diskette.
- Was inserted correctly.

If the Diagnostics diskette was inserted correctly, have the system unit serviced.

Note: If you are using your TV or a non-IBM display, you could experience data errors when you operate your diskette drive. To correct this problem, move your TV or display a minimum of 30 cm (12 in.) away from your system unit.

11 Press , then  to select

RUN DIAGNOSTIC ROUTINES.

The IBM Personal Computer **DIAGNOSTICS**
Version XXX (C) Copyright IBM Corp XXXX



SELECT AN OPTION

- 0 - RUN DIAGNOSTIC ROUTINES**
- 1 - FORMAT DISKETTE**
- 2 - COPY DISKETTE**
- 3 - PREPARE SYSTEM FOR RELOCATION**
- 9 - EXIT TO SYSTEM DISKETTE**

ENTER THE ACTION DESIRED

?

Note: Depending on the configuration of your system, questions about attached devices may appear on your screen.

Press  or  as required,

then press .

- 12** Complete the list of installed devices and options and show their locations with check marks. Also enter the amount of memory you have in your system. Then go to the next step.

System Unit	Expansion Unit	Installed Device/Option
		System Board
		Expansion Option
		XXX KB of Memory
		Keyboard
		Monochrome and Printer Adapter
		X Diskette Drive(s) and Adapter
		Math Coprocessor
		X Fixed Disk Drive(s) and Adapter
		Asynchronous Communications Adapter

Installed Devices, Options, and Memory

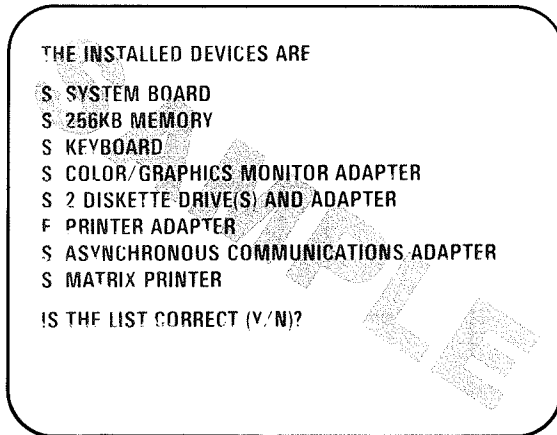

In the following sample, **S** means the device or option is installed in the system unit, and **E** means it is installed in the expansion unit.

- 13** Does the screen presentation correctly list all the installed devices and options?

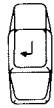

Note: The IBM Communications Cable and the Printer Cable will not appear in the list, and the Graphics Printer will be listed as "Matrix Printer." The Game Control Adapter may not be listed if the joysticks or paddles are not connected when the Power switch is set to On.

YES - Press  then  and go to the next step.

NO - Press  then , and record the error message. If your printer was not listed, press  and go to the next step. If any other device or option was not listed, have the unit that contains that option serviced.

14 Press  to select **RUN TESTS ONE TIME**,

then  .

SYSTEM CHECKOUT

- 0 - RUN TESTS ONE TIME**
- 1 - RUN TESTS MULTIPLE TIMES**
- 2 - LOG UTILITIES**
- 9 - EXIT DIAGNOSTIC ROUTINES**

ENTER THE ACTION DESIRED

?

The diagnostic programs have successfully loaded. Continue with the tests on the following pages to perform a complete system checkout.

Notes:

Test 100

Did you receive a **SYSTEM UNIT 100** message, as shown below?

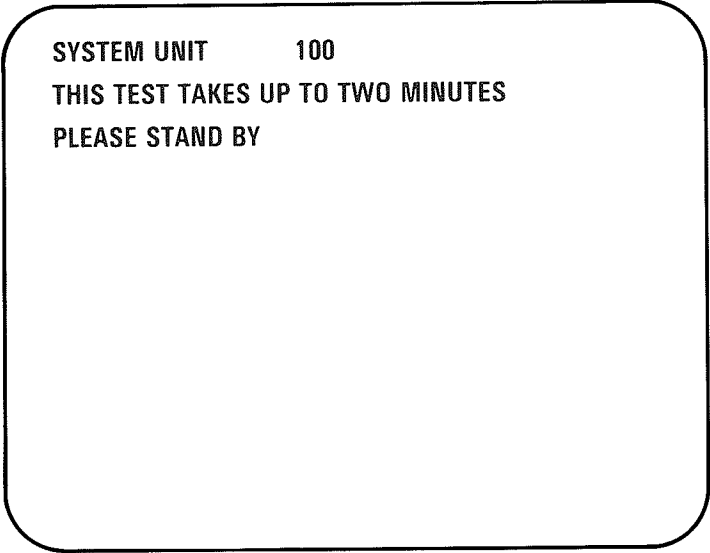

SYSTEM UNIT 100
THIS TEST TAKES UP TO TWO MINUTES
PLEASE STAND BY

YES - Your system has completed this test successfully. Continue with the next Test.

NO - Have the system unit serviced.

Notes:

Test 200

1 Do you have an IBM Expansion Unit attached to your system?

NO - Continue with the next Test, Test 300.

YES - Did you receive an **SYSTEM UNIT 1800** message, as shown below?

SYSTEM UNIT 100
SYSTEM UNIT 1800

THIS TEST TAKES UP TO TWO MINUTES
PLEASE STAND BY

YES - Your system has completed this test successfully. Continue with the next test, Test 300.

NO - Go to the next step.

- 2** Did you receive an **1819** error message, as shown below?

```
SYSTEM UNIT      100  
  
XX:XX:XX  
ERROR EXPANSION UNIT      1819  
  
PRESS ENTER TO CONTINUE  
?
```

YES - Have the expansion unit and its cable serviced.

NO - Go to the next step.

3

Did you receive an **1820** or **1821** error message?

SYSTEM UNIT 100

XX:XX:XX
ERROR EXPANSION UNIT 182X

PRESS ENTER TO CONTINUE
?

YES - Have the expansion unit and its cable serviced.

NO - Do the following:

1. Set the Power switches on the system unit and expansion unit to Off.
2. Set the Power switches on all attached devices to Off.
3. Disconnect the expansion-unit cable from the system unit.
4. Set the Power switch on the system unit to On.
5. Go to the next step.

- 4** When the POST finished, did the following appear on your screen?

1801

XXX KB OK

ERROR. (RESUME = "F1" KEY)

YES - Press  and go to the next step.

NO - Go to the next step.

5

Press , then



to select

RUN DIAGNOSTIC ROUTINES.

**The IBM Personal Computer DIAGNOSTICS
Version XXX (C) Copyright IBM Corp XXXX**



SELECT AN OPTION

- 0 - RUN DIAGNOSTIC ROUTINES**
- 1 - FORMAT DISKETTE**
- 2 - COPY DISKETTE**
- 3 - PREPARE SYSTEM FOR RELOCATION**
- 9 - EXIT TO SYSTEM DISKETTE**

ENTER THE ACTION DESIRED

? -  -

Note: Depending on the configuration of your system, questions about attached devices may appear on your screen.

Press  or  as required,

then press .



- 6** Are any of the options or devices installed in your expansion unit missing from the list?

THE INSTALLED DEVICES ARE

- S SYSTEM BOARD**
- S 256KB MEMORY**
- S KEYBOARD**
- S COLOR/GRAPHICS MONITOR ADAPTER**
- S 2 DISKETTE DRIVE(S) AND ADAPTER**
- E PRINTER ADAPTER**
- S ASYNCHRONOUS COMMUNICATIONS ADAPTER**
- S MATRIX PRINTER**

IS THE LIST CORRECT (Y/N)?

Note: The IBM Communications Cable and the Printer Cable will not appear in the list, and the Graphics Printer will be listed as "Matrix Printer." The Game Control Adapter may not be listed if the joysticks or paddles are not connected when the Power switch is set to On.

YES - Press  then  and go to the next step.

NO - Have the system unit serviced.

7

Press  to select

RUN TESTS ONE TIME, then .

SYSTEM CHECKOUT

0 - RUN TESTS ONE TIME

1 - RUN TESTS MULTIPLE TIMES

2 - LOG UTILITIES

9 - EXIT DIAGNOSTIC ROUTINES

ENTER THE ACTION DESIRED

?

Did you get an **1820** error message?

YES - Have the expansion unit and its cable serviced.

NO - Have the system unit serviced.



Notes:

Test 300

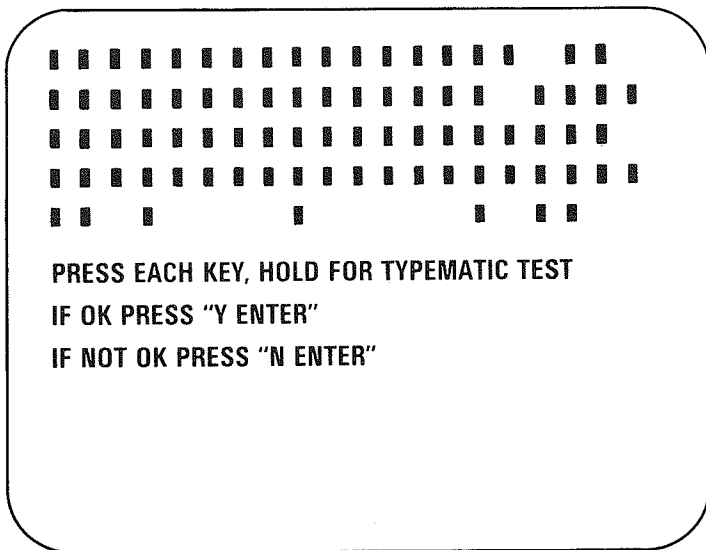
- 1** After approximately 2 minutes, did the following appear on your screen?



YES - Press each key once, then go to the next step.

NO - Press  then  . Record the

error message. Have the system unit serviced.

- 2 Did all the blocks change to characters as shown below?

1	2	←	1	2	3	4	5	6	7	8	9	Ø	-	=	↔	N	S		
3	4	⌞	Q	W	E	R	T	Y	U	I	O	P	[]		7	8	9	-
5	6	C	A	S	D	F	G	H	J	K	L	;	'	`	R	4	5	6	
7	8	S	\	Z	X	C	V	B	N	M	,	.	/	S	*	1	2	3	+
9	0	A						S						C	Ø	.			

**PRESS EACH KEY HOLD FOR TYPEMATIC TEST
IF OK PRESS "Y ENTER"
IF NOT OK PRESS "N ENTER"**

YES - Press and hold any key. The corresponding character on the screen will blink. This is the typematic test.

If the typematic test works correctly,

press  then  and go to the

next test. If the typematic test fails,

press  then . Record the

error message. Have the keyboard serviced.

NO - Have the keyboard serviced.

Test 400

1 Do you have an IBM Monochrome Display and Printer Adapter installed in your system?

NO - Continue with the next Test.

YES - Did the following appear on your screen?



```
XX:XX:XX  
ERROR SYSTEM UNIT 4XX
```

NO - Continue with the next step.

YES - Record the error message and have the unit that contains the adapter serviced.

2 Do you have an IBM Monochrome Display attached to the IBM Monochrome Display and Printer Adapter installed in your system?

NO - Continue with the next Test.

YES - Did the following appear on your screen?

DISPLAY ATTRIBUTES

THIS LINE IS AT NORMAL INTENSITY.



THIS LINE IS INTENSIFIED.



THIS LINE IS IN REVERSE VIDEO.

THIS LINE IS BLINKING

THIS LINE IS UNDERLINED

IS THE SCREEN CORRECT? (Y/N)

YES - Press  then  and go to the next step.

NO - Press  then  . Record the error message and have the unit that contains the adapter serviced.



80X25 DISPLAY



```

!"###%&'()*+,-./0123456789:;<=>?@ABCDEFGHIJKLMN
!"###%&'()*+,-./0123456789:;<=>?@ABCDEFGHIJKLMNC
!"###%&'()*+,-./0123456789:;<=>?@ABCDEFGHIJKLMNOF
#%&'()*+,-./0123456789:;<=>?@ABCDEFGHIJKLMNOC
#%&'()*+,-./0123456789:;<=>?@ABCDEFGHIJKLMNOCF
%&'()*+,-./0123456789:;<=>?@ABCDEFGHIJKLMNOCRE
%&'()*+,-./0123456789:;<=>?@ABCDEFGHIJKLMNOCRE
&'()*+,-./0123456789:;<=>?@ABCDEFGHIJKLMNOCRST
&'()*+,-./0123456789:;<=>?@ABCDEFGHIJKLMNOCRSTU
()*+,-./0123456789:;<=>?@ABCDEFGHIJKLMNOCRSTUV
()*+,-./0123456789:;<=>?@ABCDEFGHIJKLMNOCRSTUVV
*+,-./0123456789:;<=>?@ABCDEFGHIJKLMNOCRSTUVW>
+,-./0123456789:;<=>?@ABCDEFGHIJKLMNOCRSTUVWXY
+,-./0123456789:;<=>?@ABCDEFGHIJKLMNOCRSTUVWXYZ
-./0123456789:;<=>?@ABCDEFGHIJKLMNOCRSTUVWXYZI
./0123456789:;<=>?@ABCDEFGHIJKLMNOCRSTUVWXYZI\
/0123456789:;<=>?@ABCDEFGHIJKLMNOCRSTUVWXYZI\

```

IS THE SCREEN CORRECT? (Y/N)

YES - Press  then . Your system
has completed this test successfully.
Continue with the next Test.

NO - Press  then . Record the
error message and have the unit that
contains the adapter serviced.

Test 500

1 Do you have a color display or TV attached to your system?

NO - Continue with the next Test.

YES - Did the following appear on your screen?

DISPLAY ATTRIBUTES

THIS LINE IS AT NORMAL INTENSITY.

THIS LINE IS INTENSIFIED.

THIS LINE IS IN REVERSE VIDEO.

THIS LINE IS BLINKING.



BLUE



GREEN



CYAN



RED



MAGENTA







YELLOW



WHITE

IS THE SCREEN CORRECT ? (Y/N)



YES - Press  then  and go to the next step.



NO - Press  then . Record the error message and have the unit that contains the adapter serviced.

ADJ25 DISPLAY

```
! " # $ % & ' ( ) * + , - . / 0 1 2 3 4 5 6 7 8 9 : ; < = > ? @ A B C D E F
! " # $ % & ' ( ) * + , - . / 0 1 2 3 4 5 6 7 8 9 : ; < = > ? @ A B C D E F G
" # $ % & ' ( ) * + , - . / 0 1 2 3 4 5 6 7 8 9 : ; < = > ? @ A B C D E F G H
# $ % & ' ( ) * + , - . / 0 1 2 3 4 5 6 7 8 9 : ; < = > ? @ A B C D E F G H I
$ % & ' ( ) * + , - . / 0 1 2 3 4 5 6 7 8 9 : ; < = > ? @ A B C D E F G H I J
% & ' ( ) * + , - . / 0 1 2 3 4 5 6 7 8 9 : ; < = > ? @ A B C D E F G H I J K
& ' ( ) * + , - . / 0 1 2 3 4 5 6 7 8 9 : ; < = > ? @ A B C D E F G H I J K L
' ( ) * + , - . / 0 1 2 3 4 5 6 7 8 9 : ; < = > ? @ A B C D E F G H I J K L M
( ) * + , - . / 0 1 2 3 4 5 6 7 8 9 : ; < = > ? @ A B C D E F G H I J K L M N
) * + , - . / 0 1 2 3 4 5 6 7 8 9 : ; < = > ? @ A B C D E F G H I J K L M N O
* + , - . / 0 1 2 3 4 5 6 7 8 9 : ; < = > ? @ A B C D E F G H I J K L M N O P
+ , - . / 0 1 2 3 4 5 6 7 8 9 : ; < = > ? @ A B C D E F G H I J K L M N O P Q
, - . / 0 1 2 3 4 5 6 7 8 9 : ; < = > ? @ A B C D E F G H I J K L M N O P Q R
- . / 0 1 2 3 4 5 6 7 8 9 : ; < = > ? @ A B C D E F G H I J K L M N O P Q R S
```



IS THE SCREEN CORRECT? (Y/N)

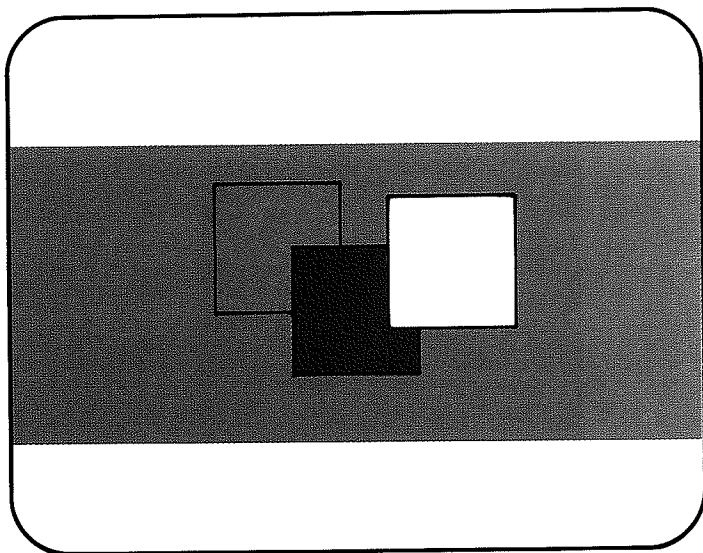

YES - Press  then  and go to the next step.

NO - Press  then  . Record the error message and have the unit that contains the adapter serviced.

5 Did the following appear on your screen, with the correct colors?





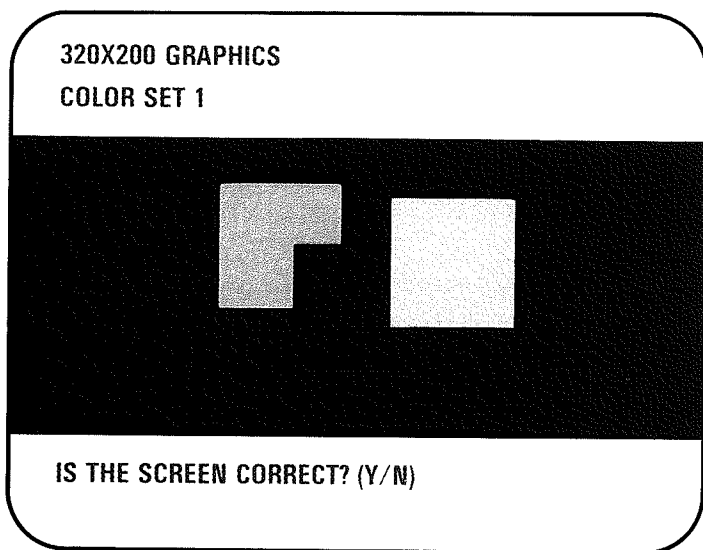

YES - Press  then  and go to the next step.

NO - Press  then . Record the error message and have the unit that contains the adapter serviced.

- 6 Did the following appear on your screen, with the correct colors?





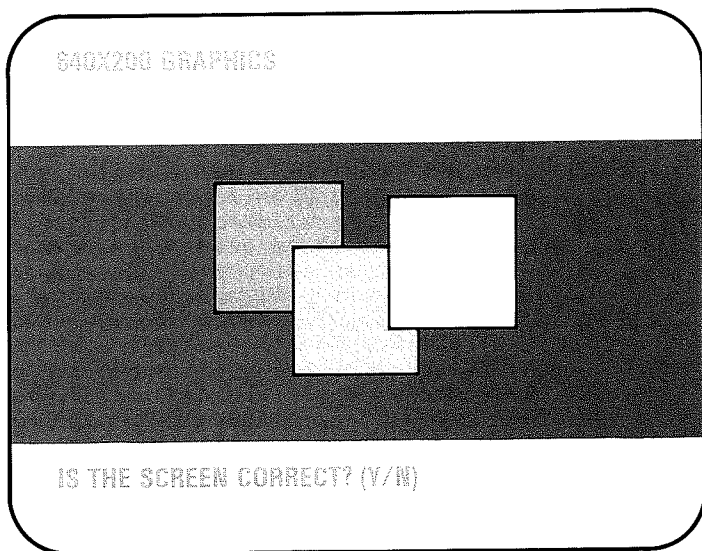

YES - Press  then  and go to the next step.

NO - Press  then . Record the error message and have the unit that contains the adapter serviced.

7 Did the following appear on your screen?



YES - Press  then  and go to the next step.

NO - Press  then  . Record the error message and have the unit that contains the adapter serviced.

Notes:

Test 600

- 1 Remove the Diagnostics diskette.
- 2 Does your screen match the one shown in the figure below?

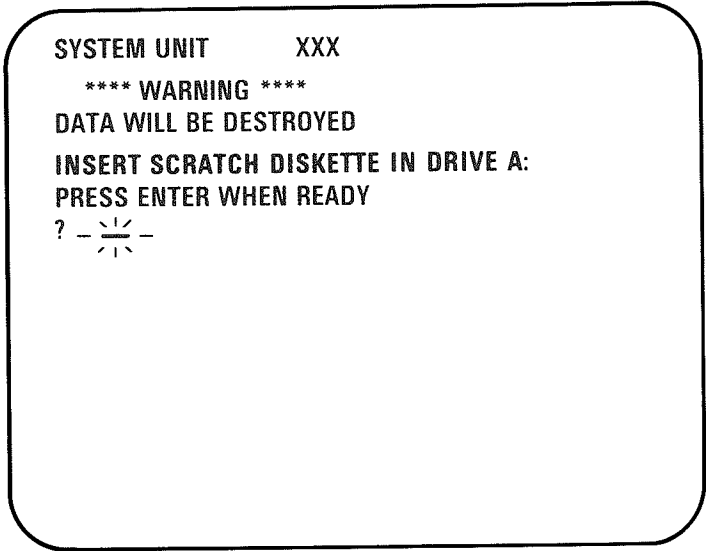



YES - Go to the next step.

NO - Record the error message and have the system unit serviced.

- 3** Insert a scratch diskette into drive A,
and press .

- 4** Did the following appear on your screen and is the drive type correct?

**DISKETTE DRIVE A: IS DOUBLE SIDED
IS THE DISKETTE DRIVE TYPE
CORRECT - (Y/N)?**

YES - Press  then . If you have

two diskette drives installed in your system, go to the next step. If you have only one diskette drive, your system has completed this test successfully. Continue with the next Test.

NO - Have the system unit serviced.

5 Did the following appear on your screen?

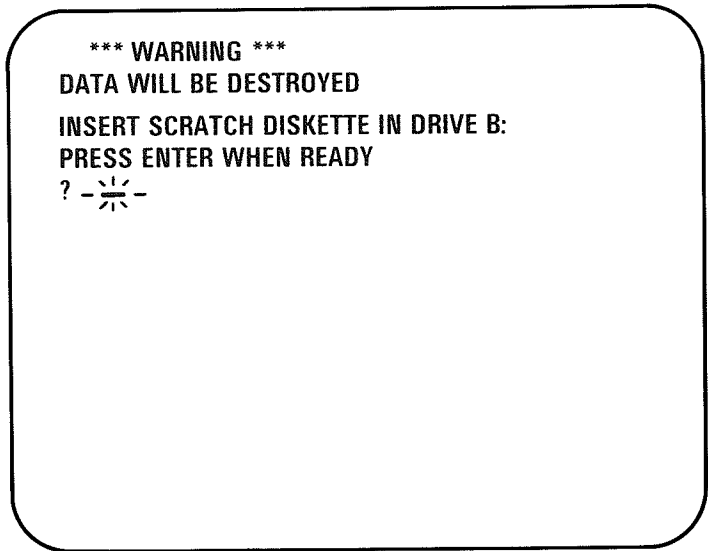



YES - Remove the scratch diskette from drive A, place it in drive B, and press  .
Go to the next step.

NO - Have the system unit serviced.

- 6** Did the following appear on your screen and is the drive type correct?

**DISKETTE DRIVE B: IS DOUBLE SIDED
IS THE DISKETTE DRIVE TYPE
CORRECT - (Y/N)?**

YES - Press  then  . Your system has completed this test successfully. Continue with the next Test.

NO - Have the system unit serviced.

Test 700

1 Do you have an IBM Math Coprocessor installed in your system?

NO - Continue with the next Test.

YES - Did the following appear and remain on your screen for more than 10 seconds?



SYSTEM UNIT 600

YES - Have the system unit serviced.

NO - Go to the next step.

2 Did the following appear on your screen?



XX:XX:XX
ERROR - SYSTEM UNIT 7XX

YES - Have the System unit serviced.

NO - Your system has completed this test successfully. Continue with the next Test.

Test 900

Do you have an IBM Printer Adapter installed in your system?

NO - Continue with the next Test.

YES - Did either of the following error messages appear on your screen?

XX:XX:XX
ERROR - SYSTEM UNIT 9XX

XX:XX:XX
ERROR EXPANSION UNIT 9XX

YES - Have the unit that contains the adapter serviced.

NO - Your system has completed this test successfully. Continue with the next Test.

Notes:

Test 1100

Do you have an IBM Asynchronous Communications Adapter installed in your system?

NO - Continue with the next Test.

YES - Did any of the following error messages appear on your screen?

XX:XX:XX	
ERROR - SYSTEM UNIT	11XX
XX:XX:XX	
ERROR - SYSTEM UNIT	12XX
XX:XX:XX	
ERROR EXPANSION UNIT	11XX
XX:XX:XX	
ERROR EXPANSION UNIT	12XX

YES - Have the unit that contains the adapter serviced.

NO - Your system has completed this test successfully. Continue with the next Test.

Notes:



Test 1300



1 Do you have an IBM Game Control Adapter installed in your system?



NO - Continue with the next Test.

YES - Did the following appear on your screen?



DO YOU HAVE JOYSTICKS, PADDLES,
OR NOTHING ATTACHED (J P N)?

YES - For joysticks press  then  and go to Step 2.

For paddles press  then  and go to Step 5.

For nothing press  then 
and continue with the next Test.

NO - Continue with the next Test.

2 Press  then .

3 Check for correct operation of your joysticks as follows:

1. Press each button and watch the word **RELEASED** change to **PRESSED**
2. Move each joystick and watch the character **A** or **B** move inside the box.

HOW MANY BUTTONS DO YOU HAVE (2/4)? 2

BUTTON A
RELEASED

* * *

* * *

* A *

* * *

* * *

BUTTON B
RELEASED

* * *

* * *

* B *

* * *



* * *

**PRESS AND RELEASE ALL BUTTONS,
EXERCISE ALL JOYSTICKS/PADDLES
AND PRESS ANY KEY WHEN DONE**

4 Did all buttons and joysticks operate correctly?

YES - Your system has completed this test successfully. Press any key and continue with the next Test.

NO - Have the joysticks and the unit in which the Game Control Adapter is installed serviced.

5 Press  or  for the number of paddles attached to your Game Control Adapter and press .

6 Press the same number for the number of buttons and press .

7 Check for correct operation of your paddles as follows:

1. Press each button and watch the word **RELEASED** change to **PRESSED**.
2. Turn each paddle control and check that **A**, **B**, **C**, or **D** moves inside the box.

```

HOW MANY BUTTONS DO YOU HAVE (2/4)?
BUTTON A   BUTTON B   BUTTON C   BUTTON D
RELEASED   RELEASED   RELEASED   RELEASED
*****
*   A   *           *   B   *
*****
*****
*   C   *           *   D   *
*****
  
```

**PRESS AND RELEASE ALL BUTTONS,
EXERCISE ALL JOYSTICKS/PADDLES
AND PRESS ANY KEY WHEN DONE**

Go to the next step.

8 Did all buttons and paddle controls operate correctly?

YES - Your system has completed this test successfully. Press any key and continue with the next Test.

NO - Have the paddles and the unit in which the Game Control Adapter is installed serviced.

Notes:

Test 1500

Do you have an IBM Synchronous Data Link Control Adapter installed in your system?

NO - Continue with the next Test.

YES - Did either of the following error messages appear on your screen?

XX:XX:XX
ERROR - SYSTEM UNIT 15XX

XX:XX:XX
ERROR EXPANSION UNIT 15XX

YES - Have the unit that contains the adapter serviced.

NO - Your system has completed this test successfully. Continue with the next Test.

Notes:





Test 1700

1 Do you have a fixed disk drive installed in one of your units?

NO - Continue with the next Test.

YES - The following appears on your screen.

*** WARNING ***
DATA ON CYLINDER 305 WILL BE
OVERWRITTEN BY FIXED DISK WRITE TESTS
DO YOU WANT TO INCLUDE FIXED DISK
WRITE TESTS ON DRIVE C: (Y/N) ?

Press  and then  if you want to include fixed-disk write tests, or  and then  if you do not.

Go to the next step.

This test can take up to 5 minutes.

2 Did the following appear on your screen?

Note: If you pressed N (no write test), **PERFORMING WRITE TEST** will not appear.

```
*** WARNING ***  
DATA ON CYLINDER 305 WILL BE  
OVERWRITTEN BY FIXED DISK WRITE TESTS  
  
DO YOU WANT TO INCLUDE FIXED DISK  
WRITE TESTS ON DRIVE C: (Y/N) ? y  
PERFORMING SEEK TEST  
PERFORMING WRITE TEST  
PERFORMING TRACK ZERO TEST  
PERFORMING SURFACE SCAN  
PLEASE STAND BY
```





YES - If you have one fixed disk drive, your system has successfully completed this test. Continue with the next Test. If you have two fixed disk drives, continue.

NO - Record the error message and have the unit that contains the fixed disk drive serviced.

3 Did the following appear on your screen?

***** WARNING ***
DATA ON CYLINDER 305 WILL BE
OVERWRITTEN BY FIXED DISK WRITE TESTS**

**DO YOU WANT TO INCLUDE FIXED DISK
WRITE TESTS ON DRIVE D: (Y/N) ?**

YES - Press  and then  if you
want to include fixed-disk write tests, or
 and then  if you do not.

Go to the next step.

NO - Record the error message and have the
expansion unit serviced.

4 Did the following appear on your screen?

Note: If you pressed N (no write test), **PERFORMING WRITE TEST** will not appear.

**DO YOU WANT TO INCLUDE FIXED DISK
WRITE TESTS ON DRIVE D: (Y/N) ? y
PERFORMING SEEK TEST
PERFORMING WRITE TEST
PERFORMING TRACK ZERO TEST
PERFORMING SURFACE SCAN
PLEASE STAND BY**

YES - Your system has successfully completed this test. Continue with the next Test.

NO - Record the error message and have the expansion unit serviced.

Test 2000

Do you have an IBM Binary Synchronous Communications Adapter installed in your system?

NO - Continue with the next Test.

YES - Did any of the following error messages appear on your screen?

XX:XX:XX
ERROR - SYSTEM UNIT 20XX

XX:XX:XX
ERROR - SYSTEM UNIT 21XX

XX:XX:XX
ERROR EXPANSION UNIT 20XX

XX:XX:XX
ERROR EXPANSION UNIT 21XX

YES - Have the unit that contains the adapter serviced.

NO - Your system has completed this test successfully. Continue with the next Test.

Notes:

Test 2200

1 Do you have an IBM Personal Computer Cluster Adapter installed in your system?

NO - Continue with the next Test.

YES - Did either of the following error messages appear on your screen?

**XX:XX:XX
ERROR-SYSTEM UNIT 22XX X**

**XX:XX:XX
ERROR-EXPANSION UNIT 22XX X**

YES - Have the unit that contains the adapter and the terminating plug serviced.

NO - Go to the next step.

- 2** Did either of the following error messages appear on your screen?

**TESTING – CLUSTER ADAPTER X
THE STATION ADDRESS IS XX
REMOTE IPL IS NOT SELECTED
XX:XX:XX
ERROR – SYSTEM UNIT 22XX
ERROR – EXPANSION UNIT 22XX
PRESS ENTER TO CONTINUE
?**

YES - Have the unit that contains the adapter and the terminating plug serviced.

NO - Go to the next step.

3 The following will appear on your screen.

Note: When more than one Cluster Adapter is installed in a Personal Computer, each of the adapters will be tested.

TESTING – CLUSTER ADAPTER X
THE STATION ADDRESS IS XX
REMOTE IPL IS NOT SELECTED

DO YOU WANT TO DISPLAY THE
CLUSTER STATUS (Y/N) ?

Go to the next step.

4 Does the adapter number, station address, and remote IPL information shown on your screen match the switch setting information you entered below?

Cluster Adapter Number _____

Station Address _____

Remote IPL (Is/Is Not) Selected _____

YES - Go to the next step.

NO - If the adapter number, station address, or remote IPL information is not correct, have the unit that contains the adapter serviced.



5

Do you want to display the cluster status?



Note: The cluster-status screen presentation will show 64 boxes that represent the stations in the cluster that have their Power switch set to On and are connected to the cluster bus.

**TESTING – CLUSTER ADAPTER X
THE STATION ADDRESS IS XX
REMOTE IPL IS NOT SELECTED
DO YOU WANT TO DISPLAY THE
CLUSTER STATUS (Y/N)?**

YES - Set the Power switch on all cluster system units (and expansion units, if installed) to On,

press  then , then go to the next step.

NO - Your system has successfully completed this test. Remove the terminating plug and attach the coaxial cable to the Cluster Adapter connector.

Press , then , and continue with the next Test.

6 The following will appear on your screen.

TESTING - CLUSTER ADAPTER X
THE STATION ADDRESS IS X
REMOTE IPL IS NOT SELECTED

DO YOU WANT TO DISPLAY THE
CLUSTER STATUS (Y/N) ? y

CONNECT THE CABLE TO THE
CLUSTER ADAPTER

PRESS ENTER WHEN READY
?

Disconnect the terminating plug and attach the
coaxial cable to the Cluster Adapter's connector.

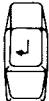
Press  and go to the next page.

This page explains the cluster status that may appear on your screen.

NN is any station address from 0 to 63.

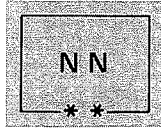

The system you are using is indicated on the screen in blinking reverse video, and the box is marked by two asterisks.

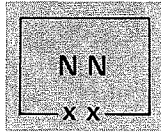

Stations that have their Power switch set to On are displayed in reverse video, and their boxes are marked by two Xs.

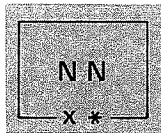

If another Personal Computer has the same station address as your Personal Computer, a long beep will sound every 3 seconds, the box will be displayed in blinking reverse video and will be marked by an X and an asterisk.

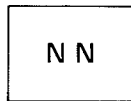

A station address not in the cluster is indicated by a box displayed in normal video and not marked with Xs or asterisks.

A Cluster-Access Error message may be displayed in reverse video.

Go to next step.

7

Wait 15 seconds. Do all stations in the cluster appear and remain on the screen presentation?

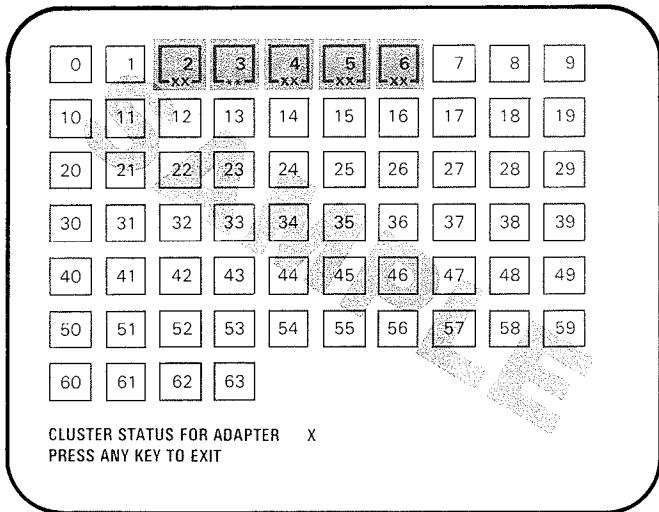

Notes:

1. Your installation manager has a cluster map that lists the station addresses and the order in which the stations are connected. Compare the map and the status screen presentation to determine that all stations in the cluster are operating properly.
2. The status screen shows all stations installed on your cluster, and is updated every 3 seconds to show stations that are added to or removed from the cluster.

YES - Your system has successfully completed this test. Press any key and continue with the next Test.

NO - Go to the next step.

8

Did a box appear in blinking reverse video with an X and asterisk, and did a beep sound every 3 seconds?

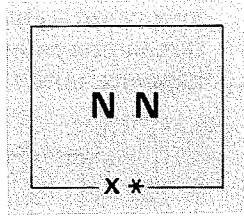

YES - Another Personal Computer has the same station address as your Personal Computer. Compare your cluster map with the status screen presentation. Do the system diagnostic tests on the Personal Computer missing from the cluster-status screen presentation.

Have the unit that contains the failing adapter serviced.

NO - Go to the next step.

9

Did a box appear in normal video with no Xs or asterisks, for a station address that is in the cluster?

Note: Multiple grounds on cluster cables may cause stations to appear on the status screen presentation intermittently. If this happens, notify your installation manager.

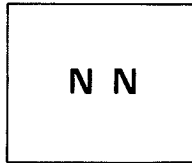

YES - Go to Step 11.

NO - Go to the next step.

10 Do you have a cluster-access error?

0	1	2	3	4	5	6	7	8	9
10	11	12	13	14	15	16	17	18	19
20	21	22	23	24	25	26	27	28	29
30	31	32	33	34	35	36	37	38	39
40	41	42	43	44	45	46	47	48	49
50	51	52	53	54	55	56	57	58	59
60	61	62	63						

CLUSTER ACCESS ERROR
PRESS ENTER TO CONTINUE

YES - Go to Step 11.

NO - Your system has successfully completed this test. Continue with the next Test.

11 You have stations that are not indicated on any status screen presentation, or by a cluster-access error message.

1. Do the system diagnostic tests on a station that is not indicated on any status screen presentation, or that has a cluster-access error.
2. If the diagnostic test fails, have the unit that contains the adapter serviced.
3. If the diagnostic test passes, continue doing the diagnostic tests until you test all of the stations that did not appear on any status screen presentation or that had a cluster-access error.
4. If the Cluster Adapters check good and the stations did not appear on the cluster-status screen presentations, notify your installation manager that you suspect the coaxial cable or a terminating plug.

Note: If you have more than one Cluster Adapter installed in your system, go back to page 2200-1 and continue until all Cluster Adapters are tested.

Test 7000

Do you have an IBM Printer attached to your system?

YES - Continue with the next Test.

NO - You have completed the Problem Determination Procedures with no failures. Remove the scratch diskette from your drive. Return the Diagnostics diskette to the back of this manual. Your system unit is ready to load your operating system.

If you should have any other problems, contact your place of purchase for additional help.

Notes:

Test 7010

1 Do you have an IBM Graphics/Matrix Printer attached to your system?

NO - Continue with the next Test.

YES - One of the following printer test patterns should print.

Matrix Printer Example

```
!"#$%&'()*+,-./
0123456789:;<=>?
@ABCDEFGHIJKLMNO
PQRSTUVWXYZ[\]^_
`abcdefghijklmno
pqrstuvwxyz{|}~
!"#$%&'()*+,-./
0123456789:;<=?
@ABCDEFGHIJKLMNO
PQRSTUVWXYZ[\]^_
`abcdefghijklmno
pqrstuvwxyz{|}~
!"#$%&'()*+,-./
" . 1 7 2 8 1 1 1 1
```

2 Did the printer test finish without any errors and the printer test pattern print correctly?

NO - Record the error message, and go to Test 8000.

YES - Continue with the next Test.

Notes:

Test 7020

1 Do you have an IBM PC Compact Printer attached to your system?

NO - Continue with the next Test.

YES - The following printer test pattern should print.

Compact Printer Example

```
!"#$%&'()*+,-./
0123456789:;<=>?
@ABCDEFGHIJKLMNO
PQRSTUVWXYZ[\]^_
!"#$%&'()*+,-./
0123456789:;<=>?
ABCDEFGHIJKLMNO

```

2 Did the printer test finish without any errors and the printer test pattern print correctly?

NO - Go to Test 8010.

YES - Continue with the next Test.

Notes:

Test 7030

1 Do you have an IBM Personal Computer Color Printer attached to your system?

NO - Continue with the next Test.

YES - Does your screen match the screen shown below?

SELECT PAPER WIDTH

1 - 8 1/2 INCH PAPER WIDTH
2 - 14 1/2 INCH PAPER WIDTH

ENTER THE OPTION DESIRED
?

NO - Go to Test 8020.

YES - Go to the next step.

2 Select the width of paper you are using.



SELECT PAPER WIDTH



1 - 8 1/2 INCH PAPER WIDTH

2 - 14 1/2 INCH PAPER WIDTH

ENTER THE OPTION DESIRED

?

Press  then  for paper
8-1/2 inches wide.

Press  then  for paper
14-1/2 inches wide.

Note: If the print example shows the incorrect character set, check the DIP switches. If the DIP switches are set correctly, have your printer serviced.



4 Did the printer test pattern finish without any errors and the printer test pattern print correctly?



YES - Go to the next step.

NO - If the test pattern is correct but the colors are wrong, go to the next step. If the test pattern is not correct or you received an error message, record the error message and go to Test 8020.

- 5** Are the characters in your test pattern correct and is each character only one color?

ARE THE CHARACTERS ON THE PRINTED
TEST PATTERN CORRECT, AND EACH
CHARACTER A SINGLE COLOR (Y/N)
?

YES - Press  then  and
go to Step 8.

NO - Press  then  and
continue on the next step.

Note: Refer to the “Ribbon-Color Knob Adjustment” procedure in the “IBM Personal Computer Color Printer Installation and Operating Instructions” in your *Guide to Operations*.

- 6** Perform the ribbon adjustment procedure. Then press  to print the test pattern and verify the adjustment.

Warning: Wait until the printer stops before making any adjustments.

- 7** Return to Step 4.

Note: If you are unable to adjust the ribbon, have the printer serviced.

- 8** Continue with the next Test.

Test 7900

You have completed the problem determination procedures. Remove the scratch diskette from your drive. Return the Diagnostics diskette to the back of this manual. Your system unit is now ready for you to load your operating system.

If you encounter any other problems, contact your place of purchase for additional help.

Notes:

Test 8000

1 Check your wall outlet for proper operation (use a working lamp).

2 Verify that the Printer Cable is properly connected to the printer and the system unit.

Did you find any problem while doing the above step?

NO - Go to the next step.

YES - Correct the problem and perform the system diagnostic tests again.

3 Set the Power switches on the printer and system unit to Off. (If an expansion unit is attached, also set its Power switch to Off.)

4 Disconnect the Printer Cable.

5

Perform the printer self-test:

1. Press and hold the Line Feed button while you set the printer's Power switch to On.
2. When the test starts, release the Line Feed button.

Note: The printer self-test takes approximately 10 minutes.

3. To stop the test before it finishes, set the printer's Power switch to Off.

Sample Printout for International Graphics Printer

?@A
; <=>?@AB
() * + , - . / 0 1 2 3 4 5 6 7 8 9 ; ; <=>?@ABC
\$ % & ' () * + , - . / 0 1 2 3 4 5 6 7 8 9 ; ; <=>?@ABCD
! " # \$ % & ' () * + , - . / 0 1 2 3 4 5 6 7 8 9 ; ; <=>?@ABCDE
! " # \$ % & ' () * + , - . / 0 1 2 3 4 5 6 7 8 9 ; ; <=>?@ABCDEF
! " # \$ % & ' () * + , - . / 0 1 2 3 4 5 6 7 8 9 ; ; <=>?@ABCDEFG
" # \$ % & ' () * + , - . / 0 1 2 3 4 5 6 7 8 9 ; ; <=>?@ABCDEFGH
\$ % & ' () * + , - . / 0 1 2 3 4 5 6 7 8 9 ; ; <=>?@ABCDEFGHI
\$ % & ' () * + , - . / 0 1 2 3 4 5 6 7 8 9 ; ; <=>?@ABCDEFGHI
% & ' () * + , - . / 0 1 2 3 4 5 6 7 8 9 ; ; <=>?@ABCDEFGHI
' () * + , - . / 0 1 2 3 4 5 6 7 8 9 ; ; <=>?@ABCDEFGHI
() * +

Did the self-test finish without failures?

YES - Go to Step 13.

NO - Go to the next step.

- 7 Ensure the ribbon is installed properly.
- 8 Ensure the forms or paper is inserted properly.
- 9 Ensure the forms or paper path has no obstructions.
- 10 Ensure the tractors are adjusted properly.

If you need help with any of the above, refer to the operating instructions that came with your printer.

- 11 Did you find any problem while doing the above steps?

NO - Go to the next step.

YES - Correct the problem and restart the printer self-test.

Note: If you are using a non-U.S. English keyboard and your printout does not match the desired character set, have your printer serviced.

12 Does your printer have any of the following problems?

- It beeps even though the paper is inserted properly.
- It does not beep even when out of paper.
- Some lights on the control panel do not work.
- Some buttons on the control panel do not work.
- The printer continues to print when out of paper.
- The printer fails to print or prints incorrectly.

NO - Go to Step 14.

YES - Have your printer serviced.

13 Did you receive any of the following error messages during diagnostic testing?

199

432

901

1401

YES - Go to the next step.

NO - If you are still having a problem, go to step 16.

14 Leave the Printer Cable disconnected from the printer and do the system diagnostic tests again. Verify that the list of installed devices and options is correct (your printer will be missing from the list).

15 Did you receive the same error message during the system diagnostic tests?

YES - If your printer is attached to an adapter in your system unit, have the system unit serviced. If your printer is attached to an adapter in the expansion unit, have the expansion unit serviced.

NO - Have the printer and cable serviced.

16 Your printer also is controlled by program commands from the system unit. If you still have a printer problem, or if the problem occurs only during a particular program, examine the program thoroughly for commands that might cause the printer to produce undesired results.

If you complete the printer self-test and have no apparent program problems, have the unit to which the printer is attached serviced.

Test 8010

1 Check your wall outlet for proper operation (use a working lamp).

2 Verify that the Printer Cable is properly connected to the printer and system unit.

Did you find any problem while doing the above step?

NO - Go to the next step.

YES - Correct the problem and perform the system diagnostic tests again.

3 Set the Power switches on the printer and system unit to Off. (If an expansion unit is attached, also set its Power switch to Off.)

4 Disconnect the Printer Cable.

5

Perform the printer self-test:

1. Be sure that nothing prevents the paper from moving.
2. Be sure the top cover is closed properly.
3. Press and hold down the Form Feed button while you set the printer's Power switch to On.
4. When the test starts, release the Form Feed button.

6

This test will run until you set the printer's Power switch is set to Off.

7

Below is a sample of the printout for the IBM PC Compact Printer. Compare your printout with the sample.

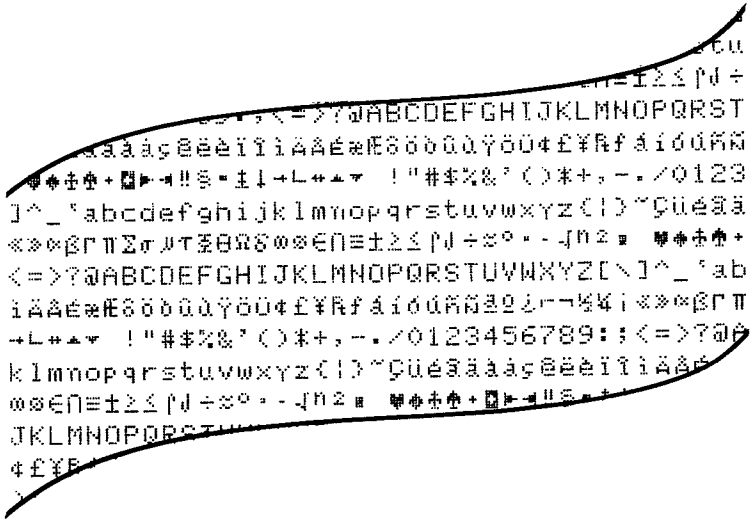

Did the self-test finish without failures?

YES - Go to Step 9.

NO - Go to the next step.

8 Does your printer have any of the following problems?

- Its Ready light blinks continuously.
- It prints reversed question marks continuously.
- It prints characters with extra or missing dots.
- It sounds as if it is operating but does not print. (Be sure the paper is inserted properly.)
- It does not do anything.

YES - Have your IBM PC Compact Printer serviced.

NO - Go to the next step.

9 Your printer also is controlled by program commands from the system unit. If you still have a printer problem, or a problem occurs only during a particular program, examine the program thoroughly for commands that might cause the printer to produce undesired results.

10 If you have completed the printer self-test and have no apparent program problems, have the unit to which the printer is attached serviced.

Test 8020

1 Check your wall outlet for proper operation (use a working lamp).

2 Verify that the Printer Cable is properly connected to the printer and system unit.

Did you find any problem while doing the above step?

NO - Go to the next step.

YES - Correct the problem and perform the system diagnostic tests again.

3 Set the Power switches on the printer and system unit to Off. (If an expansion unit is attached, also set its Power switch to Off.)

4 Disconnect the Printer Cable.

5

Perform the printer self-test:

1. Open the access cover and set all DIP switches to Off.
2. Close the access cover.
3. Set the printer's Power switch to On.
4. Press the Ready button to set the printer to the Not Ready state (Ready light is off).
5. Press the Test Mode button.
6. To stop the test, press the Test Mode button again.

- 7** Ensure the ribbon is installed properly.
- 8** Ensure your forms or paper is inserted properly.
- 9** Ensure the forms path or paper path has no obstructions.
- 10** Ensure the tractors are adjusted properly.

If you need help with any of the above, refer to the operating instructions that came with your printer.

Did you find any problem while doing the above steps?

NO - Go to the next step.

YES - Correct the problem and restart the printer self-test.

Note: If you are using a non-U.S. English keyboard and your printout does not match the desired character set, verify that the switch settings are correct for the desired character set. If the switch settings are correct, have your printer serviced.

11 Does your printer have any of the following problems?

- It beeps even though the paper is inserted properly.
- It does not beep even when out of paper.
- Some lights on the control panel do not work.
- Some buttons on the control panel do not work.
- The printer continues to print when out of paper.
- The printer fails to print or prints incorrectly.

NO - Go to Step 18.

YES - Go to the next step.

12 Ensure that all DIP switches are set to Off. (See the switch setting charts in your printer's installation and operating instructions.)

13 Ensure the Forms Thickness Control lever is properly adjusted.

14 Ensure the Feed Mode lever is in the correct position.

Did you find any problem while doing the above steps?

NO - Have your printer serviced.

YES - Correct the problem and restart the printer self-test.

15 If you receive any of the following error messages during diagnostic testing, continue with the next step:

199

432

901

1401

2901

2902

If you did not receive any of the error messages but still have a problem, go to Step 18.

16 Leave the Printer Cable disconnected from the printer and do the system diagnostic tests again. Verify that the list of installed devices and options is correct (your printer will be missing from the list).

17 Did you receive the same error message during the tests?

YES - If your printer was attached to an adapter in your system unit, have the system unit serviced. If your printer was attached to an adapter in the expansion unit, have the expansion unit serviced. Remember to reset the DIP switches.

NO - Have the printer and its cable serviced.

18 Your printer also is controlled by program commands from the system unit. If you are still having a printer problem, or if a problem occurs only during a particular program, examine the program thoroughly for commands that might cause the printer to produce undesired results.

If you have completed the printer self-test and have no apparent program problems, have the unit to which the printer is attached serviced.

Remember to reset the DIP switches.

Notes:

Test 9000

Note: If your IBM Color Display requires service, it must be returned with the power cord.

- 1** Set the Power control to On.

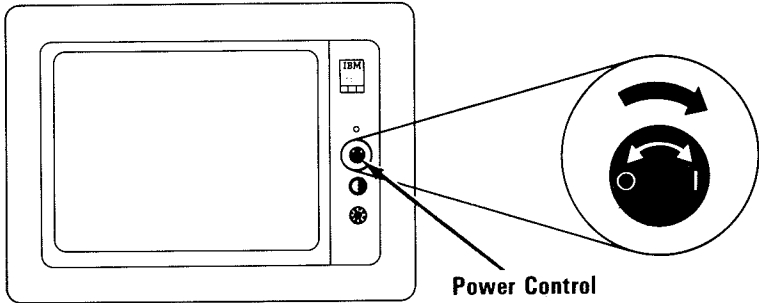

- 2** Is the Power-On indicator lit?

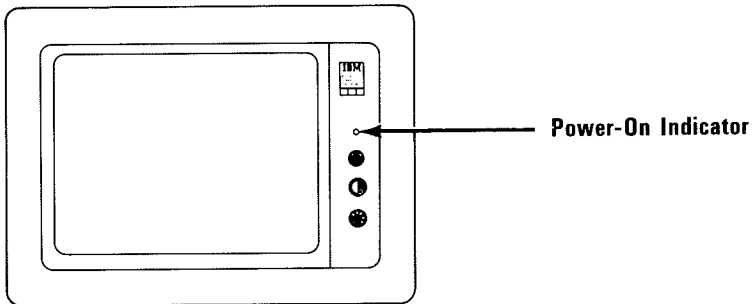

YES - Go to the next step.

NO - Check that the power cord is plugged into a functioning wall outlet and into the rear of the display. If it is, have the display serviced.

- 3 Set the Power switch on the system unit (and expansion unit, if attached) to Off.
- 4 Turn the Brightness and Contrast controls fully clockwise.

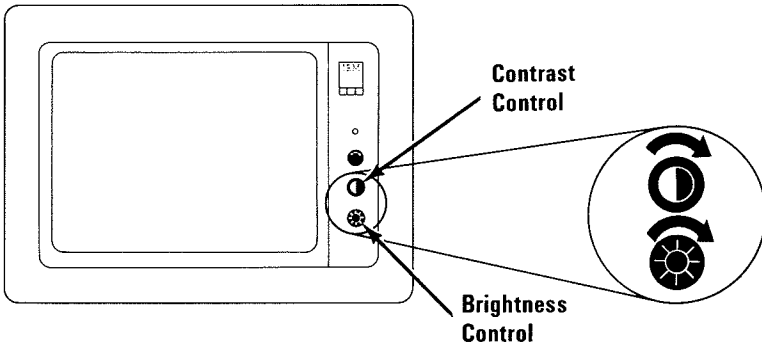

- 5 Turn the Vertical Size control fully counterclockwise. A black area should appear across the top and bottom of the screen.

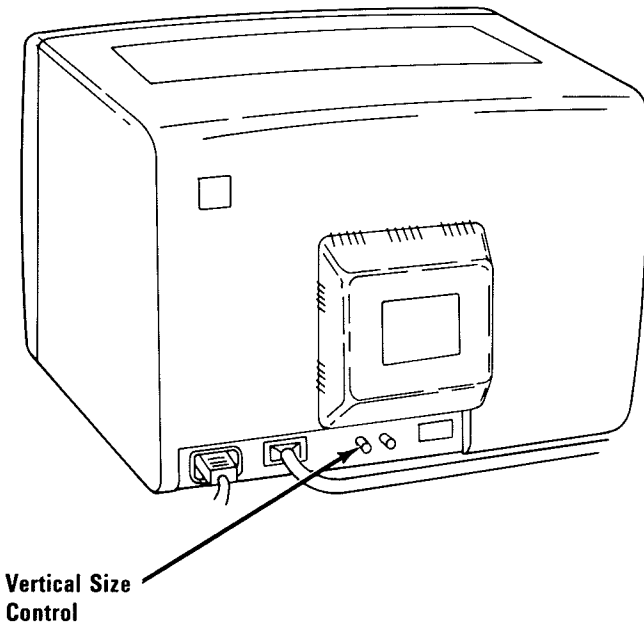

- 6** Does the black area appear across the top and bottom of the screen?

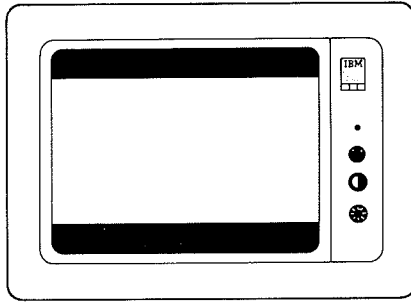

YES - Go to the next step.

NO - Have the display serviced.

- 7** Are the black areas approximately the same size?

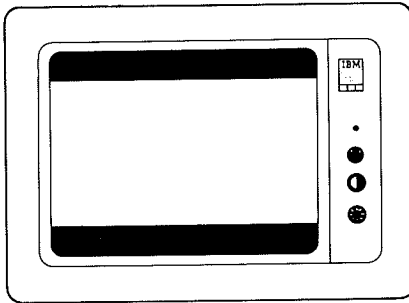

YES - Go to the next step.

NO - Have the display serviced.

- 8** Turn the Vertical Size control clockwise until the black areas just disappear. If one of the black areas disappears before the other, continue to turn the control until the second black area is gone.

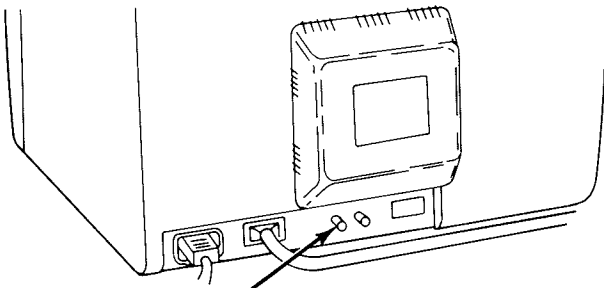

**Vertical Size
Control**

- 9** Is the entire screen white?

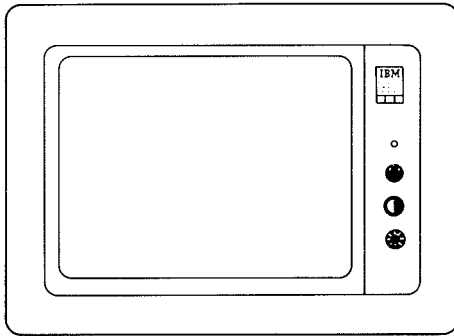

YES - Go to Step 14.

NO - Go to the next step.

- 10** Set the display's Power control to Off.
- 11** Disconnect the display's signal cable from the system unit (or expansion unit).

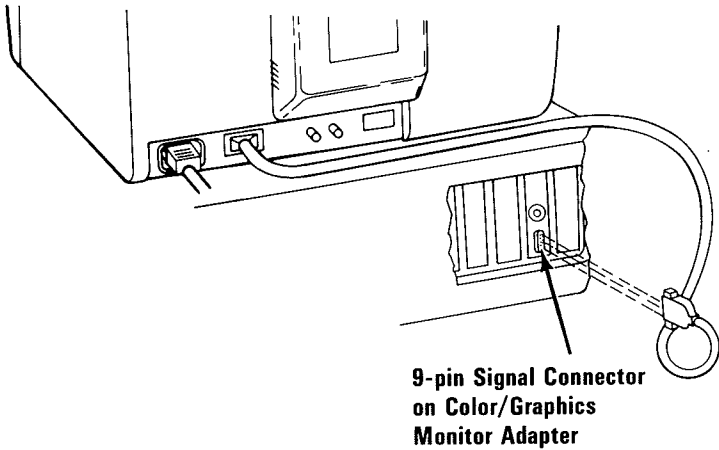

- 12** Set the display's Power control to On.
- 13** Is the screen white?
 - YES** - Have the unit to which the display was attached serviced.
 - NO** - Have the display serviced.
- 14** Watch the screen and set the Power switch on the expansion unit (if attached) to On. Then set the system unit's Power switch to On.

15 Did the screen change from white to black when the Power switch was set to On? (The screen may remain black for only 13 seconds before changing again.)

YES - Go to the next step.

NO - Have the display serviced.

16 Wait for the power-on self test (POST) to finish. The IBM Personal Computer BASIC message, with a blinking cursor, appears unless a diskette is inserted or an operating system is automatically loaded from a fixed disk drive.

The IBM Personal Computer Basic
Version CX.XX Copyright IBM Corp. XXXX
XXXXX Bytes free
Ok

1LIST 2RUN 3LOAD" 4SAVE" 5CONT 6LPT1 7TRON 8TROFF 9KEY 0SCREEN

17 Is your screen blank?

NO - Go to the next step.

YES - Have the unit to which the display was attached serviced.

18 Is the screen presentation steady?

YES - Go to Step 21.

NO - Go to the next step.

19 Turn the Vertical Hold control clockwise as far as it will go, then turn it counterclockwise until the presentation is steady.

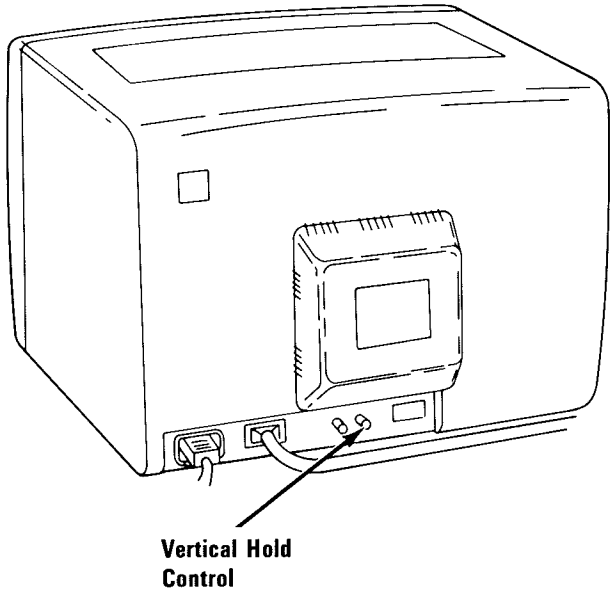

20 Were you able to make the presentation steady?

YES - Go to the next step.

NO - Have the display serviced.

21 Does the screen have white characters on a dark background?

YES - Go to Step 27.

NO - Go to the next step.

22 Set the Power switch on the system unit (and expansion unit, if attached) to Off.

23 Set the display's Power control to Off.

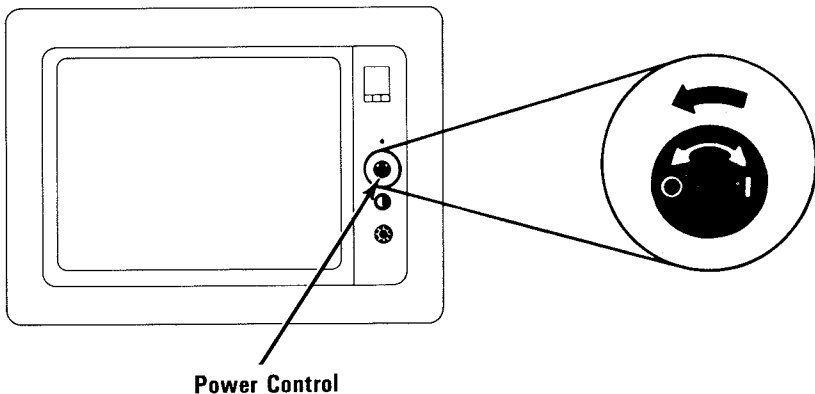

24 Disconnect the display's signal cable from the system unit (or expansion unit).

25 Set the display's Power control to On.

26 Is the screen white?

YES - Have the unit to which the display was attached serviced.

NO - Have the display serviced.

27 Turn the Brightness control fully counterclockwise.

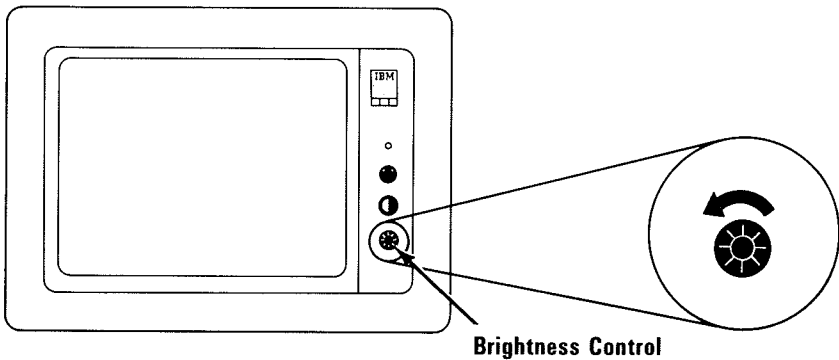

28 Does the intensity of the characters decrease?

YES - Go to the next step.

NO - Have the display serviced.

- 29** Turn the Brightness control fully clockwise and the Contrast control fully counterclockwise.

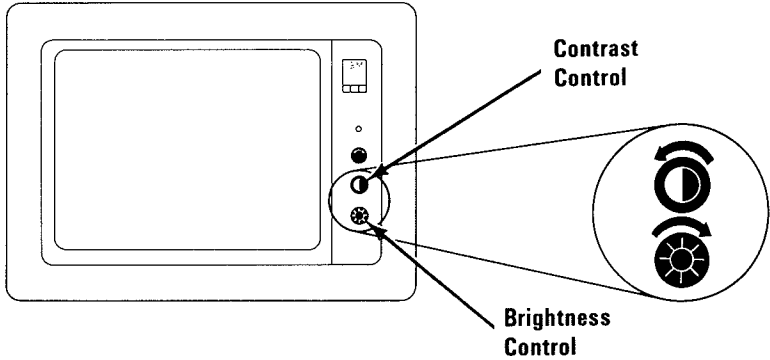

- 30** Does the intensity of the characters decrease?

YES - Go to the next step.

NO - Have the display serviced.

31 Turn the Contrast control fully clockwise. Can you find your problem in the following examples?

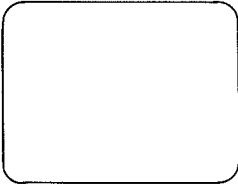

Too Dim

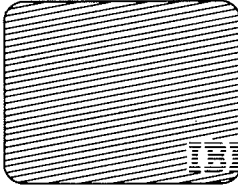

Too Wide

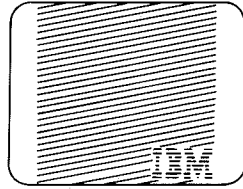

Too Narrow

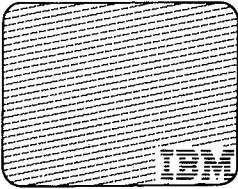

Out of Focus

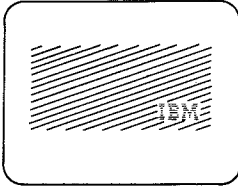

Shrunken

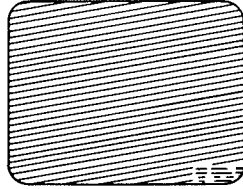

Characters shifted left or right or up and down off the display area

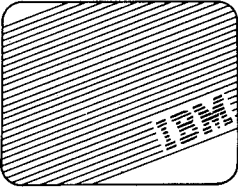

Tilted

YES - Have your display serviced.

NO - Go to "Diagnostic Testing" on page Test 000-1 earlier in this section.

SECTION 3. OPERATING YOUR IBM PERSONAL COMPUTER XT

Contents

System Unit	3-3
Keyboard	3-5
The Typewriter Area	3-6
The Numeric Keypad	3-10
Cursor Controls	3-12
Function Keys	3-14
Diskette Drive	3-15
Expansion Unit	3-17
IBM Monochrome Display	3-18
IBM Color Display	3-19
Power-On Control	3-19
Contrast Control	3-19
Brightness Control	3-19
Vertical Hold Control	3-20
Vertical Size Control	3-21

Notes:

System Unit

The main component of your IBM Personal Computer XT is the system unit. It accomplishes all the processing and controlling operations for your system through a set of instructions called a program. The IBM Personal Computer XT comes with a program languaged, IBM BASIC, already installed and many programs are written in that language. However, you can also write programs for your IBM Personal Computer XT in several other IBM supported programming languages. Although a reference manual for IBM BASIC is included with your system unit, prior knowledge of general programming concepts will be very helpful in writing programs for your IBM Personal Computer XT. In addition, various program packages are available at your authorized IBM Personal Computer dealer to help you meet a variety of business and personal needs.

The system unit stores data on either the fixed disk drive or the diskette drive using an operating system such as the IBM Disk Operating System (DOS). IBM DOS allows the system unit to store and retrieve data from either the fixed disk drive or the diskette drive. The reference manuals *Disk Operating System* and *BASIC* describe the commands needed to store or retrieve data. If you choose to write your own operating system, the IBM Personal Computer XT *Technical Reference* manual will provide valuable information.

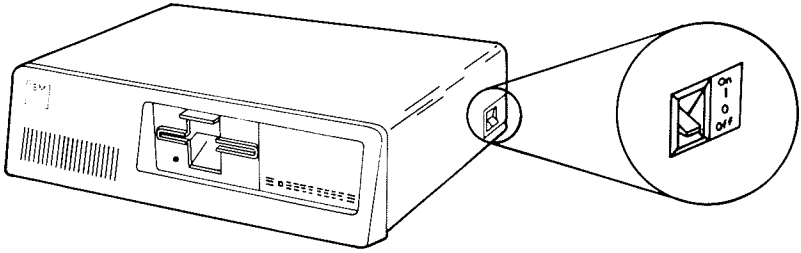

To operate the system unit, just set the Power switch to On. You can then send commands to the system through the keyboard; responses from the system will be displayed. If you have a printer attached to your system unit, you may also request a printed copy of almost any data in the system.

Keyboard

The keyboard consists of three sections: the typewriter area, the function keys, and the numeric keypad.

All keys are typematic; that is, they repeat as long as you hold them down.

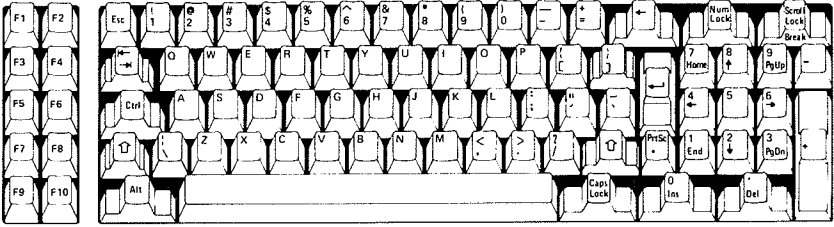

**Function
Keys**

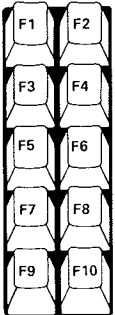

Typewriter Area

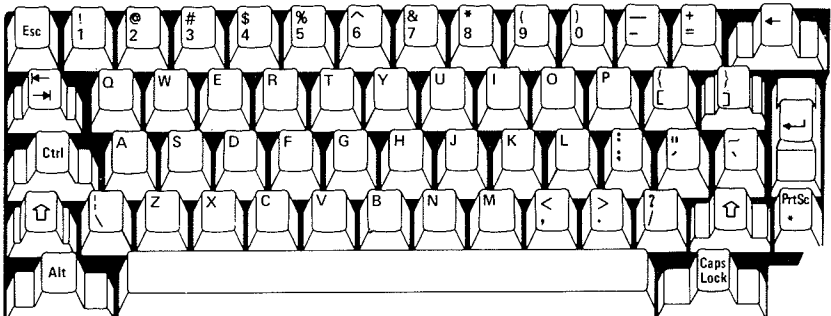

**Numeric
Keypad**

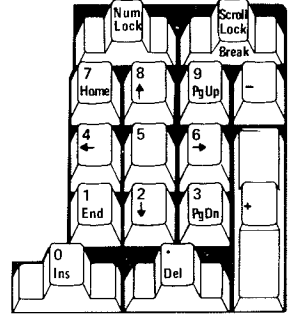

The Typewriter Area

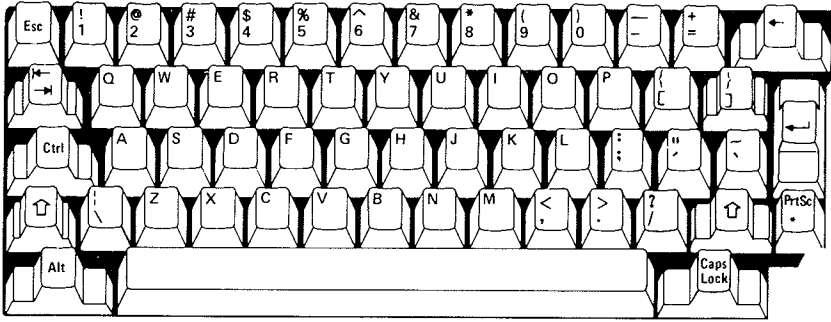

Key positions in the typewriter area are much like those of a standard typewriter. Some additional keys, however, perform control functions.



The Caps Lock key, when pressed once, locks the characters A through Z in the uppercase position. To shift to lowercase characters while Cap Lock is on, press the Shift key. Press the Caps Lock key again to release the uppercase mode for characters A through Z.



This is the Enter key. Its purpose is defined by the programming language or application you are using. Refer to the appropriate manual for its specific function.



When the Print Screen key is pressed along with the Shift key, a copy of the screen presentation is printed. If the information on the screen is alpha/numeric characters, as in a program listing, a duplicate of the information is printed. If the information is a graphic representation, it can be reproduced only on a printer that supports graphic printing, such as the IBM Graphics Printer.

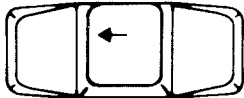

The Backspace key moves the cursor one position to the left. The character to the left of the cursor is erased.

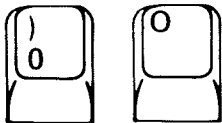

When entering data into your computer, be aware that the number zero (0) and the letter O are not interchangeable.

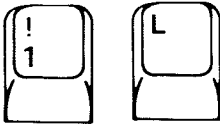

As with the zero and O, the number 1 and the lowercase letter L are not interchangeable.

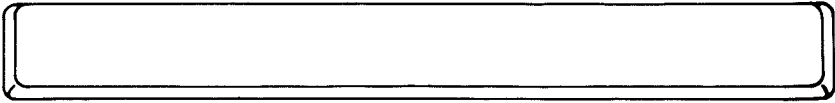

When pressed, the spacebar moves the cursor to the right. Any character the cursor moves over is replaced with a blank.

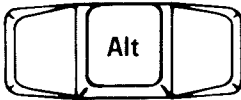

The Alternate key helps you with easy entry of BASIC statement keywords. When you press the Alt key and any alphabetic key A through Z, one of the BASIC keywords is entered. ASCII codes can also be entered by using the Alt key and the numeric keypad. For more information about the Alt key, see the *BASIC* reference manual.

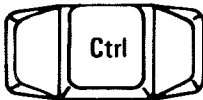

The Control key will perform a variety of functions. These are described in your operating system manual or application program manual.



The functions of the Escape key, also are described in your operating system or application program manual.

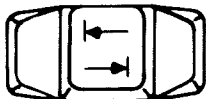

The Tab key moves the cursor to the next tab stop. Tab stops are defined in your operating system or application program manual.

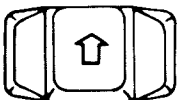

The keyboard has two shift keys, which are in the typewriter area. Pressing either of these changes the keys in the typewriter area to the uppercase mode. When alphabetic keys are pressed, the characters appear as capital letters. When other keys in the typewriter area are pressed, the characters shown on the upper portion of the keys appear.

The Numeric Keypad

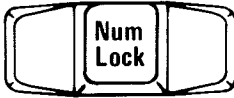

Pressing the Numeric Lock key once places keys 0 through 9 of the numeric keypad in the numeric state. Then when keys 0 through 9 are pressed, numbers appear on the screen. Pressing NumLock again returns keys 0 through 9 to cursor-control keys.



The purpose of the Scroll Lock key is defined in your operating system manual or application program manual.

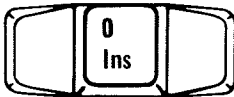

Pressing the Insert key enables you to add characters in the middle of a line. Press it again and you're back to normal operation.

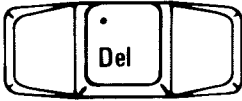

When you press the Delete key, the character at the current cursor position is erased and all characters to the right of the erased character move one position to the left.

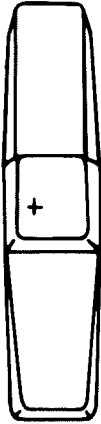

When the Plus and Minus keys are pressed, a plus or minus sign appears on the screen.

Cursor Controls

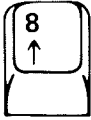
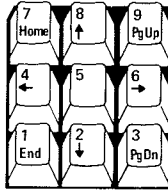

Cursor Up moves the cursor one line up.

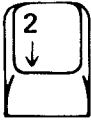

Cursor Down moves the cursor one line down.

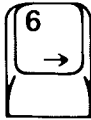

Cursor Right moves the cursor one character position to the right.



Cursor Left moves the cursor one character position to the left.



The function of the Home key is defined by your operating system or application program. See the appropriate manual for a description.

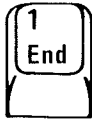

End moves the cursor one position to the right of the last character on the line.

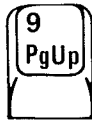

Page Up is defined by your operating system or application program. See the appropriate manual for a description.

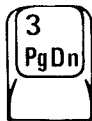

Page Down also is defined by your operating system or application program manual. See the appropriate manual for a description.

Function Keys



Function keys F1 through F10 are always under program control. See your operating system manual or application program manual.

Diskette Drive

The diskette drive is probably the most often used device in your system, besides the keyboard. It is used to load and store programs and data. For proper operation, follow the procedure below:

- 1 Raise the load lever.

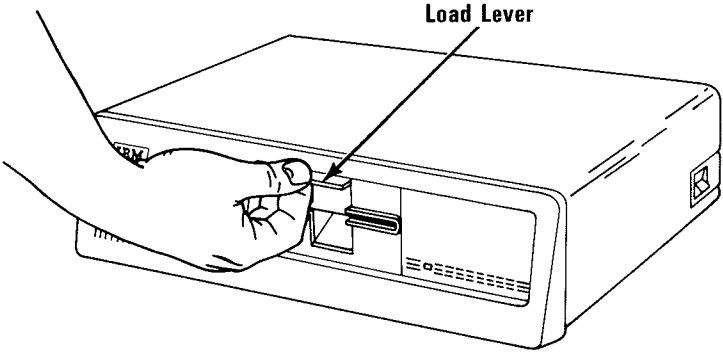

- 2 Insert the diskette into the drive.

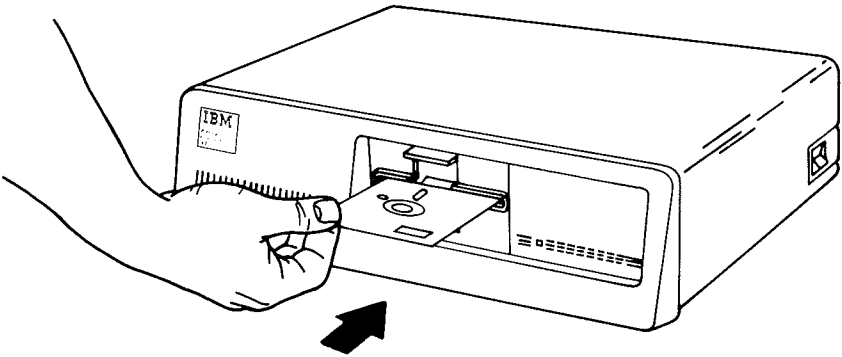

3 Lower the load lever.

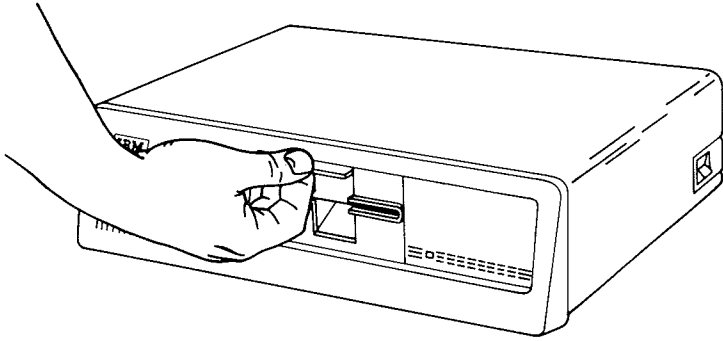

When the diskette drive is being used by the system, the In-Use light on the front of the drive will be on.

To remove a diskette from the drive, raise the load lever, pull out the diskette, then lower the load lever.

Expansion Unit

The expansion unit comes with a fixed disk drive. When you install the expansion unit, you have to remove the fixed disk drive and fixed disk adapter from the system unit and install them in the expansion unit. The fixed disk adapter then controls both fixed disk drives. You also have to install an extender card in the system unit. The extender card goes in the slot previously occupied by the fixed disk adapter. A cable connected to the extender card and to the receiver card in the expansion unit completes the electrical connection between the system unit and expansion unit.

The expansion unit has six expansion slots where additional options may be installed.

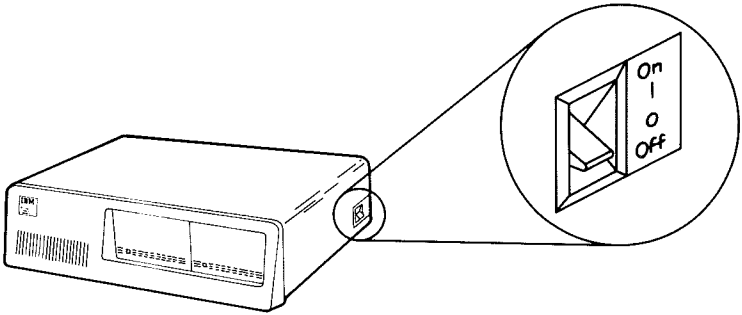

The expansion unit has only one control—the Power switch. When switching power on to the IBM Personal Computer XT, remember to switch on the expansion unit *before* the system unit. If this is not done, an error message will appear on the screen. To recover from this condition, you have to switch power off on all devices, then switch it back on, with the expansion unit being switched on first.

IBM Monochrome Display

Adjust the Contrast and Brightness controls for eye comfort.

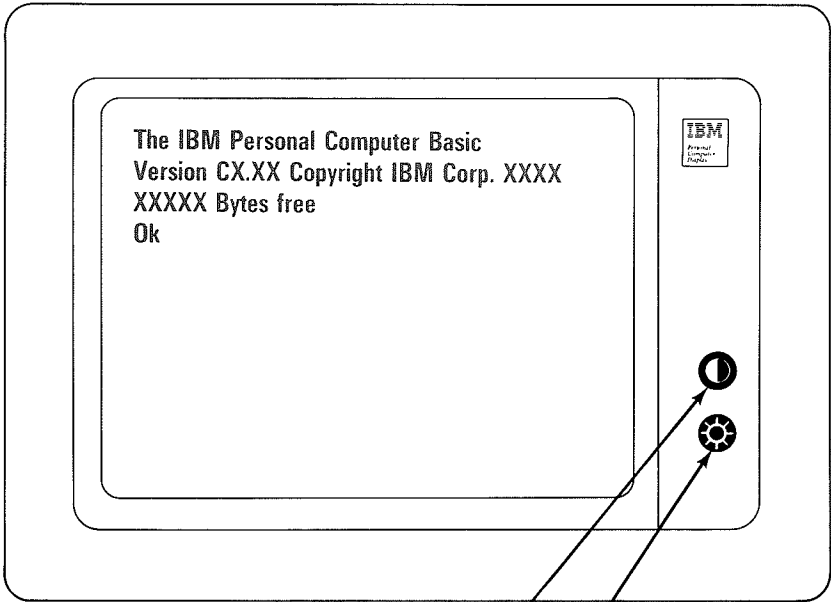

**Contrast
Control**



**Brightness
Control**



IBM Color Display

Power-On Control

The Power-On control, when turned clockwise, applies power to the IBM Color Display and removes power when turned counterclockwise. The Power-On indicator lights when display power is on.

Contrast Control

When the Contrast control is turned clockwise, it increases the brightness of black, blue, green, cyan, red, magenta, brown, and white. When turned counterclockwise, it decreases the brightness of these colors.

Brightness Control

The Brightness control, when turned clockwise, increases the brightness of the entire screen when turned clockwise, and decreases it when turned counterclockwise.

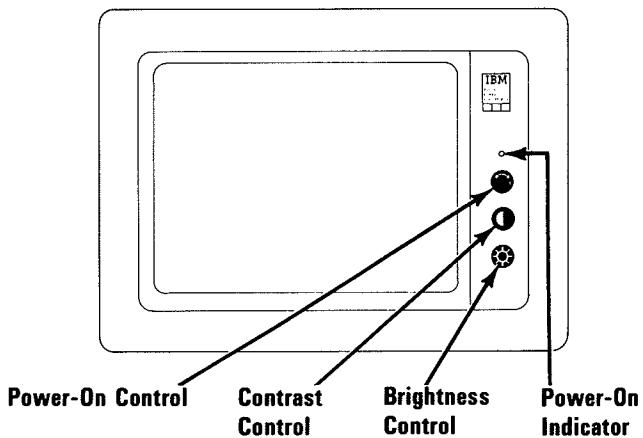

Vertical Hold Control

Use this control (as described below) only if your screen presentation is rolling from top-to-bottom or bottom-to-top.

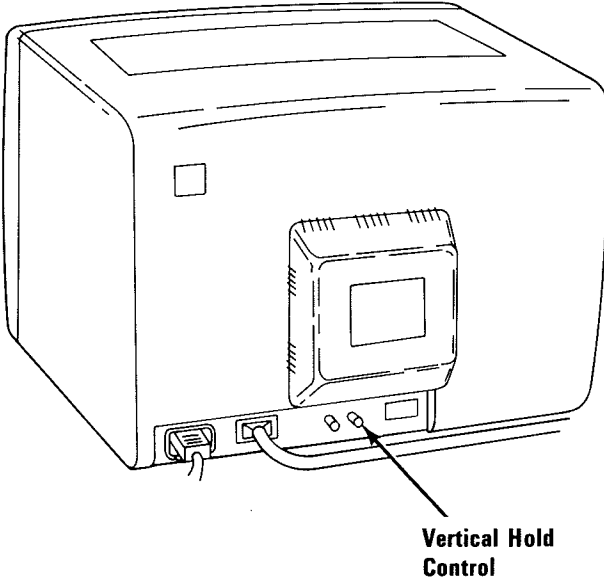

- 1** Set the system unit's Power switch and the display's Power control to On.
- 2** Wait for the completion of POST.
- 3** Turn the Vertical Hold control clockwise as far as it will go, then turn it counterclockwise until the screen presentation stops rolling.

Vertical Size Control

Use this control (as described below) only if the character size on your IBM Color Display is incorrect.

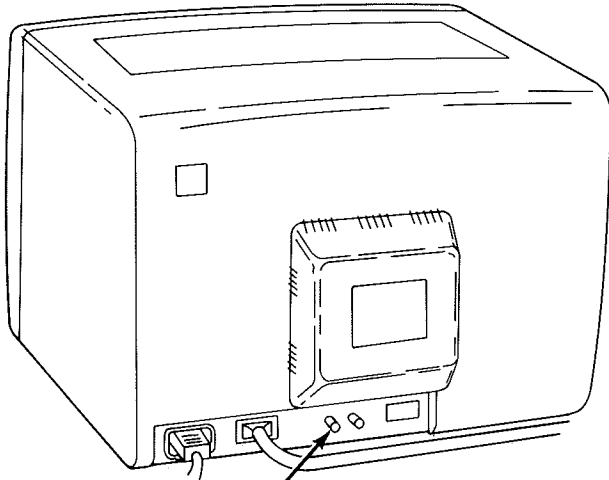

**Vertical Size
Control**

- 1** Set the Power switch on the system unit (and expansion unit, if attached) to Off.
- 2** Set the display's Power control to On.
- 3** Turn the Brightness and Contrast controls fully clockwise.
- 4** Turn the Vertical Size control fully counterclockwise. A black area appears across the top and bottom of the screen.

- 5** Turn the Vertical Size control clockwise until the black areas just disappear. If one of the black areas disappears before the other, continue to turn the control until the second black area is gone.

- 6** Adjust the Brightness and Contrast controls for eye comfort.

SECTION 4. OPTION INSTALLATION

Contents

How to Use This Section	4-3
Handling Static-Sensitive Devices	4-4
System Board Switches	4-7
Coprocesor	4-8
Memory	4-8
Displays	4-9
5-1/4 Inch Diskette Drives	4-10
Memory Option Switches	4-11
288K Total Memory	4-11
320K Total Memory	4-11
352K Total Memory	4-12
384K Total Memory	4-13
416K Total Memory	4-14
448K Total Memory	4-15
480K Total Memory	4-16
512K Total Memory	4-17
544K Total Memory	4-18
576 Total Memory	4-19
608 Total Memory	4-20
640K Total Memory	4-21
Extender Card Switches	4-22

Notes:

How to Use This Section

This section provides a place for you to file the instructions for installing the options you purchased for your IBM Personal Computer XT. Be sure to read "Handling Static-Sensitive Devices" before installing an option in your IBM Personal Computer XT. Because many of the options refer to switch settings, a complete list of the settings is also in this section.

After you install an option, file the installation instructions under the appropriate tab, as shown in the figure below.

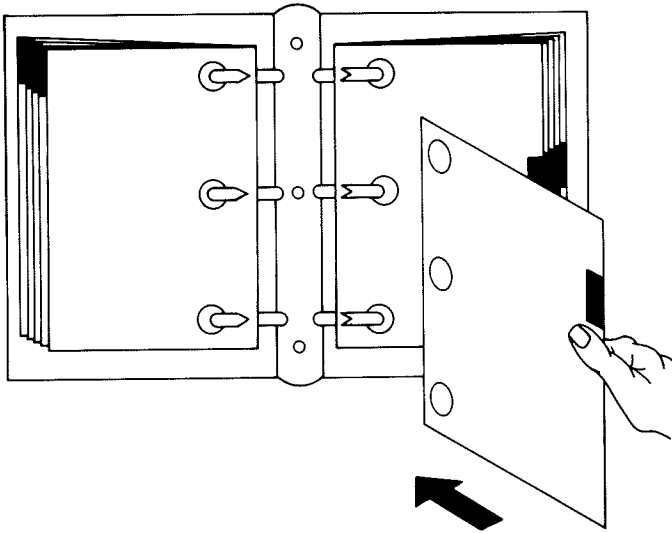

Switch Settings

Displays

Printers

Diskette/Disk

Memory

General

Communications

Handling Static-Sensitive Devices

Some components of the options for your IBM Personal Computer or IBM Personal Computer XT can be damaged by static discharges. To prevent such damage, your option may be wrapped in a conductive, anti-static bag; certain precautions should be taken before removing the option from its bag.

Hold the option (still wrapped in its anti-static bag) in one hand. Touch an *unpainted* metal part of your system unit (for example, the screws on the rear of the system unit) with the other hand. This will place your body, the option, and the system unit at the same ground potential, preventing an accidental static discharge.

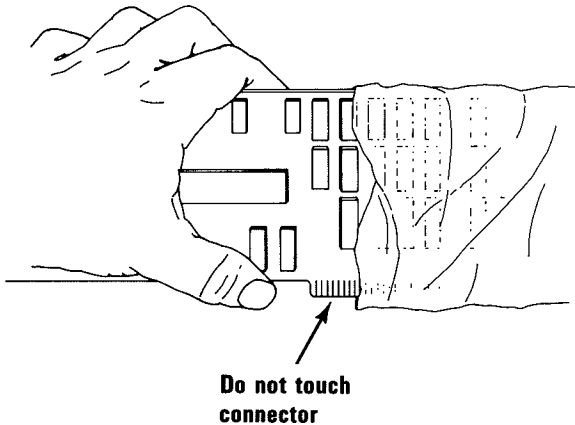

Carefully remove the option from its anti-static bag. Be sure to handle circuit boards by the edges only and do not touch the component pins or solder joints. Grasp diskette drives or fixed disk drives by their frames to avoid touching the circuit board. Memory chips should be held by their narrow ends only, not by their pins.

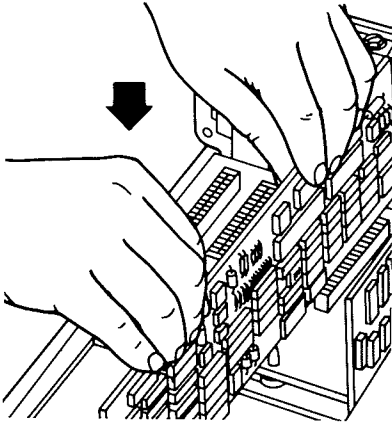

When inserting an option adapter into the system board, grasp it by its top edge or upper corners.

Notes:

System Board Switches

The switches on the system board are set as shown in the figure below and on the following pages. These settings are necessary for the system to address the attached devices and to specify the amount of memory on the system board.

Warning: Before you change any switch settings, make a note of how the switches are presently set.

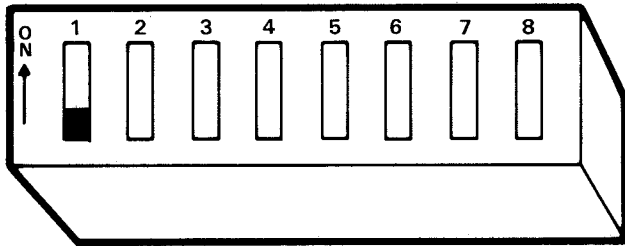

Switch Block

Note: Set a rocker switch by pressing down the rocker to the desired position. Push a slider switch to the desired position.

Switch	Function
1	Normal operation; always Off
2	Coprocessor
3-4	Amount of memory on the system board
5-6	Type of display attached
7-8	Number of 5-1/4 inch diskette drives installed

Coprocessor

Switch 2 is set to indicate if the coprocessor is installed.

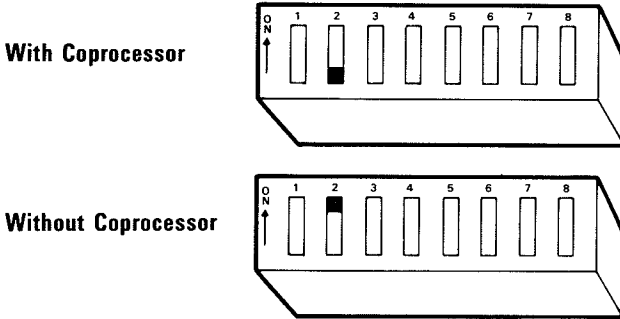

Memory

The following figure shows the settings for switches 3 and 4 for the amount of memory on the system board.

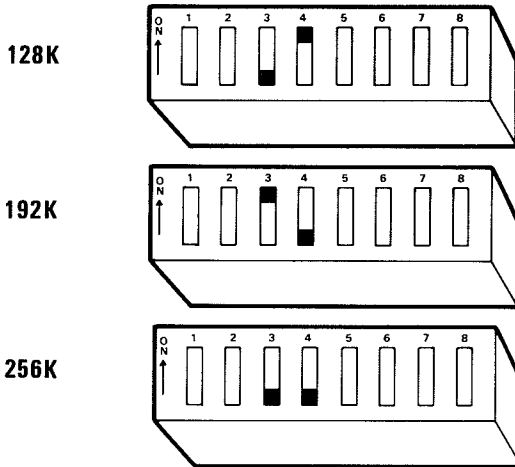

Note: The system board must be fully populated, 256KB of memory, before a memory expansion option can be installed.

Displays

The following figures show how switches 5 and 6 must be set for the type of display attached.

Warning: If an IBM Monochrome Display is connected to your system, switches 5 and 6 *must* be Off. Damage to your display can result from incorrect switch settings.

Warning: Damage to your IBM Monochrome Display may result if it is connected to an IBM Color/Graphics Monitor Adapter.

IBM Color/Graphics
Monitor Adapter in
the 40x25 Color mode

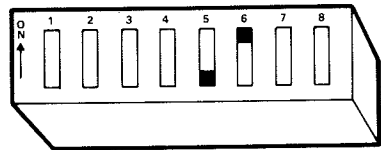

IBM Color/Graphics
Monitor Adapter in
the 80x25 Color mode

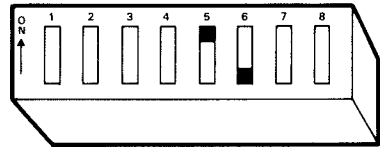

IBM Monochrome Adapter
or both IBM Monochrome
Adapter and IBM Color
Graphics Monitor Adapter

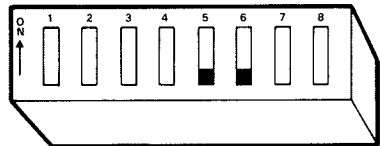

No Display

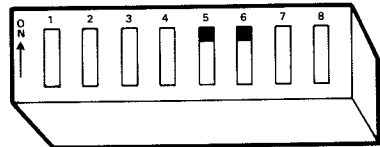

Note: The 40x25 Color mode means that there will be 40 characters across the screen and 25 lines down the screen. This mode is normally used with a home television. The 80x25 Color mode means there will be 80 characters across the screen and 25 lines down the screen. This mode, when used with home television and various displays, can cause loss of character quality.

5-1/4 Inch Diskette Drives

The following figures show how switches 7 and 8 must be set for the number of diskette drives installed.

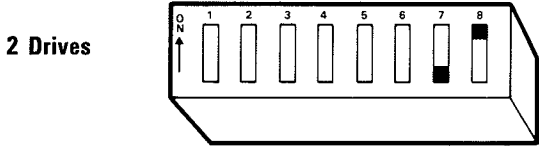
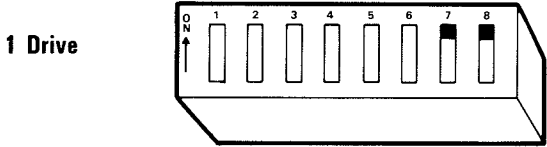

Memory Option Switches



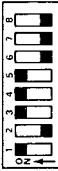
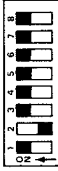

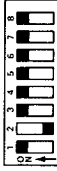
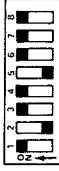

288K Total Memory 32K + 256K on System Board

1 - 32K option	64/256K Option Card Switches	64K Option Card Switches	32K Option Card Switches
			

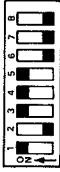



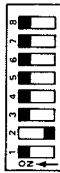

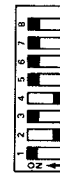

320K Total Memory 64K + 256K on System Board

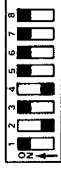
1 - 64/256K option with 64K installed	64/256K Option Card Switches	64K Option Card Switches	32K Option Card Switches
1 - 64K option			
2 - 32K options			 

**352K Total Memory
96K + 256K on System Board**

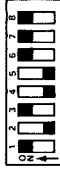
	64/256K Option Card Switches	64K Option Card Switches	32K Option Card Switches
1 - 64/256K option with 64K installed 1 - 32K option			
1 - 64K option 1 - 32K option			
3 - 32K options			  

**384K Total Memory
128K + 256K on System Board**

	64/256K Option Card Switches	64K Option Card Switches	32K Option Card Switches
1 - 64/256K option with 64K installed 1 - 64K option			
2 - 64K options		 	
1 - 64/256K option with 64K installed 2 - 32K options			 
1 - 64K option 2 - 32K options			 
1 - 64/256K option with 128K installed			





**416K Total Memory
160K + 256K on System Board**

	64/256K Option Card Switches	64K Option Card Switches	32K Option Card Switches
1 - 64/256K option with 64K installed 1 - 64K option 1 - 32K option			
2 - 64K options 1 - 32K option		 	
1 - 64/256K option with 128K installed 1 - 32K option			

**448K Total Memory
192K + 256K on System Board**

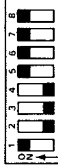
	64/256K Option Card Switches	64K Option Card Switches	32K Option Card Switches
1 - 64/256K option with 192K installed			
1 - 64/256K option with 128K installed 1 - 64K option			
1 - 64/256K option with 64K installed 2 - 64K options			
3 - 64K options			
1 - 64/256K option with 128K installed 2 - 32K options			

**480K Total Memory
224K + 256K on System Board**

	64/256K Option Card Switches	64K Option Card Switches	32K Option Card Switches
1 - 64/256K option with 192K installed 1 - 32K option			
1 - 64/256K option with 128K installed 1 - 64K option 1 - 32K option			

**512K Total Memory
256K + 256K on System Board**

	64/256K Option Card Switches	64K Option Card Switches	32K Option Card Switches
1 - 64/256K option with 128K installed 2 - 64K options			
1 - 64/256K option with 192K installed 1 - 64K option			
1 - 64/256K option with 192K installed 2 - 32K options			
1 - 64/256K option with 256K installed			







**544K Total Memory
288K + 256K on System Board**

	64/256K Option Card Switches	64K Option Card Switches	32K Option Card Switches
1 - 64/256K option with 192K installed 1 - 64K option 1 - 32K option			
1 - 64/256K option with 256K installed 1 - 32K option			

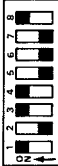

**576K Total Memory
320K + 256K on System Board**

	64/256K Option Card Switches	64K Option Card Switches	32K Option Card Switches
<p>1 - 64/256K option with 192K installed 2 - 64K options</p>			
<p>1 - 64/256K option with 256K installed 1 - 64/256K option with 64K installed</p>			
<p>1 - 64/256K option with 256K installed 1 - 64K option</p>			
<p>1 - 64/256K option with 256K installed 2 - 32K options</p>			

**608K Total Memory
352K + 256K on System Board**

	64/256K Option Card Switches	64K Option Card Switches	32K Option Card Switches
<p>1 - 64/256K option with 256K installed 1 - 64/256K option with 64K installed 1 - 32K option</p>	 		
<p>1 - 64/256K option with 256K installed 1 - 64K option 1 - 32K option</p>			

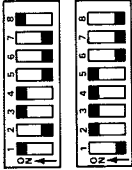
**640K Total Memory
384K + 256K on System Board**

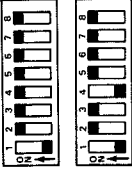
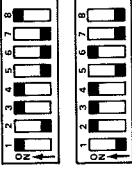
	64/256K Option Card Switches	64K Option Card Switches	32K Option Card Switches
<p>1 - 64/256K option with 256K installed 1 - 64/256K option with 64K installed 1 - 64K option</p>			
<p>1 - 64/256K option with 256K installed 2 - 64K options</p>			
<p>1 - 64/256K option with 256K installed 1 - 64/256K option with 128K installed</p>			

Extender Card Switches

Set the switches on the Extender Card to reflect total system memory.

Extender Card Switch Settings

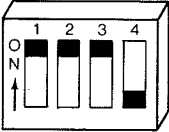
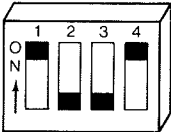
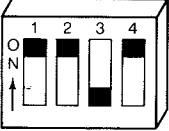
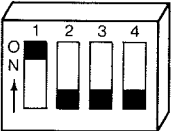
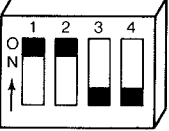
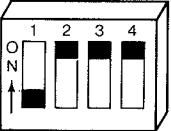
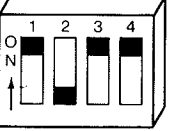
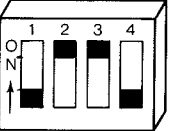
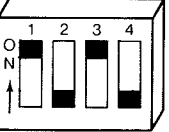
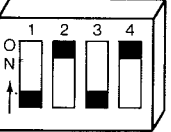
16K to 64K 	352K to 384K 
96K to 128K 	416K to 448K 
160K to 192K 	480K to 512K 
224K to 256K 	544K to 576K 
288K to 320K 	608K to 640K 

SECTION 5. MOVING YOUR IBM PERSONAL COMPUTER XT

Contents

Preparing the System	5-3
Short Distance Move	5-8
Long Distance Move	5-9
All Units	5-9
System Unit	5-9
Expansion Unit	5-10
Keyboard	5-11
IBM Monochrome or Color Display	5-12
IBM Graphics Printer	5-13
Installation at New Location	5-14

Notes:

Preparing the System

Warning: Normal shipping and handling can result in a permanent loss of all data on a fixed disk drive. We recommend that you back up all fixed-disk files onto diskettes before continuing with this procedure.

Depending on the amount of data stored, you may need as many as 32 diskettes to back up each fixed disk drive. Refer to the *Disk Operating System* manual for a description of the Backup command. Following is the procedure for preparing your system.

- 1** Insert the Diagnostics diskette.
- 2** Set the Power switch on the expansion unit (if attached) and system unit to On.

The following message appears on your screen.

**The IBM Personal Computer DIAGNOSTICS
Version XXX (C) Copyright IBM Corp XXXX, XXXX**

SELECT AN OPTION

0 - RUN DIAGNOSTIC ROUTINES

1 - FORMAT DISKETTE

2 - COPY DISKETTE

3 - PREPARE SYSTEM FOR RELOCATION

9 - EXIT TO SYSTEM DISKETTE

ENTER THE ACTION DESIRED

?

3

Press



then



This step moves the disk head over the highest available cylinder, which is the position designated for moving your system.

The following message appears on your screen.

SELECT AN OPTION

0 - RUN DIAGNOSTIC ROUTINES

1 - FORMAT DISKETTE

2 - COPY DISKETTE

3 - PREPARE SYSTEM FOR RELOCATION

9 - EXIT TO SYSTEM DISKETTE

ENTER THE ACTION DESIRED

? 3

SYSTEM READY FOR RELOCATION

- 4** Remove the diskette from the diskette drive unit.

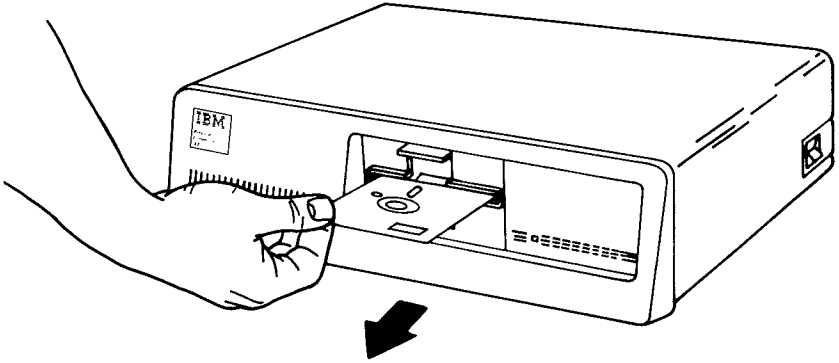

- 5** Set the Power switches to Off on all units (system unit, printer, etc.).

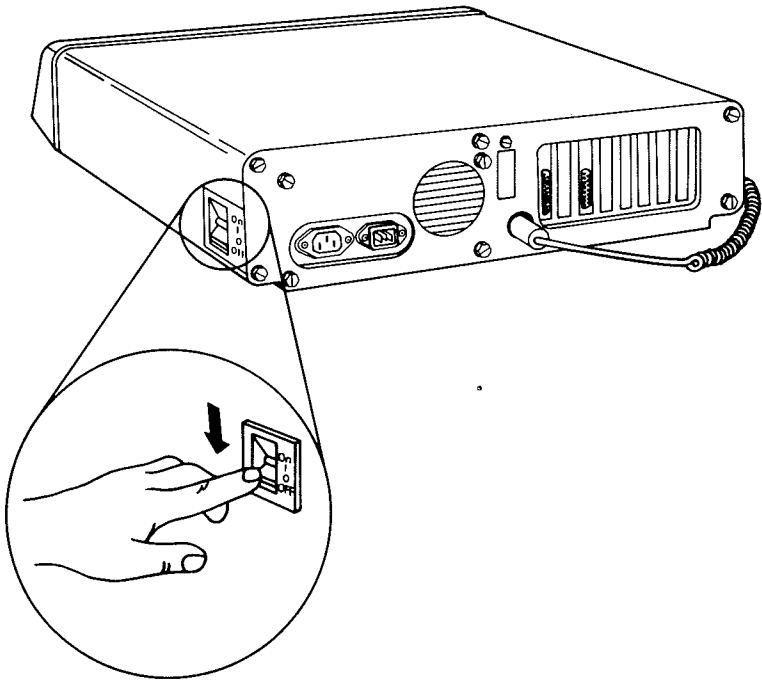

Note: Insert the shipping cardboard if you kept it as suggested in "Installation."

- 6** Unplug the system unit's (and expansion unit's) power cord from the wall outlet. Disconnect all cables from the rear of the units.

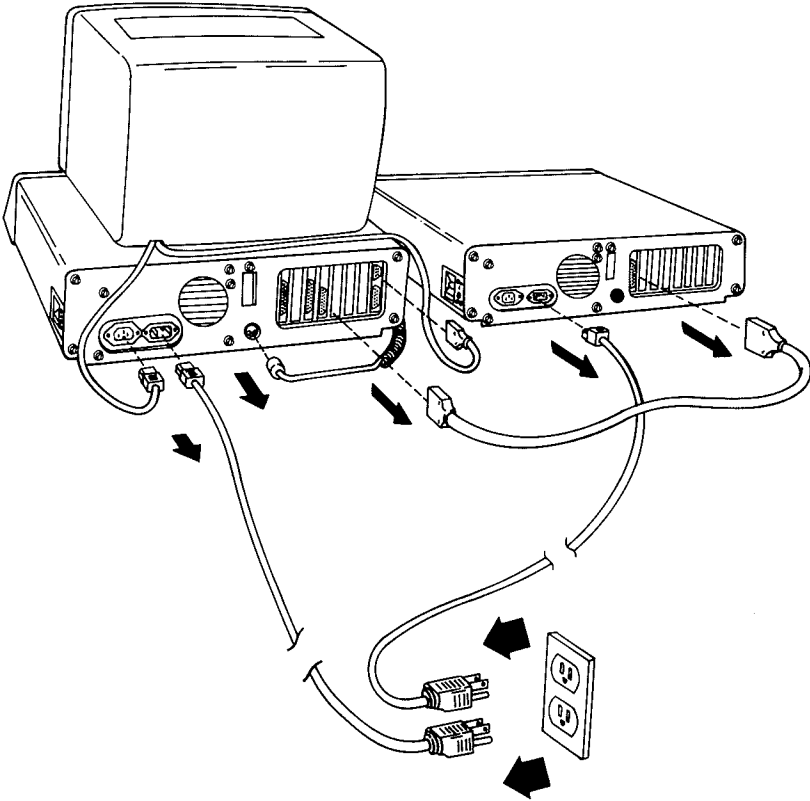

- 7** Coil the cables to protect the connectors.

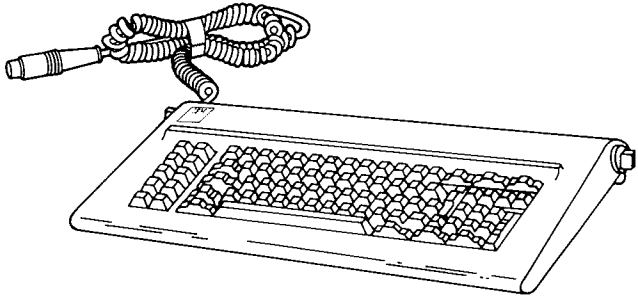

- 8** Tape the coiled cables to the system unit (and expansion unit) so the units may be carried safely. (We recommend using masking or filament tape.)

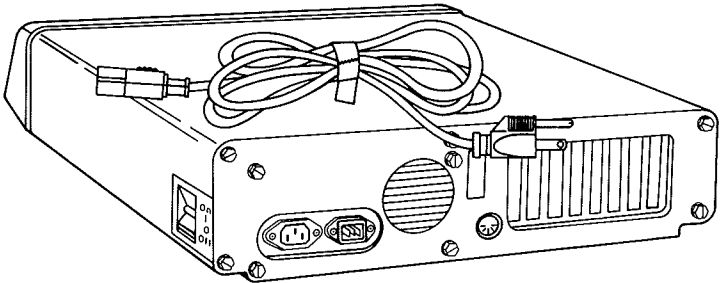

Short Distance Move

Short distance means any distance where trucking is not involved. For example, moving from one office or floor to another.

We recommend that each unit be moved separately.

Note: A second person may be helpful (doors, stairs, etc.).

Long Distance Move

All Units

If you still have the original shipping cartons and packing material, pack your units in them as shown below. If you are using different cartons, cushion the units well to avoid damage.

System Unit

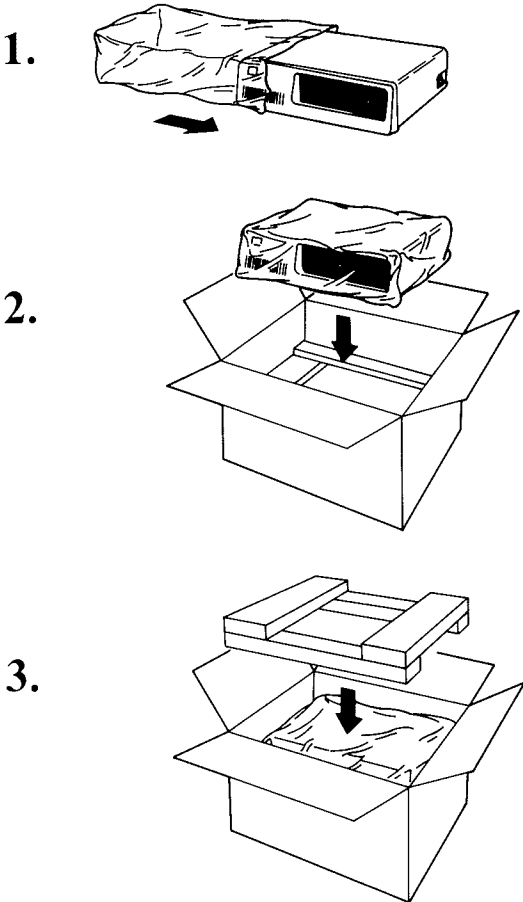

Expansion Unit

1.

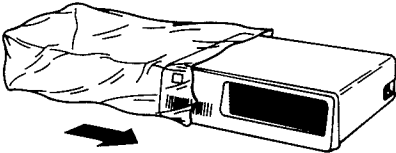

2.

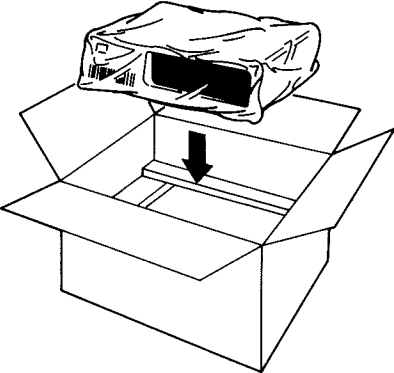

3.

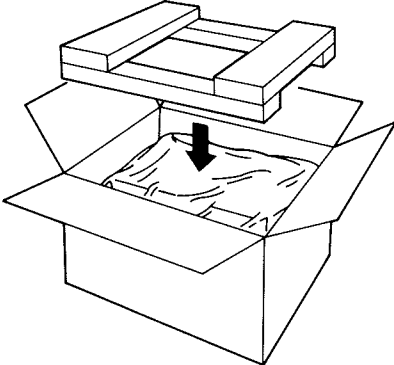

Keyboard

1.

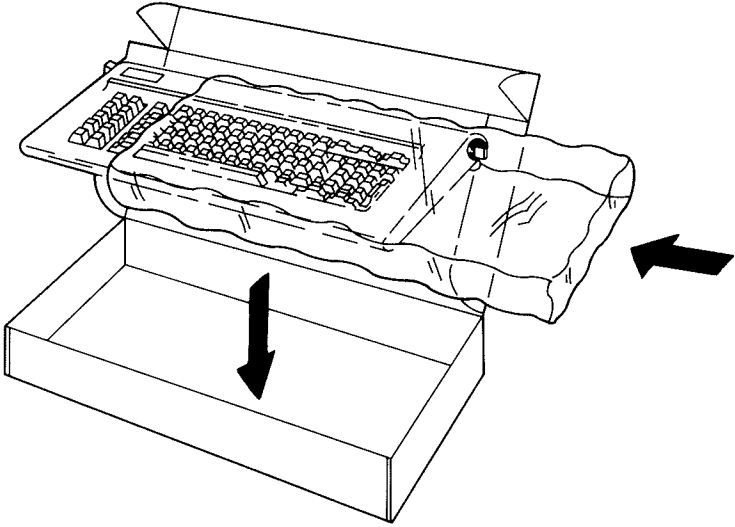

2.

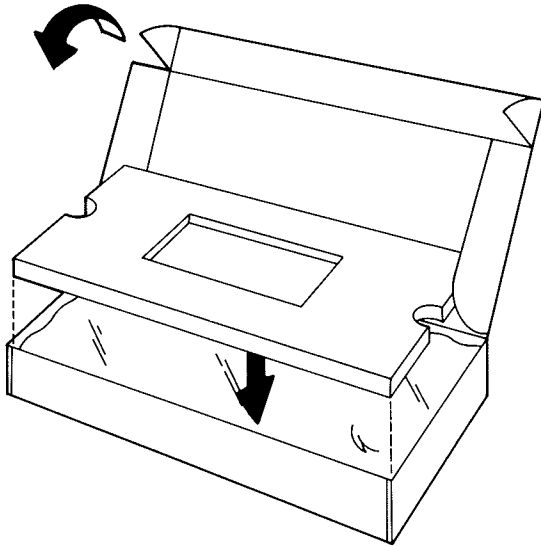

IBM Monochrome or Color Display

1.

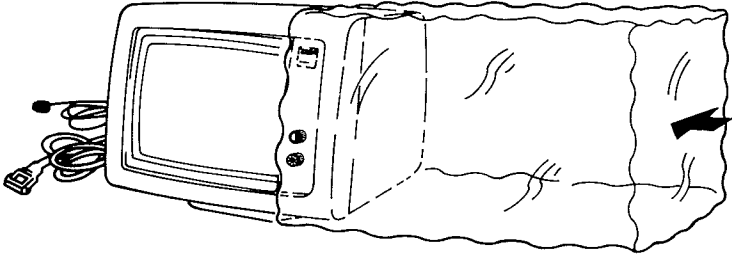

2.

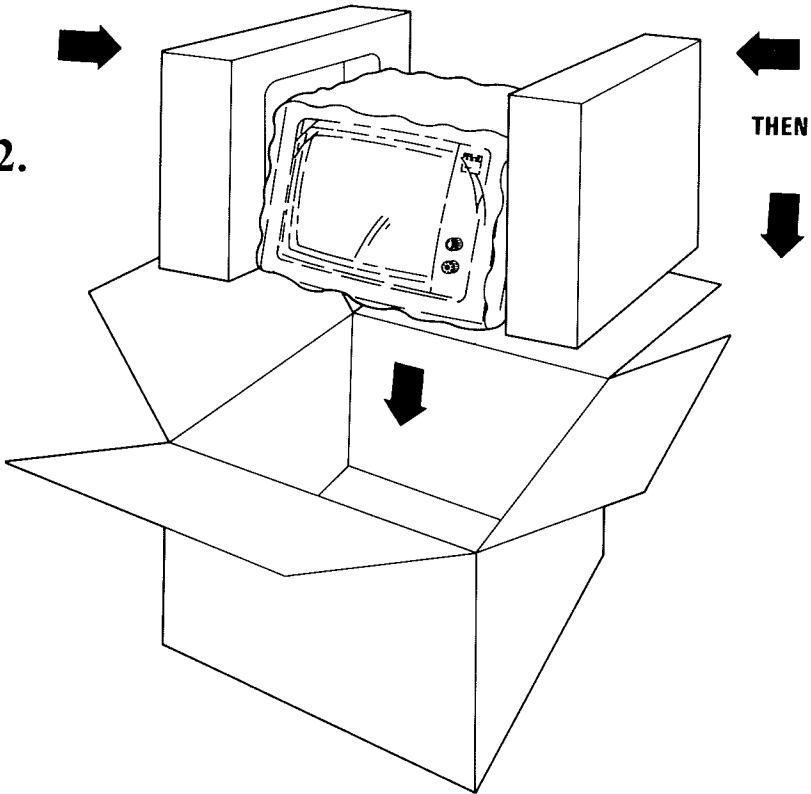

IBM Graphics Printer

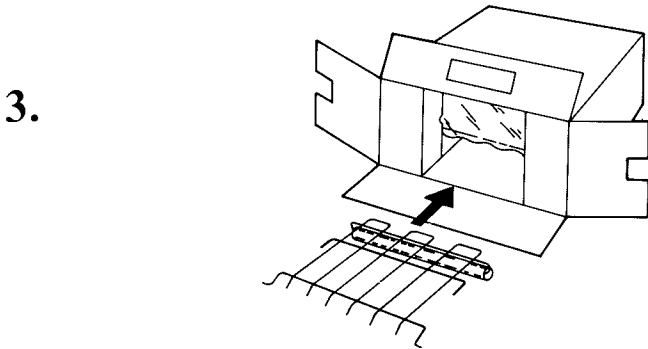
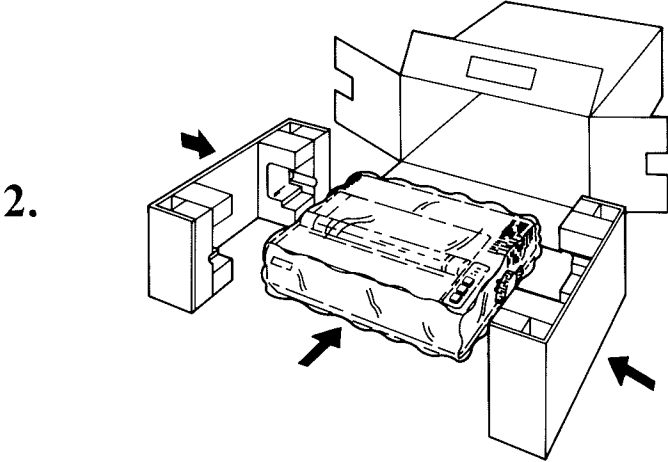
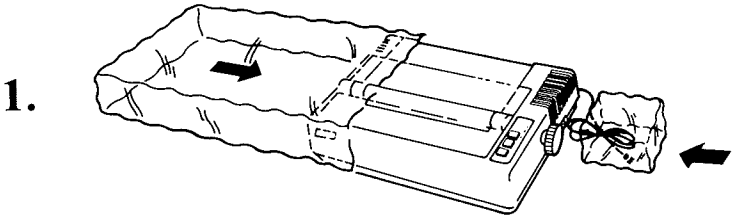

Note: The two shipping screws are not required for a local move.

Installation at New Location

When your system arrives at the new location, carefully unpack the system.

Install it as described in Section 1 of this manual.

IBM recommends that whenever you set up your system you perform a system checkout. This procedure is located in "Problem Determination Procedures."

If you have moved to a different country, refer to your local authorized IBM Personal Computer dealer for information about the proper cable for your system. If the country voltage is different than the label on the back of your machine, do not plug it in! Contact your dealer.

SECTION 6. KEYBOARD TEMPLATES

Contents

Introduction	6-3
French	6-5
German	6-7
Italian	6-9
Spanish	6-11
U.K. English	6-13
U.S. English	6-15

Notes:

Introduction

This section has figures showing the layouts of available keyboards. These figures are intended to be cut out (or reproduced) and used as templates for the various languages provided on a National DOS diskette.

If you do not use DOS, your keyboard converts all keystrokes as if you had a U.S. English keyboard, and you should use the U.S. English template as a guide.

Each figure in this section consists of two parts. Tape the parts together to form the template and set the template in the pencil tray above the keys.

Notes:

French

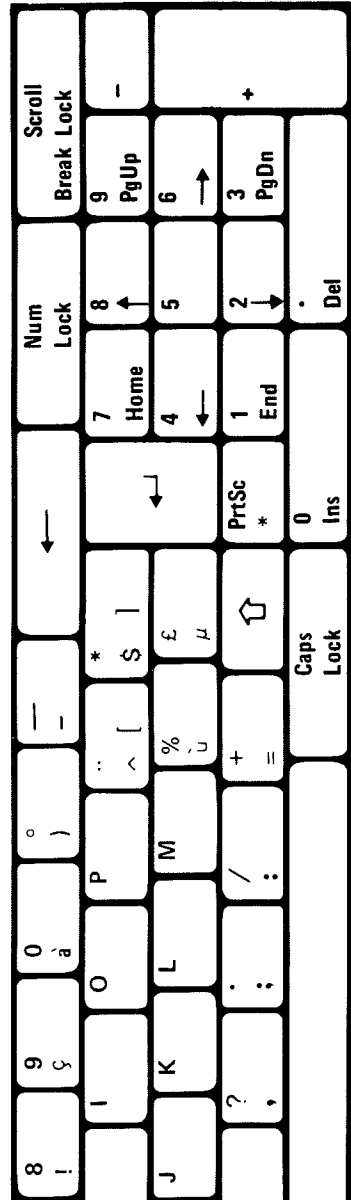
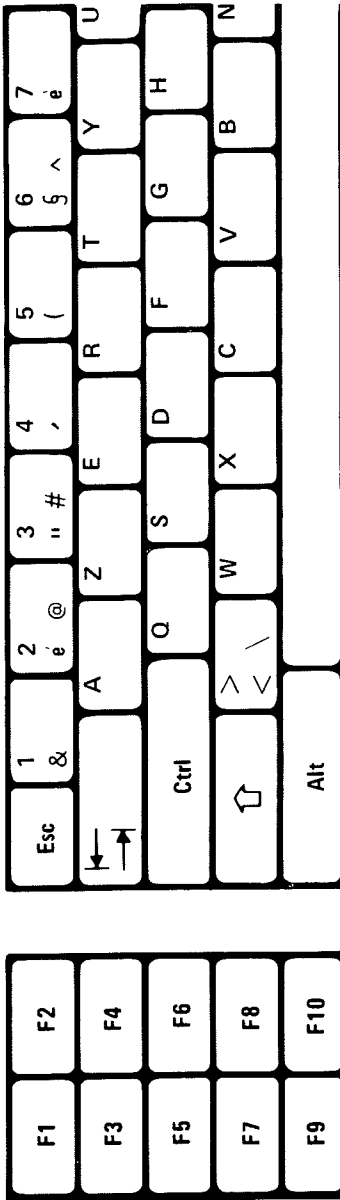

This template may be reproduced by the owner of the manual for the owner's use. If the owner transfers this manual, any copies made must be destroyed or transferred with the manual.

CARACTERES SUPPLEMENTAIRES

1. Appuyez et maintenez

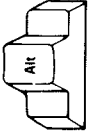

2. Frappez le code de trois chiffres sur le clavier numérique.

3. Relachez

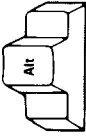

96	·	160	á	169	┌	226	Γ	235	ó	244	∫	254	■
123	{	161	í	170	└	227	π	236	∞	245	÷		
124	[162	ó	171	½	228	Σ	237	∅	246	÷		
125	}	163	ú	172	¼	229	σ	238	€	247	≈		
126	~	164	ñ	173	ı	230	μ	239	∩	249	•		
127	◁	165	Ñ	174	«	231	τ	240	≡	250	•		
128	◃	166	ë	175	»	232	ϕ	241	±	251	√		
134	à	167	ü	224	∞	233	ϕ	242	≥	252	∩		
141	ı	168	ı	225	β	234	Ω	243	≤	253	²		
143	Å												
144	É												
145	œ												
146	Æ												
149	ö												
155	¢												
157	¥												
158	Pls												
159	f												

This chart may be reproduced by the owner of the manual for the owner's use. If the owner transfers this manual, any copies made must be destroyed or transferred with the manual.

German

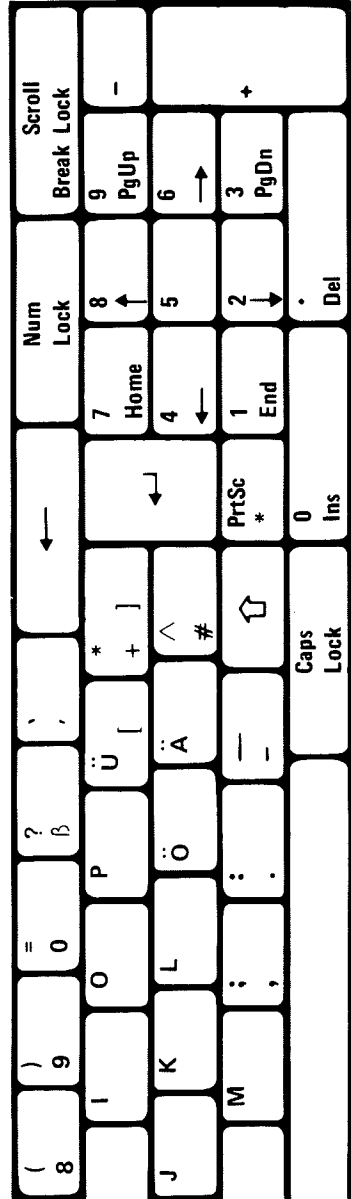
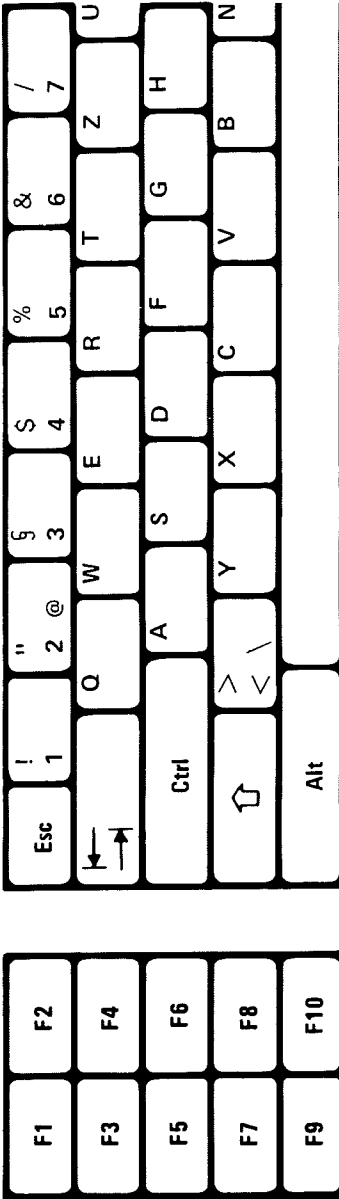

This template may be reproduced by the owner of the manual for the owner's use. If the owner transfers this manual, any copies made must be destroyed or transferred with the manual.

ZUSÄTZLICHE ZEICHEN

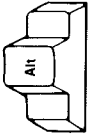

1. Betätigen und halten.

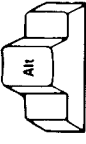

3. loslassen.

2. Ein 3-Zahlencode auf der Addiermaschinentastatur eingeben.

123	{	136	ê	167	∅	224	∞	234	Ω	243	≤	252	∞
124		139	ï	168	¿	226	Γ	235	δ	244	∫	253	²
125	}	140	ı	169	┌	227	π	236	∞	245	÷	254	■
126	~	141	ı	170	└	228	Σ	237	∅	246	÷		
127	◊	143	Å	171	½	229	σ	238	€	247	≈		
128	◊	145	æ	172	¼	230	μ	239	∩	248	◊		
131	ä	146	€	173	ı	231	τ	240	≡	249	•		
134	ä	147	ô	174	«	232	◊	241	±	250	•		
135	ç	150	û	175	»	233	⊕	242	≥	251	√		

This chart may be reproduced by the owner of the manual for the owner's use. If the owner transfers this manual, any copies made must be destroyed or transferred with the manual.

Italian

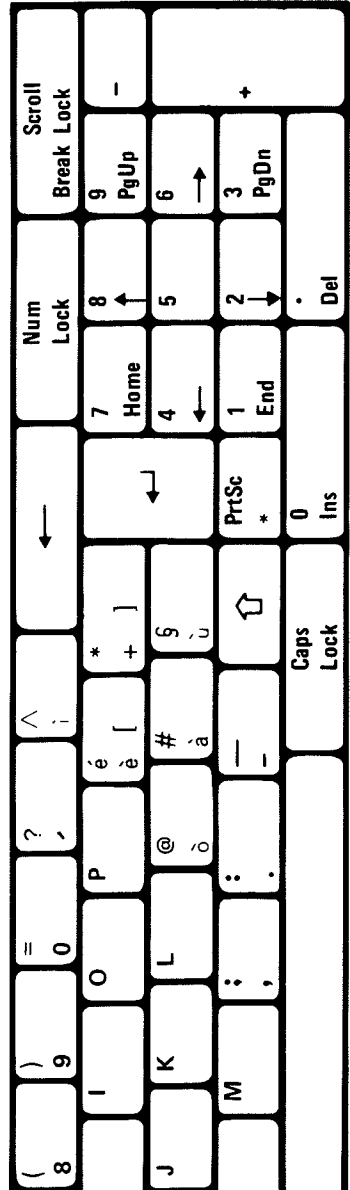
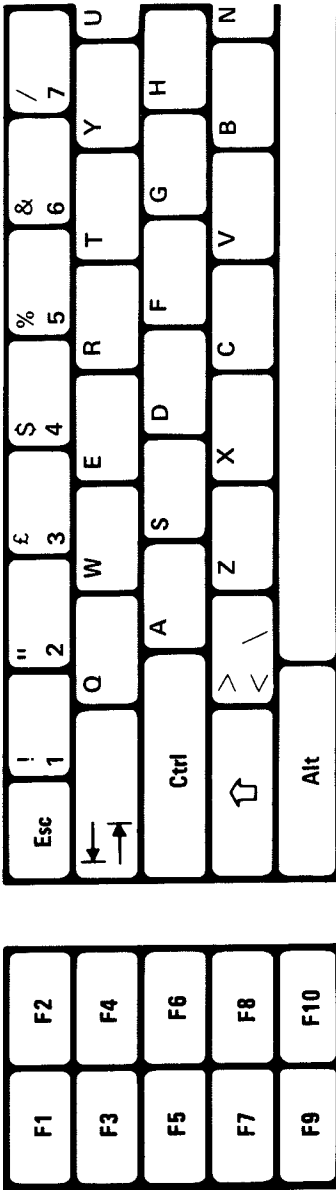

This template may be reproduced by the owner of the manual for the owner's use. If the owner transfers this manual, any copies made must be destroyed or transferred with the manual.

CARATTERI AGGIUNTIVI

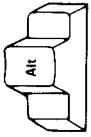

1. Premere e tenere premuto il tasto
2. Battere un codice di tre cifre sulla tastiera numerica.
3. Rilasciare il tasto

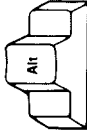

96	·	137	ë	148	ö	160	á	169	┌	226	┌	235	δ	244	∫	253	²
127	◻	139	ï	150	û	161	í	170	└	227	π	236	∞	245	∫	254	■
128	◻	140	ı	152	ÿ	162	ó	171	½	228	Σ	237	∅	246	÷	255	
129	ü	142	Ä	153	Ö	163	ü	172	¼	229	σ	238	€	247	≈		
131	ä	143	Å	154	Ü	164	ñ	173	ı	230	μ	239	∩	248	°		
132	ä	144	É	155	€	165	Ñ	174	«	231	τ	240	≡	249	•		
134	ä	145	æ	157	¥	166	ä	175	»	232	ϕ	241	±	250	·		
135	ç	146	Æ	158	Pts	167	ö	224	∞	233	⊕	242	≥	251	√		
136	ê	147	ö	159	f	168	ı	225	β	234	Ω	243	≤	252	n		

This chart may be reproduced by the owner of the manual for the owner's use. If the owner transfers this manual, any copies made must be destroyed or transferred with the manual.

CARACTERES ADICIONALES

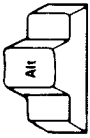

1. Pulse y mantenga pulsada la tecla 
2. Teclee un código de 3 dígitos en el teclado numérico (Lado derecho del teclado)



3. Libere

123 {	156 £	172 ¼	230 μ	239 ∩	248 °
124	157 ₣	174 «	231 τ	240 ≡	249 •
125 }	158 Pts	175 »	232 ♂	241 ±	250 •
126 ~	159 f	224 ∞	233 ⊖	242 ≥	251 √
127 □	166 ¢	225 β	234 Ω	243 ≤	252 n
134 à	167 ¢	226 Γ	235 δ	244 ∫	253 ²
145 æ	169 —	227 π	236 ∞	245 ∫	254 ■
146 Æ	170 —	228 Σ	237 Ø	246 ÷	
155 €	171 ½	229 σ	238 €	247 ≈	

This chart may be reproduced by the owner of the manual for the owner's use. If the owner transfers this manual, any copies made must be destroyed or transferred with the manual.

U.K. English

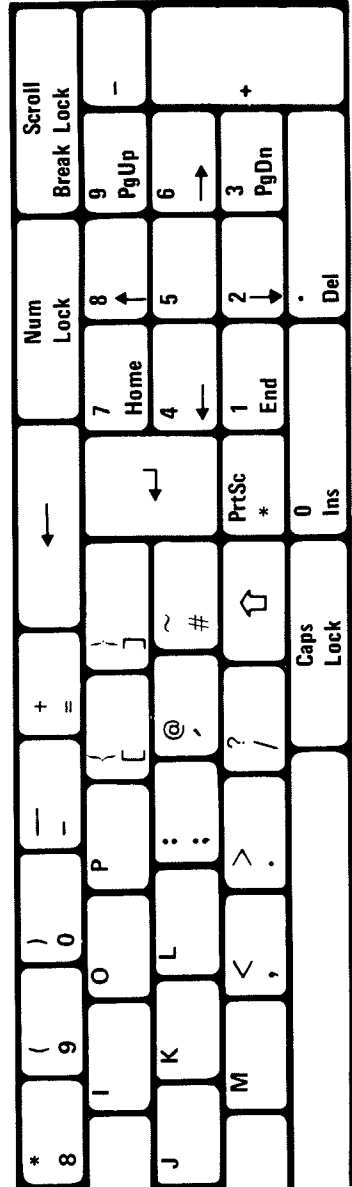
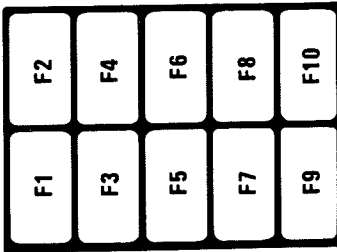
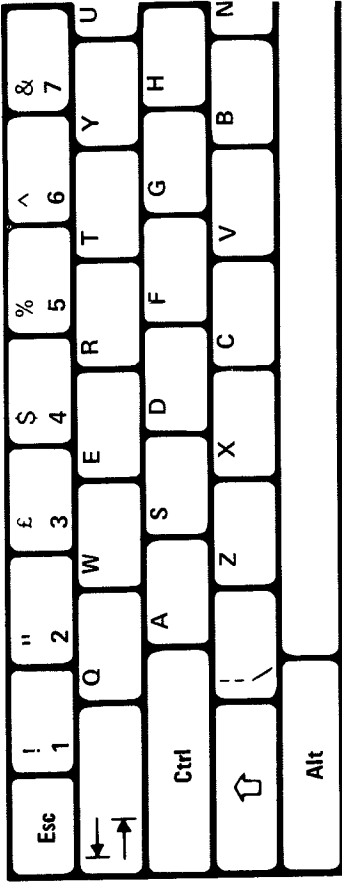

This template may be reproduced by the owner of the manual for the owner's use. If the owner transfers this manual, any copies made must be destroyed or transferred with the manual.

U.S. English

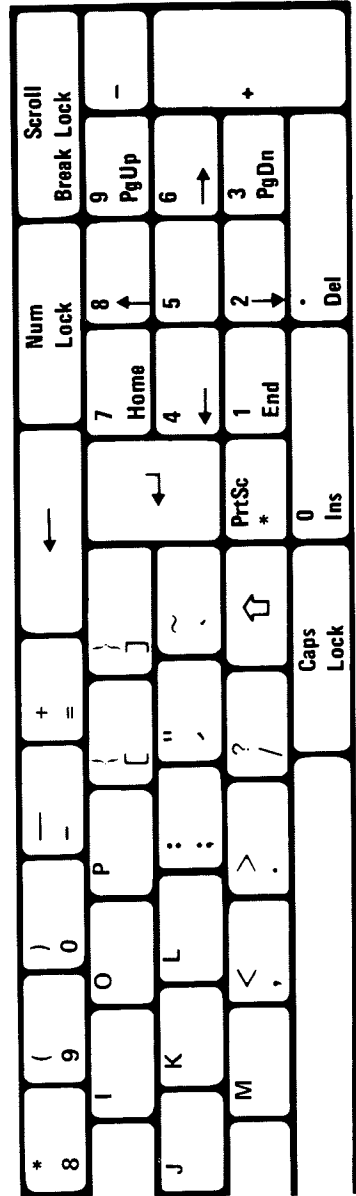
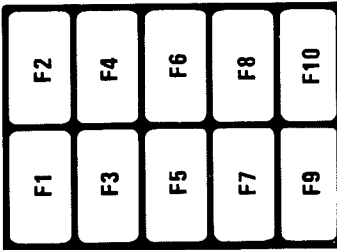
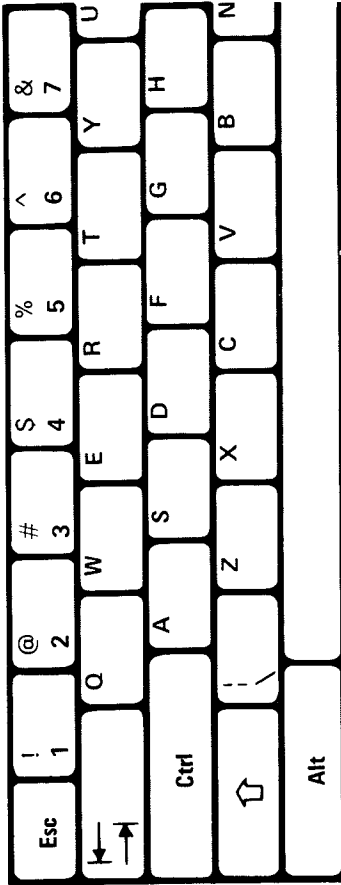

This template may be reproduced by the owner of the manual for the owner's use. If the owner transfers this manual, any copies made must be destroyed or transferred with the manual.

GLOSSARY

adapter. An auxiliary device or unit used to extend the operation of another system.

ASCII. American Standard Code for Information Interchange. The standard code, using a coded character set consisting of 7-bit coded characters (8 bits including parity check), used for information exchange between data processing systems, data communication systems, and associated equipment. The ASCII set consists of control characters and graphic characters.

backup. Duplicating data from a fixed disk drive or diskette to a diskette which ensures availability of data in the event of loss or damage to the original.

BASIC. Beginner's all-purpose symbolic instruction code. A programming language that uses common English words.

basic input/output system (BIOS). The feature of the IBM Personal Computer that provides the level control of the major I/O devices, and relieves the programmer from concern about hardware device characteristics.

binary synchronous communications (BSC). A uniform procedure, using a standardized set of control characters and control character sequences for synchronous transmission of binary-coded data between stations.

BIOS. Basic input/output system.

BSC. Binary synchronous communications.

byte. (1) A sequence of eight adjacent binary digits that are operated upon as a unit. (2) A binary character operated upon as a unit. (3) The representation of a character.

characters per second (cps). A standard unit of measurement for the speed at which a printer prints.

computer. A functional unit that can perform substantial computation, including numerous arithmetic operations or logic operations, without intervention by a human operator during a run.

cps. Characters per second.

CPU. Central processing unit.

cursor. (1) In computer graphics, a movable marker that is used to indicate a position on a display. (2) A displayed symbol that acts as a marker to help the user locate a point in text, in a system command, or in storage. (3) A movable spot of light on the screen of a display device, usually indicating where the next character is to be entered, replaced, or deleted.

data. (1) A representation of facts, concepts, or instructions in a formalized manner suitable for communication, interpretation, or processing by human or automatic means. (2) Any representations, such as characters or analog quantities, to which meaning is, or might be assigned.

DIP. Dual in-line package.

DIP switch. One of a set of small switches mounted in a dual in-line package.

disk. Loosely, a magnetic disk.

diskette. A thin, flexible magnetic disk and a semirigid protective jacket, in which the disk is permanently enclosed. Synonymous with flexible disk.

diskette drive. A device for storing data on and retrieving data from a diskette.

display. (1) A visual presentation of data. (2) A device for visual presentation of information on any temporary character imaging device. (3) To present data visually.

EIA/CCITT. Electronic Industries Association/International Telegraph and Telephone Consultative Committee.

FCC. Federal Communications Commission.

fixed disk drive. In the IBM Personal Computer, a unit consisting of nonremovable magnetic disks, and a device for storing data on and retrieving data from the disks.

flexible disk. Synonym for diskette.

format. The arrangement or layout of data on a data medium.

hardware. (1) Physical equipment used in data processing, as opposed to programs, procedures, rules, and associated documentation. (2) Contrast with software.

head. A device that reads, writes, or erases data on a storage medium; for example, a small electromagnet used to read, write, or erase data on a magnetic disk.

interface. A device that alters or converts actual electrical signals between distinct devices, programs, or systems.

joystick. In computer graphics, a lever that can pivot in all directions and that is used as a locator device.

Kb. Kilobyte; 1024 bytes.

load. In programming, to enter data into storage or working registers.

magnetic disk. (1) A flat circular plate with a magnetizable surface layer on which data can be stored by magnetic recording. (2) See also diskette.

Mb. Megabyte; 1,048,576 bytes.

microprocessor. An integrated circuit that accepts coded instructions for execution; the instructions may be entered, integrated, or stored internally.

modem (modulator-demodulator). A device that converts serial (bit by bit) digital signals from a business machine (or data communication equipment) to analog signals that are suitable for transmission in a telephone network. The inverse function is also performed by the modem on reception of analog signals.

module. (1) A program unit that is discrete and identifiable with respect to compiling, combining with other units, and loading. (2) A packaged functional hardware unit designed for use with other components.

monitor. Synonym for cathode ray tube display (CRT display).

most-significant digit. The leftmost (non-zero) digit. See also high-order position.

NTSC. National Television System Committee. A group that has set United States television broadcast standards.

operating system. Software that controls the execution of programs; an operating system may provide services such as resource allocation, scheduling, input/output control, and data management.

output. Pertaining to a device, process, or channel involved in an output process, or to the data or states involved in an output process.

output process. (1) The process that consists of the delivery of data from a data processing system, or from any part of it. (2) The return of information from a data processing system to an end user, including the translation of data from a machine language to a language that the end user can understand.

paddle. A user supplied device that connects to the Game Control Adapter.

personal computer. A small home or business computer that has a processor and keyboard and that can be connected to a television or some other monitor. An optional printer is usually available.

power supply. A device that produces the power needed to operate electronic equipment.

processor. (1) In a computer, a functional unit that interprets and executes instructions. (2) A functional unit, a part of another unit such as a terminal or a processing unit, that interprets and executes instructions. (3) Deprecated term for processing program. (4) See microprocessor.

program. (1) A series of actions designed to achieve a certain result. (2) A series of instructions telling the computer how to handle a problem or task. (3) To design, write, and test computer programs.

programming language. (1) An artificial language established for expressing computer programs. (2) A set of characters and rules with meanings assigned prior to their use, for writing computer programs.

programming system. One or more programming languages and the necessary software for using these languages with particular automatic data-processing equipment.

prototype card. A blank circuit card which can be used to create custom adapters.

RAM. Random access memory. Read/write memory.

random access memory (RAM). Read/write memory.

read-only memory (ROM). A storage device whose contents cannot be modified. The memory is retained when power is removed.

read/write memory. A storage device whose contents can be modified. Also called RAM.

reverse video. A form of highlighting a character, field, or cursor by reversing the color of the character, field,

or cursor with its background; for example, changing a red character on a black background to a black character on a red background.

RF. Radio frequency.

RF modulator. The device used to convert the composite video signal to the antenna level input of a home TV.

ROM. Read-only memory.

ROM/BIOS. The ROM resident basic input/output system, which provides the level control of the major I/O devices in the computer system.

run. A single continuous performance of a computer program or routine.

schematic. The representation, usually in a drawing or diagram form, of a logical or physical structure.

SDLC. Synchronous Data Link Control.

sector. That part of a track or band on a magnetic drum, a magnetic disk, or a disk pack that can be accessed by the magnetic heads in the course of a predetermined rotational displacement of the particular device.

setup. (1) In a computer that consists of an assembly of individual computing units, the arrangement of interconnections between the units, and the adjustments needed for the computer to operate. (2) The preparation of a computing system to perform a job or job step. Setup is usually performed by an

operator and often involves performing routine functions, such as mounting tape reels. (3) The preparation of the system for normal operation.

signal. A variation of a physical quantity, used to convey data.

software. (1) Computer programs, procedures, and rules concerned with the operation of a data processing system. (2) Contrast with hardware.

storage. (1) A storage device. (2) A device, or part of a device, that can retain data. (3) The retention of data in a storage device. (4) The placement of data into a storage device.

Synchronous Data Link Control (SDLC). A protocol for management of data transfer over a data link.

synchronous transmission. (1) Data transmission in which the time of occurrence of each signal representing a bit is related to a fixed time frame. (2) Data transmission in which the sending and receiving devices are operating continuously at substantially the same frequency and are maintained, by means of correction, in a desired phase relationship.

syntax. (1) The relationship among characters or groups of characters, independent of their meanings or the manner of their interpretation and use. (2) The structure of expressions in a language. (3) The rules governing the structure of a language. (4) The relationships among symbols.

text. In ASCII and data communication, a sequence of characters treated as an entity if preceded and terminated by one start-of-text and one end-of-text transmission control character, respectively.

track. (1) The path or one of the set of paths, parallel to the reference edge on a data medium, associated with a single reading or writing component as the data medium moves past the component. (2) The portion of a moving data medium such as a drum, or disk, that is accessible to a given reading head position.

translate. To transform data from one language to another.

transmission. (1) The sending of data from one place for reception elsewhere. (2) In ASCII and data communication, a series of characters including headings and text. (3) The dispatching of a signal, message, or other form of intelligence by wire, radio, telephone, or other means. (4) One or more blocks or messages. For BSC and start-stop devices, a transmission is terminated by an EOT character. (5) Synonymous with data transmission.

typematic. Keyboard buttons that will repeat when held depressed.

video. Computer data or graphics displayed on a cathode ray tube, monitor, or display.

word. (1) A character string or a bit string considered as an entity. (2) See computer word.

write. To make a permanent or transient recording of data in a storage device or on a data medium.

Notes:

INDEX

A

adjustments

- brightness, color display 3-19
- brightness, monochrome display 3-18
- contrast, color display 3-19
- contrast, monochrome display 3-18
- screen alignment 1-20
- tilt position, keyboard 1-15
- vertical hold 3-20
- vertical size 3-21

Alternate key 3-8

B

Backspace key 3-7

Brightness control

- color display 3-19
- monochrome display 3-18

C

cabling, system 1-14

cabling

Caps Lock key 3-6

checking electrical connections 2-1

color display

controls 3-19

- moving 5-12
- vertical hold adjustment 3-20
- vertical size adjustment 3-21
- Contrast control
 - color display 3-19
 - monochrome display 3-18
- Control key 3-8
- controls
 - Brightness color display 3-19
 - Brightness, monochrome display 3-18
 - color display 3-19
 - Contrast, color display 3-19
 - Contrast, monochrome display 3-18
 - cursor down 3-12
 - cursor left 3-12
 - cursor right 3-12
 - cursor up 3-12
 - monochrome display 3-18

D

- Delete key 3-11
- diagnostic tests 2-1
- disk, fixed 3-17
- diskette
 - drive 3-15
 - handling 1-7
 - loading 1-21
- displays
 - IBM Color 3-19
 - IBM Monochrome 3-18

E

- End key 3-13
- Enter key 3-6

- error examples 2-1
- error messages 2-1
- Escape key 3-9
- expansion unit
 - operating 3-17
 - problem determination 2-1

F

- fixed disk 3-17
- function keys 3-14

G

- graphics printer, moving 5-13

H

- Home key 3-13
- how to
 - cable system unit 1-14
 - handle diskettes 1-7
 - install system unit 1-9

I

- Insert key 3-10
- installation, Personal Computer XT 1-9
- introduction 1-3

isolating problems 2-1

K

keyboard

- adjustment 1-15
- installation 1-10
- moving 5-11

keys

- Alternate 3-8
- Backspace 3-7
- Caps Lock 3-6
- Control key 3-8
- cursor controls 3-12
- Delete 3-11
- Enter 3-6
- Escape 3-9
- function 3-14
- Home 3-13
- Insert 3-10
- Minus 3-11
- Number Lock 3-10
- numeric keypad 3-10
- Plus key 3-11
- Print Screen 3-7
- Scroll Lock 3-10
- Shift 3-9
- Spacebar 3-8
- Tab 3-9
- typewriter area 3-6

L

lever, diskette load 3-15

lights

- color display (power on) 3-19

diskette (in-use) 3-16
loading diagnostics diskette 2-1

M

Minus key 3-11
monochrome display
 moving 5-12
 operating 3-18
moving
 color display 5-12
 keyboard 5-11
 monochrome display 5-12
 printers 5-13
 system unit 5-9

N

National DOS 6-3
Number Lock key 3-10
numeric keypad 3-10

O

option examples
 diskette drive 1-4
 fixed disk drive 1-4
 printers 1-4
options 1-5, 1-6

P

- Page Down 3-12
- Page Up 3-12
- Plus key 3-11
- POST, system unit 1-16
- Power Switch
 - color display 3-19
 - expansion unit 3-17
 - system unit 3-3
- Print Screen key 3-7
- problem determination procedures 2-3

S

- scratch diskette 2-3
- screen alignment 1-20
- Scroll Lock key 3-10
- service information 2-1
- Shift key 3-9
- Spacebar 3-8
- system unit 3-3
 - power-on self test 1-16
 - problem determination 2-1

T

- Tab key 3-9
- templates, National DOS 6-3
- typematic 3-5

U

units

expansion 3-17

system 3-3

typewriter area 3-6

V

vertical hold 3-20

vertical size 3-21

W

wrap plug 2-1

communication 2-1

Notes:



Reader's Comment Form

Guide to Operations

6137861

Your comments assist us in improving the usefulness of our publication; they are an important part of the input used for revisions.

IBM may use and distribute any of the information you supply in any way it believes appropriate without incurring any obligation whatever. You may, of course, continue to use the information you supply.

Please do not use this form for technical questions regarding the IBM Personal Computer or programs for the IBM Personal Computer, or for requests for additional publications; this only delays the response. Instead, direct your inquiries or request to your authorized IBM Personal Computer dealer.

Comments:

Tape

Please do not staple

Tape

Fold here

IBM PERSONAL COMPUTER
SALES & SERVICE
P.O. BOX 1328-C
BOCA RATON, FLORIDA 33432

POSTAGE WILL BE PAID BY ADDRESSEE

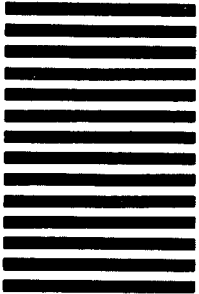

BUSINESS REPLY MAIL
FIRST CLASS PERMIT NO. 321 BOCA RATON, FLORIDA 33432

NO POSTAGE
NECESSARY
IF MAILED
IN THE
UNITED STATES





Reader's Comment Form

Guide to Operations

6137861

Your comments assist us in improving the usefulness of our publication; they are an important part of the input used for revisions.

IBM may use and distribute any of the information you supply in any way it believes appropriate without incurring any obligation whatever. You may, of course, continue to use the information you supply.

Please do not use this form for technical questions regarding the IBM Personal Computer or programs for the IBM Personal Computer, or for requests for additional publications; this only delays the response. Instead, direct your inquiries or request to your authorized IBM Personal Computer dealer.

Comments:

Tape

Please do not staple

Tape

Fold here

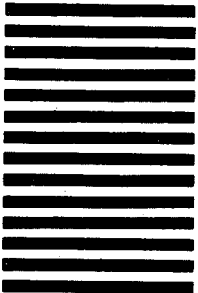

IBM PERSONAL COMPUTER
SALES & SERVICE
P.O. BOX 1328-C
BOCA RATON, FLORIDA 33432

POSTAGE WILL BE PAID BY ADDRESSEE

BUSINESS REPLY MAIL
FIRST CLASS PERMIT NO. 321 BOCA RATON, FLORIDA 33432

NO POSTAGE
NECESSARY
IF MAILED
IN THE
UNITED STATES





Reader's Comment Form

Guide to Operations

6137861

Your comments assist us in improving the usefulness of our publication; they are an important part of the input used for revisions.

IBM may use and distribute any of the information you supply in any way it believes appropriate without incurring any obligation whatever. You may, of course, continue to use the information you supply.

Please do not use this form for technical questions regarding the IBM Personal Computer or programs for the IBM Personal Computer, or for requests for additional publications; this only delays the response. Instead, direct your inquiries or request to your authorized IBM Personal Computer dealer.

Comments:

Tape

Please do not staple

Tape

Fold here

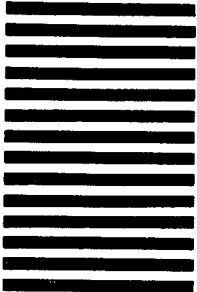

IBM PERSONAL COMPUTER
SALES & SERVICE
P.O. BOX 1328-C
BOCA RATON, FLORIDA 33432

POSTAGE WILL BE PAID BY ADDRESSEE

BUSINESS REPLY MAIL
FIRST CLASS PERMIT NO. 321 BOCA RATON, FLORIDA 33432

NO POSTAGE
NECESSARY
IF MAILED
IN THE
UNITED STATES

