



ATLAS

DVR/PVR 5-DEVICE

Universal Remote Control



User's Guide

TABLE OF CONTENTS

Introduction	3
Features And Functions	4
Key Charts	5
Device Table	8
Installing Batteries	9
Programming Device Control	10
Programming TV/VCR Combo Control	12
Manufacturer's Codes	13
Setup Codes For Audio Amplifiers	13
Setup Codes For Audio Receivers	13
Setup Codes For Cable Boxes (Converters)	15
Setup Codes For DVD Players	15
Setup Codes For Satellite Receivers	16
Setup Codes For TVs	17
Setup Codes For TV/VCR Combos	20
Setup Codes For VCRs And PVRs	21
Searching For Your Code	24
Checking The Codes	25
Programming Channel Control Lock	26
To De-Activate Channel Control Lock	26
To Re-Activate Channel Control Lock	26
Programming ID Lock	27
Programming "Tune-In" Keys For Specific Channels ...	27
To Program A "Tune-In" Key	28
To Clear A "Tune-In" Key	28
Using The Master Power Key	29
To Program The Master Power Key	29
To Operate The Master Power Key	29
To Clear The Master Power Key	29
Re-Assigning Device Keys	30
Changing Volume Lock	31
To Unlock Volume Control For A Single Device (Individual Volume Unlock)	31
To Unlock All Volume Control (Global Volume Unlock)	31
To Lock Volume Control To One Mode (Global Volume Lock)	32
Troubleshooting	33
Instructions To The User	34
Additional Information	35

INTRODUCTION

The Atlas DVR/PVR 5-Device Universal Remote Control by Universal Electronics is our latest generation universal remote control. Its sophisticated technology allows you to consolidate up to five of your original home entertainment remote controls into one easy-to-use product. Moreover, it's packed with advanced features such as:

- Preprogrammed control to operate the cable converter supplied by your cable service provider
- Dedicated keys to control popular functions on your DVR/PVR (Digital/Personal Video Recorder)
- Programmable Master Power key for master on/off control of your home entertainment equipment with a single keystroke
- Instant "Tune-In" keys for assignment to your favorite channels
- Channel Lock to lock channel selection only to the cable converter
- Volume Lock to lock volume controls to one mode or individual modes
- Device Key Re-Assignment to remotely control a second (duplicate) device
- Code Search to help program control of older or discontinued components
- Color-coded keys to quickly locate popular functions
- Code library for popular video and audio devices

Before using the product, you will need to install the enclosed batteries and also perform some programming to operate the specific home entertainment devices you wish to control.

Please follow the instructions detailed in this manual to set up the unit and then start enjoying your new remote control and cable service.

FEATURES AND FUNCTIONS

Use the illustration below to locate features on the Atlas DVR/PVR 5-Device Universal Remote Control and then study the *Key Charts* (on the next three pages) to learn how they function.

To find out what type of devices can be controlled by each device key after programming, see the *Device Table* on page 8.

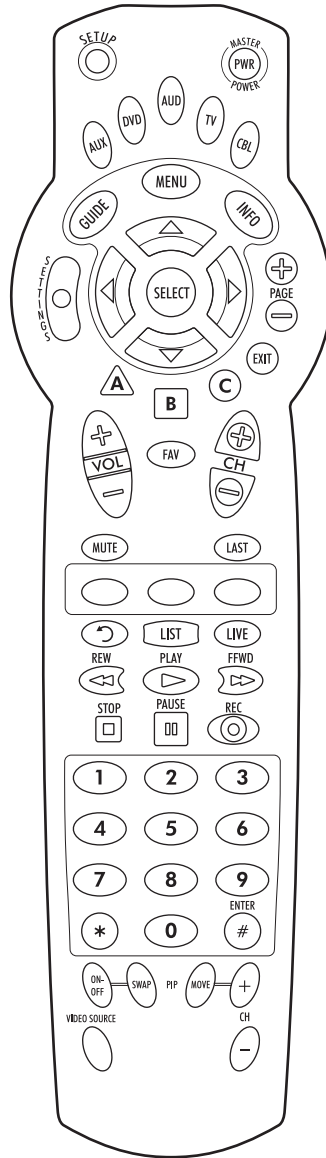

Key Charts



Use **SETUP** for all programming sequences.



Press **PWR** once to turn on or off a home entertainment device. For **MASTER POWER** control, see *Using The Master Power Key* on page 29.



Press **AUX**, **DVD**, **AUD**, **TV**, or **CBL** once to select a home entertainment device to control. Also see the *Device Table* on page 8.

Each device key has an embedded LED (red light) that blinks upon selection and indicates the remote control is working and (after programming) is sending signals.



Use **GUIDE** to display the program guide.



Press **MENU** once to display available interactive services.



Use **INFO** to display the current channel and program information.



Press **SETTINGS** once to access additional cable features.



Use the **Cursor** keys to move the cursor in the program guide and menu screens and to navigate within the interactive service.

Use **SELECT** to choose options, PPV events, and to tune programs from the program guide.



Use **PAGE+** (or **PAGE-**) to page up (or page down) through menu screens and the program guide.



Use **EXIT** to exit out of your cable converter's menu and guide.



Use **A**, **B**, or **C** to access additional cable features (see your cable converter's manual).

continued on next page...

FEATURES AND FUNCTIONS

Key Charts (continued)



Use VOL+ (or VOL-) to raise (or lower) the audio volume.



Use FAV to cycle through your favorite channels stored in your cable converter.



Use CH+ (or CH-) to select the next higher (or lower) channel.

For DVD players, use these keys to skip forward (or reverse) through chapters.

For amplifiers/receivers, use these keys to select the next higher (or lower) preset station.



Press MUTE once to turn the sound off or on.



Press LAST once to recall the last channel.



Reserved for use as "Tune-In" keys (see page 27).



Use  to command your PVR to instantly replay the last 7 seconds of a program you are watching.



Press LIST once to display a list of recorded shows on your PVR.





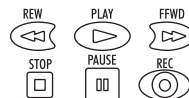



Press LIVE to return to watching live TV.







In all modes except CBL, use REW, PLAY, FFWD, STOP, and PAUSE to control a VCR, DVD player, or a PVR (after selecting a desired device). To record in the VCR mode, press REC twice.

In the CBL mode, use above keys to control DVR/PVR functions of the set-top box.



 Use the keypad numbers (1 ~ 9, and 0) to directly tune channels (e.g., 09). For amplifiers/receivers, use the keypad numbers to select inputs 1 through 10.







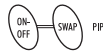

In the CBL mode, use ENTER to enter information and to access music channels.

In the TV, DVD, or AUX modes for certain devices, press ENTER once after entering a channel number. See your device's owner's manual.



Use PIP ON-OFF to switch the Picture-In-Picture feature on or off (if available on your TV or cable service).

Use PIP SWAP to switch images and sound between the main and window pictures.

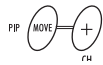

Use PIP MOVE to move the window picture to different positions in the main picture.

Use PIP CH+ (or CH-) to select the next higher (or lower) PIP channel.



In the CBL mode, use VIDEO SOURCE to view other video sources (A or B) instead of cable.





In all other modes, use VIDEO SOURCE to watch TV or video programs on a desired device. For amplifiers/receivers, use VIDEO SOURCE to select an input source.

FEATURES AND FUNCTIONS (continued)

Device Table

NOTE: Please refer to the table below when performing the instructions in "Programming Device Control" on page 10 or "Programming TV/ VCR Combo Control" on page 12.

After programming, the Atlas DVR/PVR 5-Device Universal Remote Control will be able to control the following types of devices:

DEVICE KEY	CONTROLS THESE TYPES OF DEVICES
	VCR, TV/VCR Combo, PVR (Personal Video Recorder), or extra DVD Player
	DVD Player
	Audio Amplifier, Tuner, or Receiver
	Television
	Cable Box (Converter) or Satellite Receiver

INSTALLING BATTERIES

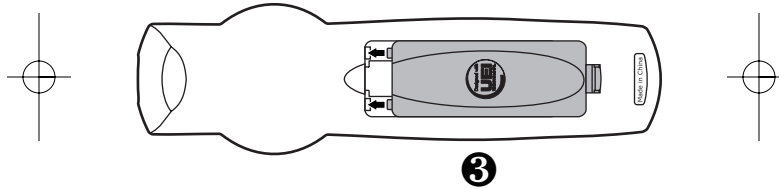
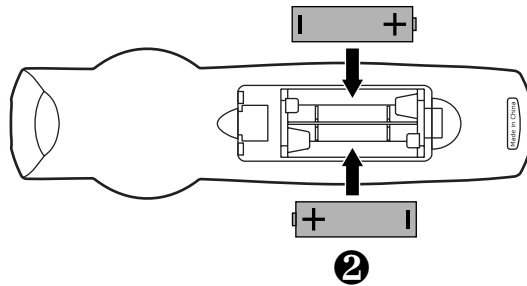
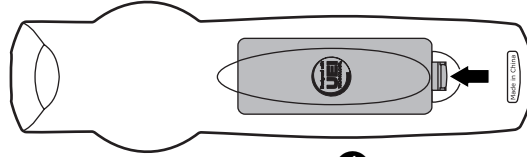

1. On the back of the remote control, push the tab and lift off the battery cover.
2. Locate the two (2) enclosed AA batteries. Match the + and - marks with those in the battery case, then insert them.
3. Align the cover's keys with the case's holes and press the cover back into place. The tab should click when the cover is locked.
4.  Test the remote control by pressing any mode key (e.g., TV). If the batteries are inserted correctly, the LED (red light) will blink once.

NOTE: When batteries need replacement, the remote control will cease to operate. Replace the batteries and the unit will be restored to its full functionality, complete with your favorite settings.

PROGRAMMING DEVICE CONTROL

The Atlas DVR/PVR 5-Device Universal Remote Control is preprogrammed to operate the Scientific Atlanta cable box (converter) provided by your cable system, an RCA TV, a Toshiba DVD player, an RCA VCR (as an AUX device), and a Pioneer audio receiver. To control devices other than the default brands, perform the following steps; otherwise skip this section:

NOTES: For TV/VCR Combo control, skip this section and perform the instructions on page 12. Also refer to the "Device Table" on page 8 to find out which devices can be programmed onto each device key.

If you have another brand of cable converter or a satellite receiver you would like to control, you'll first need to unlock the cable ID Lock before changing the converter code – see "Programming ID Lock" on page 27.

1. Turn on a device and, if applicable, insert video media, (e.g., cassette or disc).

NOTE: Please read steps 2 through 4 completely before proceeding. Highlight or write down the codes and device you wish to program before moving on to step 2.

2. On the remote control, press a device key once (i.e., AUX, DVD, AUD, TV, or CBL); it will blink once. Then press and hold  until the selected mode key blinks twice, then release **SETUP**.

3. Use the *Manufacturer's Codes* (starting on page 13) to locate the the type of device and brand name and then enter the first four-digit code for your device. If performed correctly, the selected mode key will blink twice.

NOTE: If the selected mode key emits a long blink, the entry is invalid. Repeat steps 2 through 3 and try entering the same code again.

4. Aim the remote control at the device and press  once. The device should turn off. If it does not, repeat steps 2 through 3, trying each code for your brand until you find one that works. If it still does not respond, try searching for the code (see *Searching For Your Code* on page 24).

*NOTE: If the device does not have a **POWER** key, press the **▶ (Play)** key.*

5. Repeat steps 1 through 4 for each device you want the remote control to operate. For future reference, write down each working device code in the following boxes:

AUX Code

Device Type: _____

DVD Code

Device Type: _____

AUD Code

Device Type: _____



CBL Code

Device Type: _____

TV Code

PROGRAMMING TV/VCR COMBO CONTROL

If you own a TV/VCR Combo, perform the following instructions to control this device:

1. Turn on your TV/VCR Combo and insert a video cassette.
2.  On the remote control, press **AUX** once; it will blink once. Then press and hold **SETUP** until the **AUX** key blinks twice, then release **SETUP**.

3. Use the *Setup Codes For TV/VCR Combos* (on page 20) to locate the brand name and then enter the first four-digit code for your TV/VCR Combo. If you perform this procedure correctly, the **AUX** key will blink twice.

*NOTE: If the **AUX** key did not blink twice after entering the code's last digit, then repeat steps 2 through 3 and try entering the same code again.*

If you've located a TV/VCR setup code that works for your TV/VCR Combo and a separate TV code is also listed, you'll need to program this code into the remote control to access volume control (see *Programming Device Control* on page 10).

4.  Aim the remote control at your TV/VCR Combo and press **PWR** once. The device should turn off. If it does not respond, repeat steps 2 through 3, trying each code listed for your brand until you find one that works. If it still does not respond, try searching for the code (see *Searching For Your Code* on the page 24).
5. For future reference, write down each working device code in the boxes below:

TV/VCR Code

TV Code (if used)

MANUFACTURER'S CODES

Setup Codes For Audio Amplifiers:

Aiwa	0406
Bose	0674
Carver	0269
Curtis Mathes	0300
Denon	0160
Harman/Kardon	0892
JVC	0331
Left Coast	0892
Linn	0269
Magnavox	0269
Marantz	0269, 0892
Optimus	0300
Panasonic	0308, 0521, 0308
Parasound	0246
Philips	0269, 0892
Pioneer	0013, 0300
Polk Audio	0269, 0892
RCA	0300
Sony	0689
Soundesign	0211
Technics	0308, 0521
Victor	0331
Wards	0013, 0211
Yamaha	0354

Setup Codes For Audio Receivers:

ADC	0531
Adcom	0616
Admiral	0182
Aiwa	1089, 1405, 0158, 1388, 0189, 0121, 0405
Akai	0224, 0076
Alco	1390
Apex Digital	1257
Arcam	1120
Audiotronic	1189
Audiovox	1390
Bose	1229
Capetronic	0531
Carver	1089, 1189, 0189, 0042, 0360, 0008
Casio	0195, 0201
Clarinette	0195
Compaq	1136
Curtis Mathes	0080, 0201
Denon	1104, 1160, 1311, 1360, 0004, 0273, 0771
Emerson	0424, 0255
Fisher	0042, 0360, 0219

continued on next page...

MANUFACTURER'S CODES

Setup Codes For Audio Receivers (continued):

Garrard	0463, 0424, 0146, 0281
Hafler	0146
Harman/Kardon	0110, 0189, 0891
Hewlett Packard	1181
Inkel	0062
JBL	0110, 1306
JVC	0074, 1374, 0464
KLH	1390
Kenwood	1313, 1027, 1570, 1569, 0027, 0186, 0042, 0077, 0313, 0314, 0569, 1051, 1052
Koss	1366, 0424, 0255
LXI	0181
Lexicon	1076
Linn	0189
Lloyd's	0195
Luxman	0166
MCS	0039, 0346, 0201
Magnavox	1089, 1189, 0531, 0189, 0195, 0391, 0128, 0222
Marantz	1089, 1189, 0039, 0189, 0128, 0200, 0006
Modulaire	0195
Musicmagic	1089
NAD	0320
NEC	0235
Nakamichi	0097, 0347
Onkyo	0135, 1298, 0100, 0380, 0119
Optimus	1023, 0531, 0670, 0186, 0080, 0738, 0801, 0042, 0181, 0219, 0177
Panasonic	1518, 0039, 0309, 0367, 0518
Penney	0195, 0201
Philips	1089, 1189, 1269, 0189, 1120, 0391
Pioneer	1023, 0531, 0014, 0150, 0630, 1343, 0080, 0244, 0289
Polk Audio	0189
Proscan	1254
Quasar	0039
RCA	1023, 1254, 1390, 0531, 0080, 0360, 0054, 1154, 0346, 0530
Realistic	0195, 0181, 0163, 0182
Samsung	1295
Sansui	1089, 0189, 0346, 0193
Sanyo	0801, 0219
Scott	0322, 0163
Sears	0201
Semivox	0255
Sharp	0186, 0117
Sherwood	1653, 0491, 0502, 0062
Sonic	0281
Sony	1058, 1158, 1258, 1658, 1758, 0158, 0474, 0168, 1042
Soundesign	0670
Stereophonics	1023

Sunfire	1313, 0313, 0314, 1052
Sylvania	0222
Symphonic	0182
Teac	0463, 0163, 0387
Technics	1308, 1309, 1518, 0039, 0309, 0208, 0518
Techwood	0281
Thorens	1189
Venturer	1390
Victor	0074
Wards	0158, 0014, 0189, 0080, 0054
Yamaha	0176, 1176, 0186, 0081, 0082
Yorx	0195
Zenith	0857, 0281

Setup Codes For Cable Boxes (Converters):

Director	0476
General Instrument	0476
Jerrold	0476
Motorola	0476
Pioneer	1877
Scientific Atlanta	1877

Setup Codes For DVD Players:

Aiwa	0641
Apex Digital	0672, 0794, 0795, 0796, 0797, 0755, 0717
Audiologic	0736
B & K	0655, 0662
Blue Parade	0571
Broksonic	0695
DVD2000	0521
Denon	0490, 0634
Emerson	0591
Enterprise	0591
Fisher	0670
GE	0522, 0815, 0717
GPX	0769, 0699
Go Video	0715, 0783
Gradiente	0651
Greenhill	0717
Harman/Kardon	0582
Hitachi	0573, 0664
Hiteker	0672
JVC	0558, 0623
KLH	0717
Kenwood	0490, 0534, 0682, 0737
Konka	0711, 0719
Koss	0651
Lasonic	0798

continued on next page...

MANUFACTURER'S CODES

Setup Codes For DVD Players (continued):

Magnavox	0503,0675
Marantz	0539
Microsoft	0522
Mintek	0717
Mitsubishi	0521
Nesa	0717
Onkyo	0503,0627
Oritron	0651
Panasonic	0490,0632
Philips	0503,0539,0854
Pioneer	0525,0571,0632
Polk Audio	0539
Princeton	0674
Proscan	0522
RCA	0522,0571,0822,1022,0717
Rotel	0623
Samsung	0573,0820
Sansui	0695
Sanyo	0670
Sharp	0630
Sherwood	0633
Shinsonic	0533
Sony	0533
Sylvania	0675
Technics	0490
Techwood	0692
Theta Digital	0571
Thrustmaster	0498
Toshiba	0503,0695,1045
Tredex	0799,0800
Urban Concepts	0503
XBox	0522
Yamaha	0490,0539,0545
Zenith	0503,0591

Setup Codes For Satellite Receivers:

General Instrument	0869
Motorola	0869
Next Level	0869
RadioShack	0869
Star Choice	0869

Setup Codes For TVs:

A-Mark	0003
AOC	0030, 0019, 0185, 0003, 0052
Abex	0032
Admiral	0093, 0463
Advent	0761
Adventura	0046
Aiko	0092
Aiwa	0701
Akai	0030
Alaron	0179
Ambassador	0177
America Action	0180
Ampro	0751
Anam	0180
Anam National	0055
Apex Digital	0767, 0765
Archer	0003
Audiovox	0451, 0180, 0623, 0092, 0003
Baysonic	0180
Belcor	0019
Bell & Howell	0154, 0016
Bradford	0180
Brockwood	0019
Broksonic	0236, 0463, 0003
CXC	0180
Candle	0030, 0056, 0046, 0186
Carnivale	0030
Carver	0054
Celebrity	0000
Changhong	0765
Cineral	0451, 0092
Citizen	0060, 0030, 0056, 0092, 0039, 0280, 0046, 0186
Clairtone	0185
Concerto	0056
Contec	0180, 0185
Craig	0180
Crosley	0054
Crown	0180, 0039
Curtis Mathes	0047, 0747, 1147, 1347, 0054, 0154, 0451, 0093, 0060, 0030, 0056, 0145, 0016, 0166, 0702, 0466, 0039
Daewoo	0451, 0019, 0623, 0092, 0039
Daytron	0019
Denon	0145
Dumont	0017, 0019
Dwin	0720, 0774
Electroband	0000, 0185
Electrohome	0389
Emerson	0154, 0236, 0463, 0180, 0178, 0179, 0019, 0623, 0177, 0185, 0282, 0039, 0280, 0038
Envision	0030

continued on next page...

MANUFACTURER'S CODES

Setup Codes For TVs (continued):

Fisher	0154,0159
Fujitsu	0179,0683
Funai	0180,0179,0171
Futuretech	0180
GE	0047,0747,1147,1347,0051,0451,0178,0021,0055,0282,0135,0279
Gibraltar	0017,0030,0019
GoldStar	0030,0178,0019,0032
Gradiente	0053,0056
Grunpy	0180,0179
Hallmark	0178
Harley Davidson	0179
Harman/Kardon	0054
Harvard	0180
Havermy	0093
Hitachi	0056,0145,0016,0151,0032,0038,0279
Infinity	0054
Inteq	0017
JBL	0054
JCB	0000
JVC	0053
Janeil	0046
KEC	0180
KTV	0180,0030,0185,0039,0280
Kaypani	0052
Kenwood	0030,0019
Kloss	0046
Konka	0707,0628,0632,0638,0703
LG	0056
LXI	0047,0747,0054,0154,0156,0178
Logik	0016
Luxman	0056
MEI	0185
MGA	0150,0030,0178,0019
MTC	0060,0030,0056,0019,0185
Magnavox	0054,1254,1454,0030,0179,0187,0096,0020,0186,0386
Majestic	0016
Marantz	0054,0030
Matsushita	0250
Megatron	0178,0145,0003
Memorex	0154,0250,0463,0150,0178,0179,0016
Midland	0047,0747,0017,0051,0135,0039,0032
Minutz	0021
Mitsubishi	0093,0150,0178,0019
Motorola	0093,0055
Multitech	0180
NAD	0156,0178,0166
NEC	0030,0056,0019,0497

NTC	0092
Nikko	0030, 0178, 0092
Noshi	0018
Onwa	0180
Optimus	0154, 0250, 0166
Optonica	0093, 0165
Orion	0236, 0463, 0179
Panasonic	0051, 0250, 0055
Penney	0047, 0747, 1347, 0156, 0051, 0060, 0030, 0178, 0021, 0019, 0018, 0135, 0039, 0003, 0032
Philco	0054, 0463, 0030, 0145, 0019, 0096, 0020
Philips	0054, 1454
Pilot	0030, 0019, 0039
Pioneer	0166, 0679, 0038
Portland	0019, 0092, 0039
Princeton	0717
Prism	0051
Proscan	0047, 0747
Proton	0178, 0466, 0003, 0052
Pulsar	0017, 0019
Quasar	0051, 0250, 0055, 0165
RCA	0047, 0747, 1047, 1147, 1247, 1347, 1447, 0090, 0019, 0679, 0018, 0135, 0038
RadioShack	0047, 0747, 0154, 0180, 0030, 0178, 0056, 0019, 0165, 0039, 0032
Realistic	0154, 0180, 0030, 0178, 0056, 0019, 0165, 0039, 0032
Rhapsody	0185
Runco	0017, 0030, 0603, 0497
SSS	0180, 0019
Sampo	0030, 0039, 0052, 0032
Samsung	0060, 0030, 0178, 0766, 0056, 0019, 0702, 0032
Samsux	0039
Sansei	0451
Sansui	0463
Sanyo	0154, 0159, 0146
Scimitsu	0019
Scotch	0178
Scott	0236, 0180, 0178, 0179, 0019
Sears	0047, 0747, 0054, 0154, 0156, 0178, 0179, 0056, 0171, 0159, 0146
Semivox	0180
Semp	0156
Sharp	0093, 0688, 0689, 0165, 0039, 0386
Shogun	0019
Signature	0016
Simpson	0187, 0186
Sony	0000, 1100
Soundesign	0180, 0178, 0179, 0186
Spectricon	0003
Squareview	0171
Starlite	0180
Supre-Macy	0046

continued on next page...

MANUFACTURER'S CODES

Setup Codes For TVs (continued):

Supreme	0000
Sylvania	0054, 0030, 0171, 0096, 0020
Symphonic	0180, 0171
TMK	0178, 0056, 0177
TNCi	0017
Tandy	0093
Tatung	0055, 0003
Technics	0051, 0250
Technol Ace	0179
Techwood	0051, 0056, 0003
Teknika	0054, 0180, 0150, 0060, 0179, 0056, 0019, 0016, 0092, 0039, 0186
Telefunken	0056, 0702
Toshiba	0154, 0156, 1356, 0060, 1256
Tosonic	0185
Totevision	0039
Vector Research	0030
Victor	0053
Vidikron	0054
Vidtech	0178, 0019
Viking	0046
Wards	0054, 0030, 0178, 0021, 0179, 0056, 0019, 0016, 0165, 0096, 0020
Waycon	0156
White Westinghouse	0463, 0623
Yamaha	0030, 0019, 0769
Zenith	0017, 0463, 0016, 0092
Zonda	0003

Setup Codes For TV/VCR Combos:

Broksonic	0002, 0479 (for TV use 0463)
Citizen	0278
Colt	0072
Curtis Mathes	0035 (for TV use 0051)
Daewoo	0278 (for TV use 0624)
Emerson	0002, 0278 (for TV use 0624), 0479 (for TV use 0463)
Funai	0000
GE	0035 (for TV use 0051), 0048 (for TV use 0093), 0060 (for TV use 0047), 0240
GoldStar	0037 (for TV use 0056)
Harley Davidson	0000
Hitachi	0000
Lloyd's	0000
Magnasonic	0278
Magnavox	0000, 0081 (for TV use 0054)
Magnin	0240
Memorex	0037, 0162 (for TV use 0250), 1162

MGA	0240
Mitsubishi	0048 (for TV use 0093)
Optimus	0162 (for TV use 0250), 1162, 1262
Orion	0002, 0479 (for TV use 0463)
Panasonic	0035 (for TV use 0051), 0162 (for TV use 0250), 1162
Penney	0035 (for TV use 0051), 0037 (for TV use 0056), 0240
Quasar	0035 (for TV use 0051), 0162 (for TV use 0250)
RCA	0035 (for TV use 0051), 0048 (for TV use 0093), 0060 (for TV use 0047), 0240
Sansui	0000, 0479 (for TV use 0463)
Sanyo	0240
Sears	0000, 0037 (for TV use 0056)
Sharp	0048 (for TV use 0093)
Sony	0000, 0032 (for TV use 0000)
Sylvania	0081 (for TV use 0054)
Symphonic	0000, 0563
Thomas	0000
White Westinghouse	0278 (for TV use 0624)
Zenith	0000

Setup Codes For VCRs And PVRs:

Admiral	0048, 0209
Adventura	0000
Aiko	0278
Aiwa	0037, 0000, 0307
Akai	0041, 0106, 0061
America Action	0278
American High	0035
Asha	0240
Audiovox	0037, 0278
Beaumarck	0240
Bell & Howell	0104
Broksonic	0184, 1479, 0121, 0209, 0002, 0479, 0295, 0361
CCE	0072, 0278
Calix	0037
Canon	0035
Capehart	0020
Carver	0081
Cineral	0278
Citizen	0037, 1278, 0278
Colt	0072
Craig	0037, 0047, 0240, 0072, 0271
Curtis Mathes	0035, 0060, 0760, 0162, 1035, 0041
Cybernex	0240
Daewoo	0045, 1278, 0278, 0020, 0561
Daytron	0020
Denon	0042
Dynatech	0000
Electrohome	0037
Electroponic	0037

continued on next page...

MANUFACTURER'S CODES

Setup Codes For VCRs And PVRs (continued):

Emerex	0032
Emerson	0037, 0184, 0000, 1479, 1278, 0121, 0043, 0209, 0002, 0278, 0479, 0561, 0061, 0208, 0036, 0295, 0361, 0294
Fisher	0047, 0104, 0054
Fuji	0035, 0033
Funai	0000
GE	0035, 0060, 0760, 1035, 1060, 0240, 0807, 0202, 0761
Garrard	0000
Go Video	0432, 0526, 0643
GoldStar	0037, 1237, 0038
Gradiente	0000, 0008
HI-Q	0047
Harley Davidson	0000
Harman/Kardon	0081, 0038
Harwood	0072
Headquarter	0046
Hitachi	0000, 0042, 0041, 0105
Hughes Net. Sys.	0042
JVC	0067, 0041, 0008
Jensen	0041
KEC	0037, 0278
KLH	0072
Keen	0693
Kenwood	0067, 0041, 0038
Kodak	0035, 0037
LXI	0037
Lloyd's	0000, 0208
Logik	0072
MEI	0035
MGA	0240, 0043, 0061
MGN Technology	0240
MTC	0000, 0240
Magnasonic	1278
Magnavox	0035, 0039, 0081, 0563, 0000, 1781, 0149
Magnin	0240
Marantz	0035, 0081
Marta	0037
Matsushita	0035, 0162, 0454
Memorex	0035, 0037, 1037, 0048, 0039, 0047, 0162, 1162, 1262, 0000, 1237, 0240, 0104, 0209, 0454, 0479, 0046, 0307
Minolta	0042, 0105
Mitsubishi	0067, 0807, 0043, 0061
Motorola	0035, 0048
Multitech	0000, 0072
NEC	0067, 0104, 0041, 0038, 0040
Nikko	0037
Nikon	0034
Noblex	0240

Olympus	0035
Optimus	0037, 0048, 1048, 0162, 1062, 1162, 1262, 0104, 0454, 0432
Optonica	0062
Orion	0184, 1479, 0209, 0002, 0479, 0295
Panasonic	0035, 0225, 0162, 1062, 1162, 1262, 0616, 1035, 0454
Penney	0035, 0037, 0042, 1237, 1035, 0240, 0038, 0054, 0040
Pentax	0042, 0105
Philco	0035, 0209, 0479
Philips	0035, 0081, 1081, 1181, 0618, 0062
Pilot	0037
Pioneer	0067
Polk Audio	0081
Portland	0020
Profitronic	0240
Proscan	0060, 0760, 1060, 0202, 0761
Protec	0072
Pulsar	0039
Quarter	0046
Quartz	0046
Quasar	0035, 0162, 1162, 1035, 0454
RCA	0060, 0760, 0042, 1035, 1060, 0240, 0807, 0149, 0106, 0202, 0761, 0105
RadioShack	1037, 0000
Radix	0037
Randex	0037
Realistic	0035, 0037, 0048, 0047, 0000, 0104, 0046, 0062
ReplayTV	0614, 0616
Ricoh	0034
Runco	0039
STS	0042
Samsung	0045, 0240
Samtron	0643
Sanky	0048, 0039
Sansui	0000, 0067, 1479, 0209, 0041, 0479, 0271
Sanyo	0047, 0240, 0104, 0046
Scott	0184, 0045, 0121, 0043
Sears	0035, 0037, 0047, 0000, 0042, 1237, 0104, 0046, 0105, 0054
Semp	0045
Sharp	0048, 0848, 0807, 0062, 0738
Shintom	0072
Shogun	0240
Singer	0072
Sonic Blue	0614, 0616
Sony	0035, 0032, 1032, 0000, 0636, 0033, 1232, 0034
Sylvania	0035, 0081, 0000, 1781, 0043
Symphonic	0000
TMK	0240, 0208, 0036
Tatung	0041
Teac	0000, 0041
Technics	0035, 0162
Teknika	0035, 0037, 0000

continued on next page...

MANUFACTURER'S CODES







Setup Codes For VCRs And PVRs (continued):

Thomas	0000
Tivo	0618, 0636
Toshiba	0045, 0845, 0043
Totevision	0037, 0240
Unitech	0240
Vector	0045
Vector Research	0038, 0040
Video Concepts	0045, 0061, 0040
Videomagic	0037
Videosonic	0240
Villain	0000
Wards	0035, 0060, 0760, 0048, 0047, 0081, 0000, 0042, 0240, 0072, 0149, 0062
White Westinghouse	1278, 0209, 0072
XR-1000	0035, 0000, 0072
Yamaha	0038
Zenith	0039, 0000, 0033, 1479, 0209, 0479, 0034, 0637

SEARCHING FOR YOUR CODE

If your home entertainment device does not respond to the Atlas DVR/PVR 5-Device Universal Remote Control after trying all of the codes listed for your brand, or if your brand is not listed at all, try searching for your code.

For example, to search for a code for your TV:

1. Turn on your TV.
2.  On the remote control, press TV once; it will blink once. Then press and hold SETUP until the TV key blinks twice, then release SETUP.

3.  Enter 9 - 9 - 1. The TV key will blink twice.

4.  Aim the remote control at the TV and slowly alternate between pressing PWR and TV. Stop when the TV turns off.







NOTE: In the search mode, the remote control will send IR codes from its library to the selected device, starting with the most popular code first.

5.  Press **SETUP** once to lock in the code. The TV key will blink twice.
6. To search for the codes of your other devices, repeat steps 1 through 5, but substitute the appropriate key (e.g., **AUX**, **DVD**, **AUD**, or **CBL**) for the device you are searching for.



CHECKING THE CODES

If you have set up the Atlas DVR/PVR 5-Device Universal Remote Control using the *Searching For Your Code* procedure (on the previous page), you may need to find out which four-digit code is operating your equipment.

For example, to find out which code is operating your TV:

1.  On the remote control, press **TV** once; it will blink once. Then press and hold **SETUP** until the TV key blinks twice, then release **SETUP**.

2.  Enter **9 - 9 - 0**. The TV key will blink twice.

3.  To view the code for the first digit, press **1** once. Wait 3 seconds and count the number of times the TV key blinks (e.g., 3 blinks = 3) and write down the number in the leftmost TV Code box on page 11.

NOTE: If a code digit is "0", the selected mode key will not blink.







4.  Repeat step 3 three more times for the remaining digits. Use **2** for the second digit, **3** for the third digit, and **4** for the fourth digit. Finish writing down the code in the TV Code boxes on page 11.

5. To check for other device codes, repeat steps 1 through 4, but substitute the appropriate key (e.g., **AUX**, **DVD**, **AUD**, or **CBL**) for the device you are checking. Write down the codes in the appropriate boxes on page 11.

PROGRAMMING CHANNEL CONTROL LOCK







By default, the remote control's channel-control capabilities are locked to the cable converter. The affected keys* are 0 ~ 9, CH+, CH-, ENTER, and LAST. This will guarantee that you do not inadvertently change a channel on your TV or VCR. However, you can de-activate this feature to allow full access to these keys in the TV and VCR modes.

*NOTE: This feature does not affect the **AUD** mode.

To De-Activate Channel Control Lock:











1.  On the remote control, press CBL once; it will blink once. Then press and hold  until the CBL key blinks twice, then release SETUP.
2.  Enter 9 - 7 - 3. The CBL key will blink twice.

3.  Press CH- once. The CBL key will blink four times.
4. Now, the remote control will provide TV and VCR channel-control capabilities while in the TV or VCR mode.

To Re-Activate Channel Control Lock:

1.  On the remote control, press CBL once; it will blink once. Then press and hold  until the CBL key blinks twice, then release SETUP.
2.  Enter 9 - 7 - 3. The CBL key will blink twice.

3.  Press CH+ once. The CBL key will blink twice.
4. Now, regardless of what mode you select (except AUD), only the channel control capability of your cable converter will be accessible.

PROGRAMMING ID LOCK

The Atlas DVR/PVR 5-Device Universal Remote Control is locked at the factory to operate a Scientific Atlanta cable converter. However, if you have another brand or model of cable converter or satellite service that you would like to control, then you'll need to perform the following steps to unlock the *ID Lock*, enter in a new manufacturer's code, and lock the *ID Lock* again.

1. Turn on the cable converter.
2.  On the remote control, press CBL once; it will blink once. Then press and hold  until the CBL key blinks twice, then release SETUP.
3.  Enter 9 -  8 -  2. The CBL key will blink four times, indicating *ID Lock* is unlocked.
4. Perform the instructions in *Programming Device Control* on page 10 to program device control for the desired cable converter or satellite receiver. Upon completion, perform the remaining steps (5 and 6 on this page) to again lock the *ID Lock*.
5.  On the remote control, press CBL once; it will blink once. Then press and hold  until the CBL key blinks twice, then release SETUP.
6.  Enter 9 -  8 -  2. The CBL key will blink twice, indicating *ID Lock* is again locked.



PROGRAMMING "TUNE-IN" KEYS FOR SPECIFIC CHANNELS

The Atlas DVR/PVR 5-Device Universal Remote Control includes three "Tune-In" keys (located directly below the MUTE and LAST keys). Each can be programmed to remember three of your favorite cable channel settings for a total of nine channels. If you want to change the cable channels in a previously-programmed "Tune-In" key, you'll need to clear the key first (see next page).

continued on next page...

PROGRAMMING "TUNE-IN" KEYS FOR SPECIFIC CHANNELS (continued)

To Program A "Tune-In" Key:

1.  On the remote control, press CBL once; it will blink once. Then press and hold  until the CBL key blinks twice, then release SETUP.

2.  Enter 9 - 9 - 5. The CBL key will blink twice. Then select a "Tune-In" key and press it once.

3.  Press CBL once followed by the channel number to be programmed (e.g., 3 - 9).



NOTE: If you are programming a channel for a Digital Cable Converter, you need to enter all channels in a 3-digit channel format. For example, if the desired channel is 39, then enter it as 0 - 3 - 9.

4.  Press and hold SETUP until the CBL key blinks twice, then release SETUP.

5. To add another channel, repeat steps 1 through 4, substituting the new channel to be added in step 3.

NOTE: Programming more than three channels on the same "Tune-In" key will overwrite previous settings.

To Clear A "Tune-In" Key:

1.  On the remote control, press CBL once; it will blink once. Then press and hold  until the CBL key blinks twice, then release SETUP.

2.  Enter 9 - 9 - 5. The CBL key will blink twice. Then select a "Tune-In" key you want to clear and press it once.







3.  Press and hold SETUP until the CBL key blinks twice, then release SETUP.

4. This "Tune-In" key is now clear and ready for reprogramming (see above – To Program A "Tune-In" Key). If desired, repeat steps 1 through 3 in this section to clear another "Tune-In" key.

USING THE MASTER POWER KEY

The Atlas DVR/PVR 5-Device Universal Remote Control has a unique feature that allows you to sequentially turn on or off up to five of your home entertainment devices with a single key press.

To Program The Master Power Key:

1.  On the remote control, press and hold **SETUP** until the last-selected device key blinks twice, then release **SETUP**.
2.  Enter **9 - 9 - 5**. The last-selected device key will blink twice. Then press **PWR** once.

3.  For the first device you want in the *power on* sequence, press a device key (e.g., **CBL**) once .
4. Repeat step 3 up to four more times to add the second, third, fourth, and fifth device, as desired.
5.  To save the settings and exit the program, press and hold **SETUP** until the last-selected device key blinks twice, then release **SETUP**.

To Operate The Master Power Key:

*NOTE: If **MASTER POWER** is not programmed, pressing it will only command the last-selected device to power on or off.*

1. After programming, point the remote control at the devices.
2.  Press and hold **PWR** for at least 2 seconds. You will see the devices power on or off according to the programmed sequence.







To Clear The Master Power Key:

1. Perform steps 1 and 2 in the first section above, *To Program The Master Power Key*.
2.  To clear the settings and exit the program, press and hold **SETUP** until the last-selected device key blinks twice, then release **SETUP**.

RE-ASSIGNING DEVICE KEYS

The Atlas DVR/PVR 5-Device Universal Remote Control can be set up to control a second device. For example, to have the unit control a TV, a Cable Converter, and *two* DVD Players, you will need to re-assign the unused AUX key to operate the second DVD Player as follows:

NOTE: AUX is preset at the factory to control an RCA VCR. Performing the below steps will overwrite those settings.

1.  On the remote control, press AUX once; it will blink once. Then press and hold SETUP until the AUX key blinks twice, then release SETUP.

2.  Enter 9 - 9 - 2. The AUX key will blink twice.

3.  Press DVD once, then press AUX once. The AUX key will blink twice.

4. The AUX key is now ready to be programmed for your second DVD player. See *Programming Device Control* on page 10.

To re-assign other device keys, repeat steps 1 to 4 and substitute the key sequence using the following chart:

NOTE: Only one device can be assigned to an unused device key at a time.

To Re-Assign	Perform Key Sequence
AUX as 2nd AUD key:	AUX - SETUP - 9 - 9 - 2 - AUD - AUX
AUX as 2nd TV key:	AUX - SETUP - 9 - 9 - 2 - TV - AUX
AUX as 2nd CBL key:	AUX - SETUP - 9 - 9 - 2 - CBL - AUX
AUX back to AUX:	AUX - SETUP - 9 - 9 - 2 - AUX - AUX

To re-assign another unused device key, substitute it for the AUX key above and then perform the sequence. For example, to re-assign an unused AUD key as a second DVD key, perform AUD - SETUP - 9 - 9 - 2 - DVD - AUD.







When a re-assignment is done, the selected device key (e.g., AUD) will blink twice to confirm your choice. At that time, you will need to program device control (see *Programming Device Control* on page 10).

CHANGING VOLUME LOCK

On this remote control, *Global Volume Lock* is set to TV, so you can control TV volume while in the **AUX**, **DVD**, **TV** or **CBL** mode. If desired, you can still perform *Individual Volume Unlock* on a selected device to set its volume control for independent operation.





*NOTE: The audio mode's volume controls are active regardless of Volume Lock settings. However, if you lock the volume controls to the **AUD** mode, you will have control of the audio device's volume in all other modes (i.e., **AUX**, **DVD**, **TV**, and **CBL**).*

To Unlock Volume Control For A Single Device (Individual Volume Unlock):

1.  Assuming *Global Volume Lock* is active, select a mode on the remote control that you want to unlock (e.g., **CBL**) and press it once. Next, press and hold **SETUP** until the device key blinks twice, then release **SETUP**.

2.  Enter 9 - 9 - 3. The last-selected device key will blink twice.

3.  Press **VOL-** once. The last-selected device key will blink four times.
4. Repeat steps 1 through 3 (of this section) for each device you want volume to be unlocked.
5. Now, after you select a device that has volume unlocked (e.g., **CBL**), pressing **VOL+**, **VOL-**, or **MUTE**, will control the device's volume only in its own mode.

To Unlock All Volume Control (Global Volume Unlock):

NOTE: Performing these instructions will set independent volume control for all programmed devices.





1.  On the remote control, press and hold **SETUP** until the last-selected device key blinks twice, then release **SETUP**.
2.  Enter 9 - 9 - 3. The last-selected device key will blink twice.

3.  Press **VOL+** once. The last-selected device key will blink four times.

continued on next page...

CHANGING VOLUME LOCK (continued)

To Lock Volume Control To One Mode (Global Volume Lock):

*NOTE: The audio mode's volume controls are active regardless of Volume Lock settings. However, if you lock the volume controls to the **AUD** mode, you will have control of the audio device's volume in all other modes (i.e., **AUX**, **DVD**, **TV**, and **CBL**).*

1.  On the remote control, press and hold **SETUP** until the last-selected device key blinks twice, then release **SETUP**.
2.  Enter **9 - 9 - 3**. The last-selected device key will blink twice.

3.  Select a mode (e.g., **TV**) where you want to globally lock the volume controls. The selected device key will blink twice.
4. Now, when you press **VOL+**, **VOL-**, or **MUTE**, the volume of the selected device (e.g., **TV**) can be controlled regardless of mode.

TROUBLESHOOTING

PROBLEM: Device key does not blink when you press a key.

SOLUTION: Replace the batteries with two (2) new AA alkaline batteries (see page 9).

PROBLEM: Device key blinks when you press a key, but home entertainment device does not respond.

SOLUTION: Make sure you are aiming the remote control at your home entertainment device and that you are within 15 feet of the device you are trying to control.

PROBLEM: The remote control does not control home entertainment devices or commands are not performing properly.

SOLUTION: Try all listed codes for the device brand being set up. Make sure all devices can be operated with an infrared remote control.

PROBLEM: TV/VCR Combo does not respond properly.

SOLUTION: Use the VCR codes for your brand. Some combo units may require both a TV code and a VCR code for full operation (see page 12).

PROBLEM: No volume on a second TV.

SOLUTION: Follow instructions in *Changing Volume Lock* (see page 31).

PROBLEM: CH+, CH-, and LAST do not work for your RCA TV.

SOLUTION: Due to RCA design (1983-1987), only the original remote control will operate these functions.

PROBLEM: Tried "Search Method" and still could not find a working code.

SOLUTION: Try the "Search Method" again after clearing out the device key as follows: Press and hold SETUP until device key blinks twice, then release. Next enter 9 - 9 - 2. Then press and release the device key to be cleared twice.

PROBLEM: Remote control does not turn on Sony or Sharp TV/VCR Combo.

SOLUTION: For power on, these products require programming TV codes on the remote control. For Sony, use TV code 0000 and VCR code 0032. For Sharp, use TV code 0093 and VCR code 0048.

INSTRUCTIONS TO THE USER

This equipment has been tested and found to comply with the limits for a class B digital device, pursuant to part 15 of the FCC Rules. These limits are designed to provide reasonable protection against harmful interference in a residential installation. This equipment generates, uses and can radiate radio frequency energy and if not installed and used in accordance with the instructions, may cause harmful interference to radio communications.

However, there is no guarantee that interference will not occur in a particular installation. If this equipment does cause harmful interference to radio or television reception, which can be determined by turning the equipment off and on, the user is encouraged to try to correct the interference by one or more of the following measures:

- Reorient or relocate the receiving antenna.
- Increase the separation between the equipment and receiver.
- Connect the equipment into an outlet on a circuit different from that to which the receiver is connected.
- Consult the dealer or an experienced radio/TV technician for help.

This equipment has been verified to comply with the limits for a class B computing device, pursuant to FCC Rules. In order to maintain compliance with FCC regulations, shielded cables must be used with this equipment. Operation with non-approved equipment or unshielded cables is likely to result in interference to radio and TV reception. The user is cautioned that changes and modifications made to the equipment without the approval of manufacturer could void the user's authority to operate this equipment.

ADDITIONAL INFORMATION

This product does not have any user-serviceable parts. Opening the case, except for the battery cover, may cause permanent damage to your Atlas DVR/PVR 5-Device Universal Remote Control.

Copyright 2003 by Universal Electronics Inc. No part of this publication may be reproduced, transmitted, transcribed, stored in any retrieval system, or translated to any language, in any form or by any means, electronic, mechanical, magnetic, optical, manual, or otherwise, without prior written permission of Universal Electronics Inc.

M1054

03/03

