

# Table of Contents

Before You Begin	
Chapter One -----	Page 1.1
Installing the Hardware	
Chapter Two -----	Page 2.1
Important Concepts	
Chapter Three -----	Page 3.1
Installing the Software	
Chapter Four -----	Page 4.1
Booting the Trackstar System	
Chapter Five -----	Page 5.1
Diskettes in Detail	
Chapter Six -----	Page 6.1
Features & Functions	
Chapter Seven -----	Page 7.1
File Transfer	
Chapter Eight -----	Page 8.1
Installation	
Appendix A -----	Page A - 1

## Chapter One

### **Before You Begin**

How to use this manual

The Tutorial Section:

Beginning with Chapter Two, The first section of this Manual will

lead you step-by-step through the installation and operation of your Trackstar E. By the end of Chapter Five you will have installed the Trackstar in your IBM or compatible configured the board for your particular system, and run your first Apple program. Along the way you will have learned how you can use the special

Apple keys from the PC keyboard and how to switch between the Apple and MS DOS systems at will. You will also have learned about the two major Apple operating systems, DOS 3.3 and ProDOS, and how to correctly configure your Trackstar to run programs from each.

The Reference Section:

Chapters Six through eight will cover aspects of the Trackstar system in more depth. They will explain how to copy Apple programs onto your MS-DOS 5.25 diskettes, 3.5' diskettes, network, or hard disk drive, how to use your printer with Apple software, and how to transfer text or data between your MSDOS and Apple systems.

One convention used throughout this manual is the use of < > characters to denote a particular key on the keyboard. The statement "Press the <esc>key now" refers to one particular key on the keyboard labelled ESC. You should not type the individual letters E S C.

*Throughout the manual, you will find useful or interesting information set off in italics.*

Your Trackstar E is an entire computer system and you may not find it as easy to install as the typical peripheral card. The installation is straightforward and carefully documented. Join with us through the first five chapters and we will have you up and running with a minimum of frustration.

## Technical Overview:

The Trackstar E is a 65C02 Parallel Processor board. It may be installed into any IBM PC, xi; AT, 386 or compatible, and will provide you with the ability to run Apple software on those machines. The Trackstar E supports most Apple features and contains enhancements not present on the original Apple systems

Your Trackstar E comes standard with the following features:

- 65C02 Microprocessor
- 128K Main Memory
- 40 & 80 Column Text
- Apple LoRes, HiRes, and Double High Res Graphics
- Supports up to four disk drives
- Supports a hard disk drive
- Supports Local Area Networks .
- Supports standard Serial and Parallel ports
- Apple compatible 5.25" disk drive port
- Apple//c compatible game port
- Thunderclock compatible Apple clock.

## Equipment included .

Before beginning the installation, please take a moment to review the enclosed parts list and verify that everything you need was included with your Trackstar E. If anything is missing, do not attempt to install the product. Contact your Dealer or Diamond Computer Systems for assistance.

## Copying the Trackstar Utility Diskette

Before you proceed you should make one or more backup copies of your Trackstar Utility Disk. Complete instructions for duplicating diskettes is given In your MS DOS operating manual. A brief summary of the procedure is given below:

First, place your MS DOS **System DISK** in drive A: and a **blank** diskette in drive B:.

At the A> prompt type: "**FORMAT B:** <enter>". This will format the diskette in drive **B:** as an MS DOS data diskette.

Now, remove the MS DOS SYSTEM DISK from drive A: and insert

the TRACKSTAR UTILITY DISK. Type "**COPY A:."** **B:** <enter>".  
All of the files on drive A: will be duplicated onto the diskette now  
in drive B>

You have created a duplicate copy of the Trackstar Utility Diskette.

*At this time please place the original Trackstar Utility Diskette in a safe place. It should only be used again if the copy becomes damaged or otherwise unusable.*

---

## Chapter Two

# Installing the Hardware

### Preparing your Workspace

Take this moment to assemble the tools you will need. The Owners Manual for your computer will describe what tools you will need to open the case before installing the Trackstar E. In addition you will need a soft cloth on which to **Set** the computer and enough extra space to set this manual beside it,

The Trackstar E can be used in any PC, XT, AT, 386 or compatible computer.

At this time, please turn to Appendix A to begin installation of the hardware.

When you have completely installed the hardware, please turn to Chapter Three to begin installation of the software.

**TURN TO APPENDIX A NOW**

---

## Chapter Three

### Important Concepts

#### Before Configuring your System

There are three concepts crucial to the successful installation of the Trackstar. These concepts relate to how the Trackstar System uses the hardware of your MS DOS computer while running Apple software, particularly with respect to the disk drives. The Trackstar has several unique disk features that make the system much more powerful than the standard Apple //e.

The three areas that we will cover in this chapter are Software Compatibility, Storing Apple programs under MS DOS, and the proper use of your MS DOS disk drives while in Trackstar mode.

This section will provide you with a necessary overview before you configure the system in Chapter Four. Each of the concepts explained here will be covered in more detail later in the manual.

#### Software Compatibility

Software compatibility is quite important to getting the most out of your Trackstar System.

The Trackstar system may be initialized to one of two compatibility levels; **standard** Compatibility or **high** Compatibility.

Look at the diagram in Figure 1.

You will see that your Trackstar system can be configured in one of three possible ways; one in standard compatibility and two in high compatibility. All compatibility modes relate to the particular version of the BASIC language that is stored in the Trackstar.

#### Standard Compatibility

The Trackstar comes equipped with a version of the BASIC language written by Language Arts, Inc. This BASIC is very similar to but not identical with that supplied by Apple Computer. As a result, most Apple programs, but not all, will run. When using the built in Language Arts BASIC; you will be in the standard compatibility mode.

### Trackstar System Memory

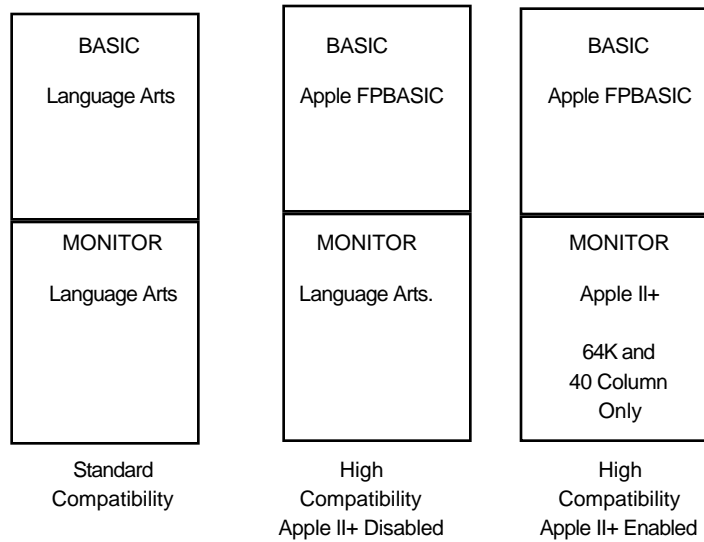

Figure 3-1

### High Compatibility

Certain programs require the use of Apple's version of BASIC in order to run correctly. A copy of this BASIC, called FPBASIC, is contained on the APPLE DOS 3.3 MASTER diskette. It is not included with the Trackstar product and must be supplied by the user. FPBASIC can be loaded into the Trackstar system at startup time. When this version of BASIC is loaded you are in high compatibility mode.

### About Apple Diskettes and Trackstar

*Any program that runs in standard compatibility mode will also run in high compatibility.*

If you have a copy of Apple FPBASIC you might prefer to use High Compatibility mode.

The Apple programs that you will be using are provided on standard 5.25" floppy diskettes. These diskettes can only be read from an Apple compatible or MS DOS 360K disk drive. The Trackstar System comes equipped with an Apple compatible diskdrive port for just this purpose.

Your Trackstar also has another method for storing Apple programs. This other method, called Trackstore, allows Apple software to be placed on an MS DOS hard disk, a floppy disk drive, a network file server, or any other MS DOS volume.

The Trackstore concept allows you to create MS DOS files large enough to hold the entire contents of an Apple floppy disk. You can then copy programs from Apple diskettes into these MS DOS files.

This MS DOS file (or Trackstore diskette) can now be used exactly as if it were an actual Apple floppy disk. You can boot from a Trackstar disk, you can save data on a Trackstore disk, you can create and initialize blank TrackStore disks. As far as the Trackstar is concerned Trackstar disk IS an Apple floppy diskette. TrackStore diskettes are explained in greater detail in Chapter Six.

Remember: Actual Apple diskettes can only be read or written using an External Apple disk drive or a compatible MS DOS 360K drive.

Trackstore diskettes are MS DOS files that contain within them the contents of an Apple diskette. Trackstore diskettes can be kept on any MS DOS volume.

Within the Trackstar system, any menu that requires selection of a diskette will indicate if an Apple or Trackstore diskette is expected.

### Assigning Apple Disk Drives in an MS DOS Machine

An Apple //e computer typically has two 5.25" floppy disk drives attached to it. One of these drives, the boot drive, is identified by the Apple as being in SLOT6, D1. This drive is the one from which Apple programs are first started or booted".

The other drive is identified as SLOT 6, D2, This drive, the data drive, is used to read data and program diskettes.

Your Trackstar system can read and write programs from up to four "Apple disk drives".

Your Trackstar System can have, at the most, one actual Apple disk drive attached. However, it can be told to use your MS DOS disk drives as if they were Apple drives. This is what you will do during the configuration process.



As was mentioned above, 211 Apple // software comes on 5.25 disks. When you configure the system, especially as a first time user, you will want your Apple boot drive (SLOT 6, D1) to be one capable of reading these Apple diskettes. This means that the drive associated with SLOT6, D1 must be either an External Apple drive or a compatible 360K MS DOS disk drive.

Drive two (SLOT 6, D2) can be an Apple floppy disk or any MS DOS volume. It will use either Apple diskettes or TrackStore media depending on the type of drive selected.

These two disk drives can be used with any Apple operating system; DOS, ProDOS, or PASCAL.

### Apple ProDOS and Large Disk Drives

The last two drives that can be configured to your Trackstar system are for the use of ProDOS only. These drives are assigned as Apple drives SLOT 7, D1 and SLOT 7, D2. They are similar in concept to 140K Trackstore diskettes except that they can be configured as large volumes. These Apple drives can be assigned to any MS DOS volume using the configuration program **TSUTILITY**. They can be any one of the following sizes up to the limit of free space on the MS DOS disk: 360K, 720K, 1Mb, 2Mb, 5Mb, or 10Mb. A SLOT 7 drive would usually be assigned to an MS DOS hard disk or network.

If you have assigned a SLOT 7 drive you will be offered the choice of booting from SLOT 6, D1 or SLOT 7, D1 when the Trackstar is initialized.

### TrackStore and 360K disk drives

TrackStore disks will be covered again in Chapter Six but there is one point that needs to be mentioned here. 360K MS DOS, disk drives are unique in the Trackstar system in that they can read both actual Apple diskettes and TrackStore media. They cannot, however, read both at the same time. If you have configured one of your 360K drives to read Apple software you will be unable to read TrackStore files from that drive. The reverse is also true, a 360K drive configured to use TrackStore diskettes will not be able to read actual Apple diskettes unless it is re-configured.

The configuration of your disk drives under the Trackstar system applies only to their use with Trackstar. The operation of your drives under MS-DOS will be unchanged.

## Automatic loading of FPBASIC

At the beginning of this chapter the subject of standard and high compatibility was discussed. If you wish to run the Trackstar system in high compatibility, then **FPBASIC** must be loaded into the system when Trackstar is initialized.

During the configuration process you will be asked which disk drive you wish to load **FPBASIC** from. If you specify any floppy disk drive, containing either TrackStar,~ or Apple media, you will be prompted to insert a diskette containing **FPBASIC** into that drive when the 'Trackstar is initialized.

**FPBASIC** will load without prompting from a TrackStore diskette named **INIT** if it is on the same Ms-Dos volume as the **STARCOM** program.

**FPBASIC** will also load without prompting from a hard disk or network.

**If** **FPBASIC** is present on a TrackStore diskette, the name of that TrackStore diskette must be **INIT** for automatic loading to take place.

---

## Chapter Four

# Installing the Software.

### Configuring the Utility Diskette

There is one last step to perform before you can run your first Apple program. The Trackstar must be configured to recognize the peripherals attached to your machine.

This program is largely self-explanatory. The illustrations will provide a guide to the general flow of the Configuration Utility. Refer to the text for guidance and suggestions on each section~

The configuration program for the Trackstar system is called **TSUTILITY.COM**. If you copied the Trackstar Utility diskette as described in Chapter One then a copy of this program is on the new Trackstar Utility Diskette still in drive B. If you have not copied the Track star Utility diskette it is suggested that you do so now. Then, insert the copy into your MS-DOS drive and type "**TSUTILITY** <enter>".

You should now see the screen in Figure 4-1.

A screenshot of a text-based menu for the Trackstar-E Utility Program. The text is displayed in a monospaced font on a light background. The menu is enclosed in a rounded rectangular border. At the top, it reads '\*\*\* TRACKSTAR-E Utility Program Version 1.1 \*\*\*'. Below this is the copyright information: '(c) Diamond Computer Systems, Inc., 1988', '470 Lakeside Dr., Sunnyvale, CA 94086', and '(408) 736-2000'. The menu is divided into two sections: 'System Utilities' and 'Disk Utilities'. Under 'System Utilities', there are two options: '[1] System Configuration' and '[2] Function Key Programming'. Under 'Disk Utilities', there are four options: '[3] Disk Conversion Utility (Trackstore)', '[4] New Blank Trackstore Disk Allocation', '[5] Trackstore Disk Description Modification', and '[6] Quit'. At the bottom of the screen, there is a line of text: 'Trackstar and Trackstore are trademarks of Diamond Computer Systems. Apple and ProDos are trademarks of Apple Computer, Inc.'

Figure 4-1

This is the Trackstar Utility program. You will use it to describe the peripherals attached to your system, to configure the function keys, and to Store Apple programs on an MS-DOS disk or network.

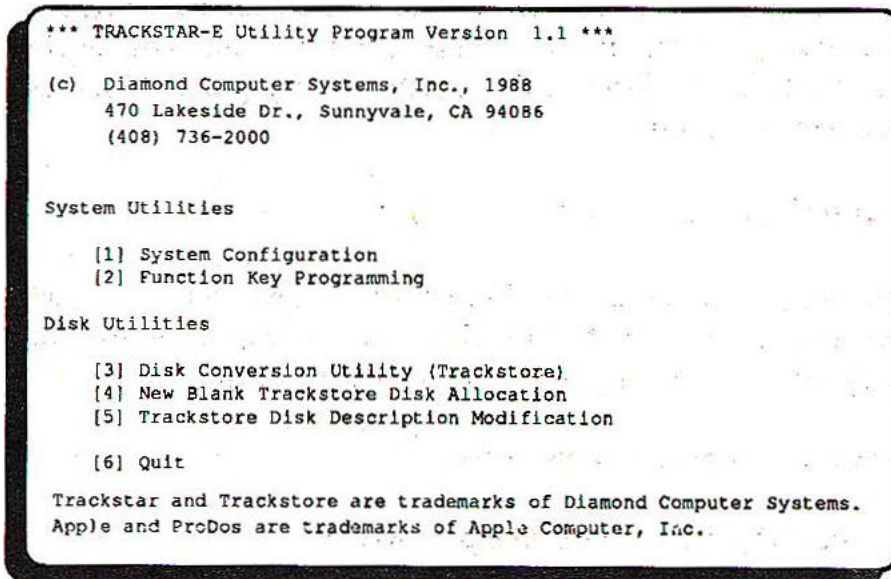
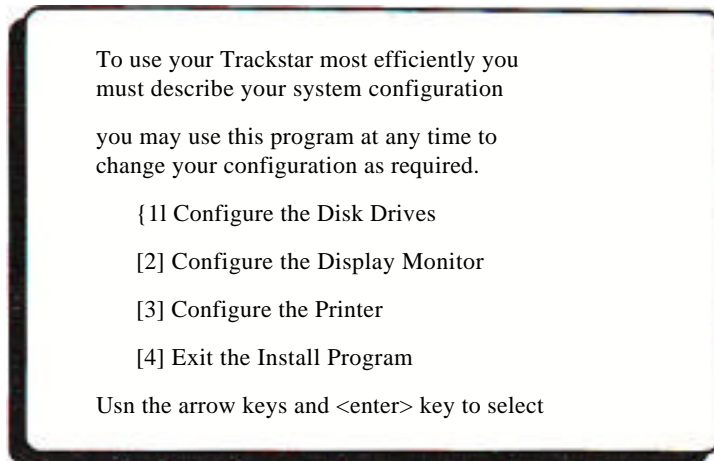

Figure 4-2

For now, you must run the System Configuration section of the Trackstar Utility Program. Press the 1 key and <Enter> now.

You should now be looking at the System Configuration Menu. See Figure 4-2.

The System Configuration consists of three parts, Configuring your disk drives, configuring your display monitor, and configuring your printer ports. As we go through this program, we will address each section in turn.

### Configuring the Disk Drives

First, we will configure the disk drives. In this section you will assign which of your MS-DOS disk drives will be used with the Trackstar and how they will be used while in Trackstar mode.

Press the 1 key and <Enter> now.

You should see the screen in Figure 4-3

This screen shows how your system is currently configured. The LOT6 drives are your Apple DOS boot and data drives. The SLOT drives are those assigned for the special ProDOS large volumes. The Automatic FPBASIC loading disk is the drive from which Apple FPBASIC will be loaded for high compatibility mode.

If these selections appear correct for your machine, you may press the 2 key and <Enter> to exit to the System Configuration Menu at this time. If you wish to change the selections, press the 1 key and <Enter> to proceed with the disk drive configuration.

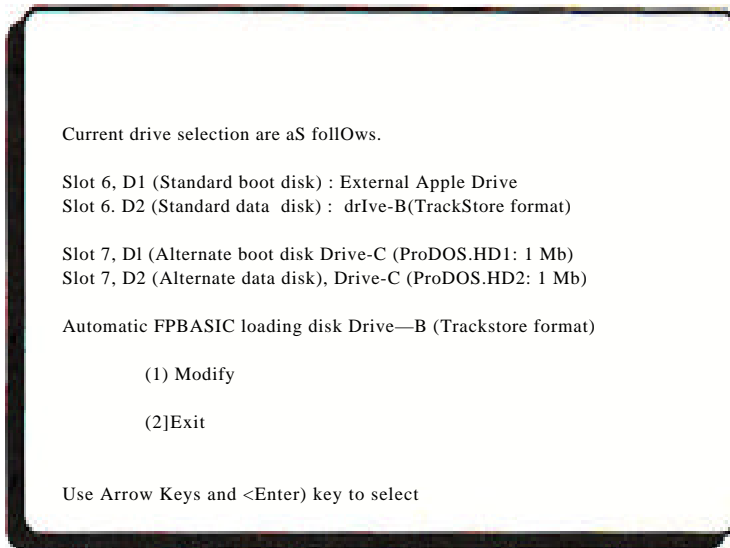

Figure 4-3

If you elect to proceed with the installation, you should see the screen shown in Figure 4-4.

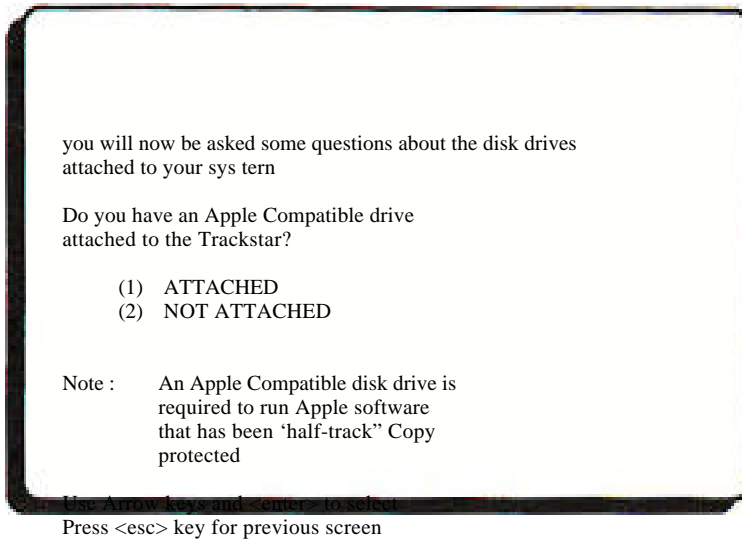

Figure 4-4

If you have an Apple Compatible disk drive attached to your Trackstar, press the 1 key and <Enter>. If an Apple drive is not attached at this time, press the 2 key and <enter>.

The screen shown in Figure 4-5 will now appear. Enter the number corresponding to the type of drive installed as drive A on your MS-DOS computer then Press <enter>.

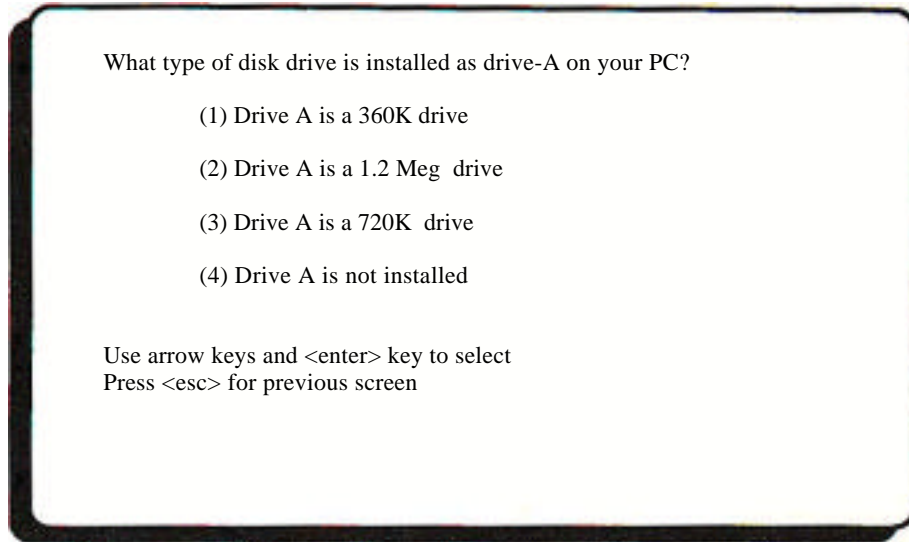

Figure 4-5

The next screen (not shown) asks the same question for the drive assigned to H-. Select the drive type and then press <enter>. The screen shown in Figure 4-6 will now appear

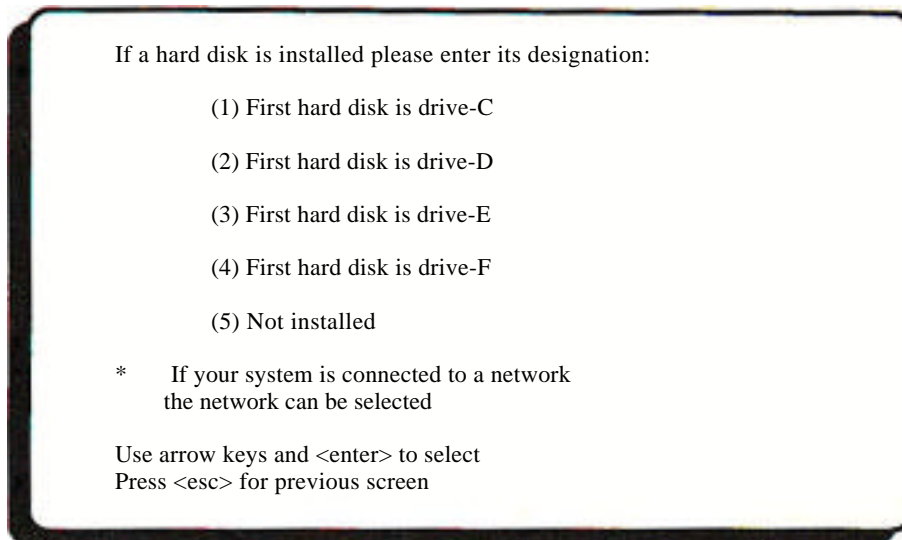

Figure 4-6

The Trackstar can also use any two hard disk drives attached to your system. This screen and the one that follows allows you to specify which two drives are to be accessible to the Trackstar. Should you be lucky enough to have three hard disk drives, you will have to make a choice!

If your computer is attached to a network, you should specify the letter designation of the network file server a~a hard disk drive.

Now we come to the configuration section, Each screen displayed in this section will have certain choices displayed based on the actual equipment installed in your computer. These screens will be similar to the Figures shown in this manual, but not identical with them.

Based on the equipment you specified earlier, the System Configuration Program will suggest which choice you should make at each menu. If you are unsure of what choice to make at a particular screen, then accept the suggestion given. You may return to the System Configuration at any time to change a selection,

You will now see the screen in Figure 4-7. You are selecting which of your disk drives will be used when booting or starting an Apple program, Remember the difference between drives capable of reading actual Apple diskettes and drives that use TrackStore diskettes. Refer back to Chapter 3 if necessary.

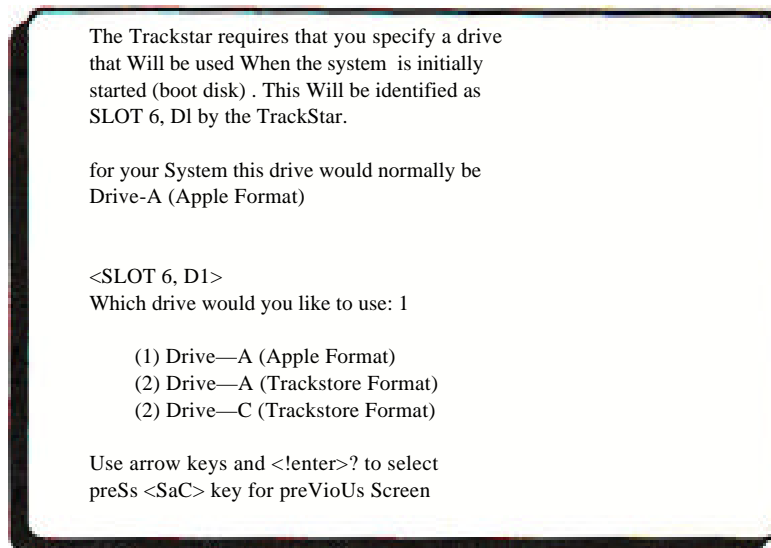

Figure 4-7

Select a drive for SLOT 6, D1 and press <Enter>.

The next screen (not shown) will ask for the drive to be used as the data drive in SLOT 6, D2,

If you have only one floppy disk drive attached to your system, it is OK to have the same MS-DOS disk drive assigned as Apple drive D1 AND 02!

For the last two disk assignment screens you will be selecting the drives for the two special ProDOS volumes. See Figure 4-a (second screen not shown)

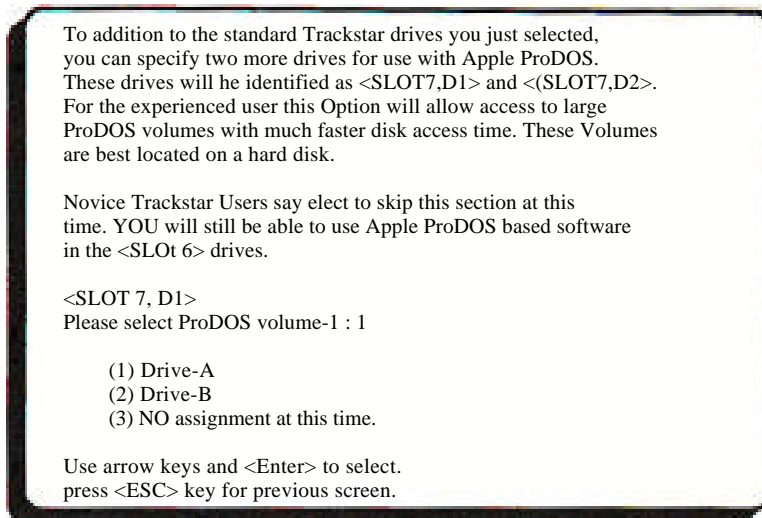

Figure 4-8

The ProDOS volumes can be on any MS-DOS disk drive. Placing them on a hard disk volume is recommended. These volumes can be any of several sizes up to the free space remaining on the specified drive (352K, 704K, 1Mb, 2Mb, 5Mb, or 10Mb each)

Note that the ProDOS 'disks' created with this selection are unformatted as far as the Apple software is concerned. You must use an Apple ProDOS Format Utility to format the volume before storing data on it. For each ProDOS hard disk volume selected, you will be asked the size you want it to be. See Figure 4-9. ProDOS volumes created, on floppy diskette~ will be the largest size allowed by that floppy drive.

The large ProDOS volumes used in SLOT7, D1 and SLOT7, D2 can only be created or modified in this section of the System Configuration program.



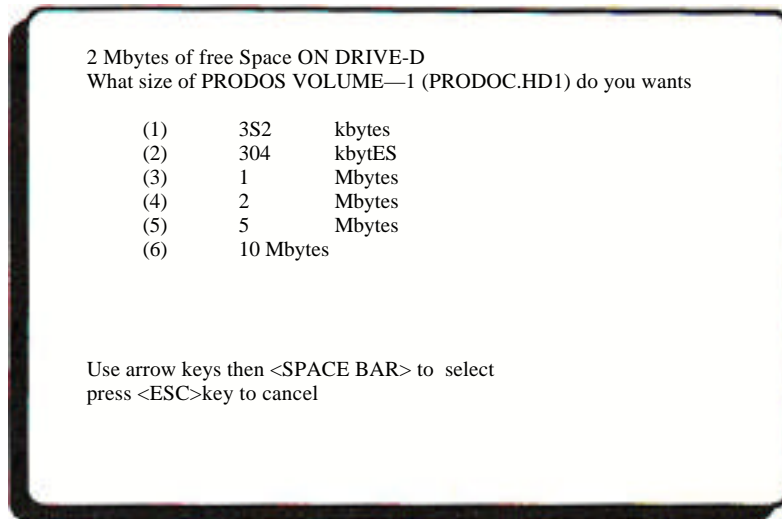

Figure 4-9

The last screen in this section, Figure 4—10, asks for the drive from which FPBASIC is to be loaded. This drive should only be assigned if you have a copy of FPBASIC available and wish to use the Trackstar's High Compatibility mode.

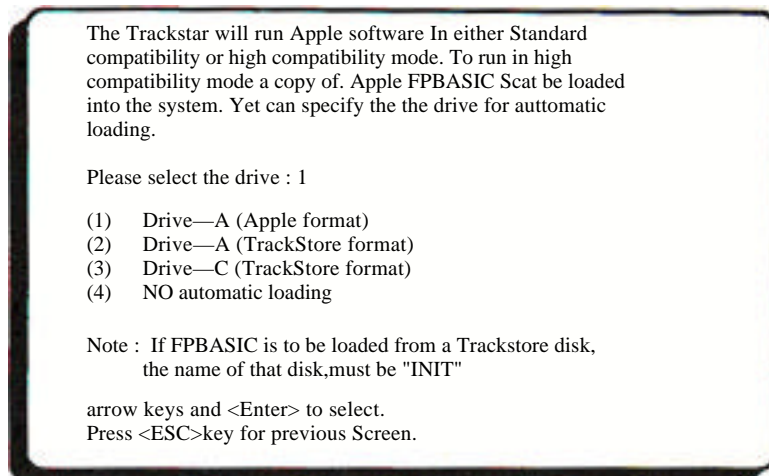

Figure 4-10

FPBASIC can be loaded from an Apple diskette, Usually this will be the Apple DOS 3.3 Master diskette. It can also be loaded from a TrackStore, diskette named <INIT> on the specified MS-DOS drive.

As the Trackstar system is initialized the system will automatically load FPBASIC from a TrackStore diskette named INIT on a hard disk or network, If a floppy drive is specified the system will prompt for a diskette containing FPBASIC to be loaded into that drive.

If you have a copy of FPBASIC, select the drive it will load from now. If this is your first configuration, you should select a drive that can read Apple diskettes.

Press the <enter> key to select.

You will now be presented with the screen as shown in Figure 4-3. This screen displays all of the choices you have made regarding disk drive assignments.

If these choices are correct, press the <spacebar> to continue. If you wish to change any selection, you may use the <esc> key to step back through the drive configuration section.

### Configure the Display Monitor

When you have accepted your selections for the disk drives you will be returned to the System Configuration Menu. See Figure 4-2. The last two sections; Configuring the Monitor and Configuring the Printers, are quite short.

Press the 2 key and <Enter> to Configure the Display Monitor. You will now see the screen as shown in Figure 4-11.

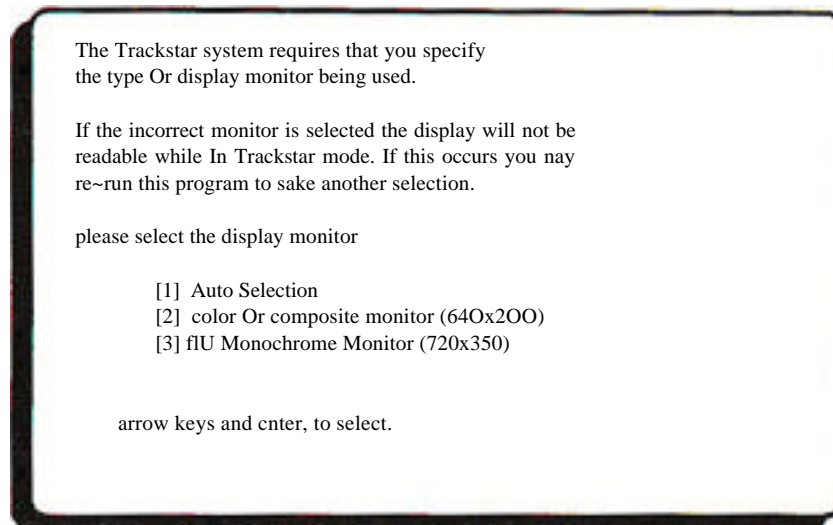

Figure 4-11

If you are unsure of your monitor type choose option [1] and the Trackstar will make a selection for you. Chose option [2] if you have either a Color monitor or if you have a Composite monitor (color or monochrome). Chose option [3] only if you have a 'TTL. Monochrome monitor.

If the incorrect monitor is selected~ the video display in Trackstar mode will be fuzzy and unreadable. If this occurs, you must return to the System Configuration Program and make the correct selection.

Press the <Enter> key to accept the monitor selection.

### Configure the Printers

Once more you will see the System Configuration Menu as shown in Figure 4-2. Select option [3] and press <enter>, to configure your printer(s), See Figure 4-12.

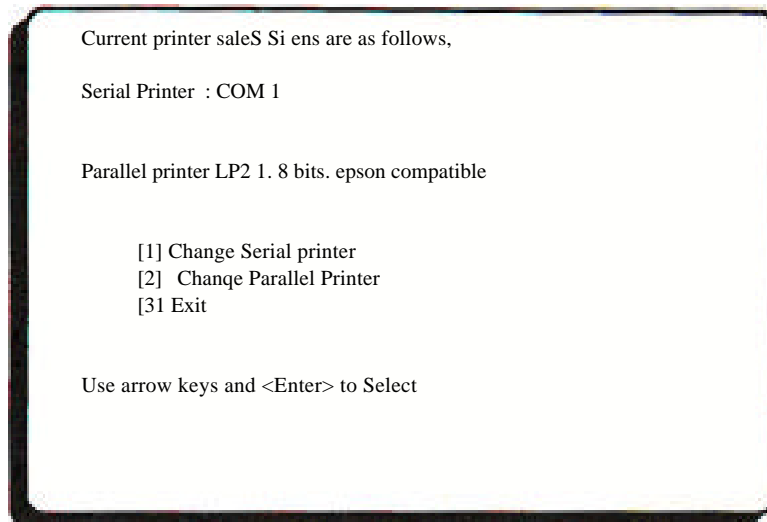

Figure 4-12

The Trackstar uses the printer(s) attached to your MS-DOS computer to output text from Apple programs. You must use this section to describe which COM: or LPT: port(s) your MS-DOS printer is connected to.

Selecting option 1 will display the COM: port currently selected for your machine. The default value is COM1:, the standard value for serial printers. You may select between COM1 and COM2.

Selecting Option 2 will display the LPT: port, data length, and printer type for your parallel printer. The default printer settings are very common and most likely correct for your machine. The Epson Compatible printer is used to describe all printers other than DMP 130/140 series machines. Printer configuration is covered further in Chapter Seven.

#### Exit the Install Program

When you exit from the Printer Configuration section, you will have completed the entire system configuration. Select Option [4] at this time to Exit the System Configuration Menu.

You should now see the Trackstar Utility Program Main Menu as shown in Figure 4-1. Press the 6 key and <Enter> to return to MS-DOS.

You are now ready to run your first Apple program on the Trackstar!

---

## Chapter Five

### Booting the Trackstar System

#### Using The Apple Keyboard

Before you start your first Apple program there are a few things you need to know about the keyboard. Apple computers have three keys that are not available on your MS-DOS keyboard. They are:

- **OPEN APPLE**
- **CLOSE APPLE**
- **RESET**

The OPEN and CLOSE APPLE keys are similar to the SHIFT function. They are used to alter the meanings of the standard alpha keys.

*CLOSE APPLE may sometimes be referred to as SOLID APPLE in Apple documentation.*

For example, in AppleWorks, to begin a PRINT operation you would hold down the OPEN APPLE key and then press P. Many Apple programs take advantage of this feature.

When using the Trackstar you will press <F9> for **OPEN APPLE** and <F10> for the **CLOSE APPLE** function.

The Apple RESET key is used to Reset or Reboot an operating Apple program. This RESET function is available from the **Trackstar Help Menu**.

To access the **Trackstar Help Menu**, you must first be in Trackstar mode. While in Trackstar mode, you can at any time, press the F1 key followed by the ESC key.

Pressing <F1> followed by <ESC> will display the menu shown in Figure 5-1,

*Accessing the Help Menu with FESC will not interrupt your Apple program. If you return to your Apple program without RESETTING or REBOOTING the system that program will continue to run.*

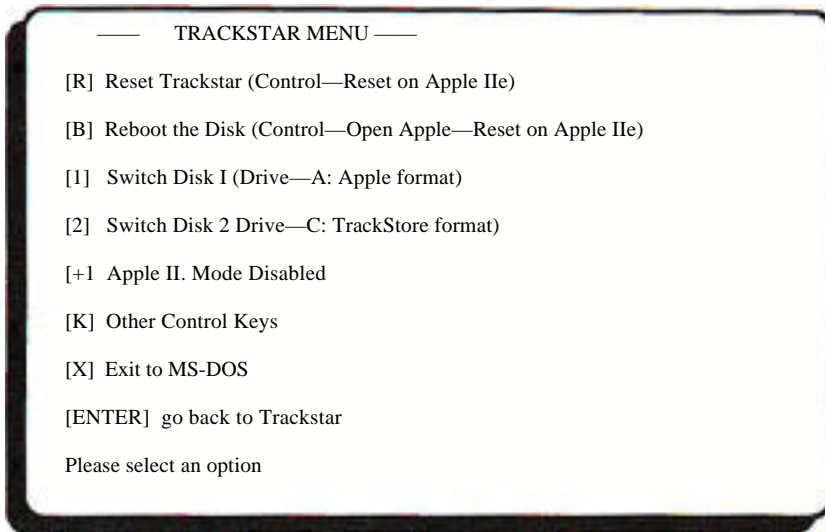

Figure 5-1

Pressing the E key from within the Trackstar Help Menu will cause a RESET to be sent to the Apple program. This would be the same as pressing **CONTROL - RESET** on an Apple.

Pressing the B key from within the Trackstar Help Menu will cause the Trackstar to reboot from the diskette in drive D1 This is the same as pressing **CONTROL OPEN-APPLE RESET** on an Apple.

While in the Trackstar Help Menu, you can return to your Apple program by pressing ENTER.

The other options in the Trackstar Help Menu will be covered in the following Chapters.

*Many early Apple programs do not accept lower case characters. If you are using such a program, remember to use the CAPSLOCK key*

### Booting an Apple diskette

The Trackstar is initialized by running the program **STAR.COM** from MS-DOS. STAR COM can be run from any MS-DOS volume; floppy disk, hard disk, or network.

If you have been following this manual in sequence, a configured copy of STAR.COM should be in your B~drive now.

At the B prompt type STAR and press the <enter> key. You will see one of the following two screens:

### High Compatibility Boot

If you specified during System Configuration that you wished the system to initialize in High Compatibility mode from a floppy diskette, you will see the screen in Figure 5-2.

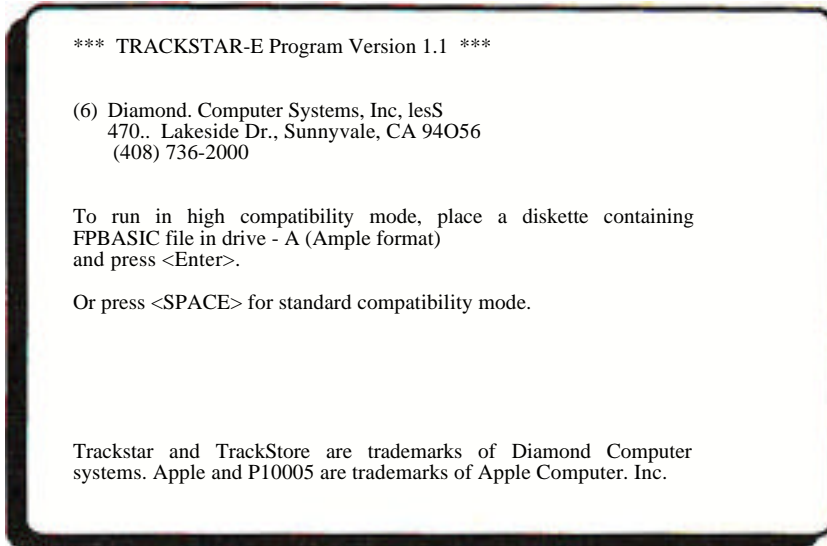

Figure 5-2

If you specified that FPBASIC was to be loaded from a floppy drive, then insert a diskette in that drive now and press <enter>. If a diskette containing FPBASIC is not available at this time, you may press <spacebar> for a Standard Compatibility boot. See figure 5-3.

Similarly, if you specified that FFBASIC was to be loaded from a TrackStore diskette on a hard drive or network, the system will attempt to load it now. If a TrackStore diskette named INIT, or FPBASIC itself, is unavailable on the specified drive a warning message will appear. You may then press <spacebar> for a Standard Compatibility boot.

### Starting the Apple Program

You should now see a screen similar to the one displayed in Figure 5-3. The exact menu is based on the choices you made during the System Configuration and maybe different from the one displayed here.

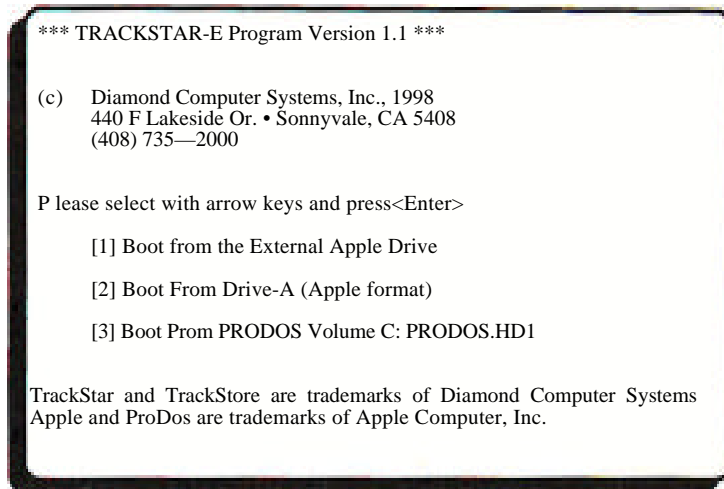

Figure 5-3

You may now be given a few options. If you have an External Apple drive attached to your system, you can insert an Apple diskette in it now and press the <enter> key. Or...

If you have an MS-DOS 360K drive that you specified was for use with Apple diskettes, you may place an Apple diskette in that drive now and press the <enter> key.

If you specified that the system would boot from a TrackStore diskette, hard disk, network file server, or ProDOS volume, refer to Chapter Six for more information on those options.

One last press of the <enter> key and the Language Arts banner will be displayed at the top of the screen, the disk drive will spin, and the Apple program will load and run.

Remember

Many Apple programs require that CAPS LOCK be enabled.

To return to MS-DOS hold down the <alt> key and press the <esc> key.

If problems occur, please check your installation and review Chapter Three on Apple/MS-DOS compatibility.



## After the Basics

Now that you have the basics down we can go on to cover more detailed aspects of your Trackstar System. The following chapters will introduce you to features that will enhance the use of Apple software on your computer.

---

## Chapter Six

### Diskettes In Detail

#### Apple Diskettes

The Apple programs that you will be using are provided on standard 5,25" floppy diskettes. These diskettes can only be read on an Apple compatible or 360K MS-DOS disk drive. Your Trackstar system comes equipped with an Apple compatible drive interface for just this purpose.

As you proceed with this chapter, you will learn how information is stored on floppy diskette and how you may copy these Apple programs to a floppy, hard disk drive or file server on your MS-DOS computer.

#### The TrackStore Concept

MS-DOS programs and data are stored on MS-DOS diskettes in a way that is quite different from the way Apple programs are kept on Apple diskettes. This is why an MS-DOS system cannot read Apple diskettes (and vice versa) without a product like Trackstar.

In order to store Apple programs on your MS-DOS disks you must reserve a special place for them. This special place, which can be recognized by both the Apple and MS-DOS systems, we will call TrackStore. A TrackStore file or "disk" is an imitation of an Apple floppy disk on an MS-DOS file.

First, some numbers: An Apple 5.25 diskette can hold up to 140K (142,000 characters) of information. An MS-DOS floppy diskette can hold 360K to 1,440K of information depending on its type.

A hard disk drive can contain 10 to 80 million (or more) characters.

In preparation for storing the contents of an Apple diskette on an MS-DOS drive, we reserve an area 266K long on your MS-DOS disk. This will contain all of your Apple data and formatting information. This reserved area is the *Trackstore* disk. When we copy all of the files from one of your Apple diskettes into the TrackStore area, you will be able to run Apple programs from it just as if it were an Apple diskette.

You can have as many TrackStore disks on your MS-DOS system as you have room for. This will typically be one on a 360K diskette, two on a 720K diskette, four on a 1,200K(1.2Mb) drive. and many on a hard disk.

Your PC recognizes the TrackStore area as an MS-DOS data file. It can be copied, moved, and archived just like any other data file. The one thing the MS-DOS system cannot do by itself is to use the contents of the TrackStore disk.

You will give each of your TrackStore disks a unique name. This name can be one to eight characters long and will serve to identify it to the Trackstar system. It will be stored on the MS-DOS disk under that name with the suffix **.app**.

For example you might have a TrackStore disk called **GRAPHICS**. It would be stored in MS-DOS as a 266K file called **GRAPHICS.APP**. Within GRAPHICS.APP would be the contents of an Apple diskette.

The Trackstar system allows you to assign an additional 46 character description to the TrackStore disk at the time it is created. You can use these 46 characters to help you remember the contents of specific diskettes. This is especially useful when you have dozens of TrackStore disks on a hard disk.

#### About Apple Diskettes

In order for you to get the most utility from the Track Store concept it will be useful to cover a few details on the workings of floppy disks. This section is particularly important if you will be storing copy protected software on your hard disk.

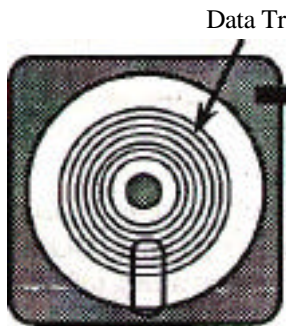

Figure 6-1

**Data Tracks** Information is stored on a floppy diskette in a fashion similar to that used by audio or video tapes. This information is stored in concentric rings around the circumference of the diskette; each of these rings is called a **Track**. See Figure 6-1

Since each Track must be a certain distance away from its neighbors, an Apple diskette can contain only 40 such Tracks. During the early days of Apple computers, a clever programmer figured out that he could prevent other people from copying his software by placing these Tracks at other than the standard positions.

Since the only other place Tracks could be placed was halfway between the standard Track locations the practice became known as half-tracking. Placing a Track at location 1:5 meant that information could not be stored at locations 1 or 2 (too close to the other) so the maximum density of 40 Tracks was preserved.

TrackStore allows you the option of copying all possible half-tracks to an MS-DOS file. This uses double the usual space, but allows more programs to be copied to MS-DOS media.

When copying a protected diskette, it is difficult to tell which half tracks actually contain data. As you will see later in this Chapter you will have the option of copying all 80 tracks from a protected diskette to a TrackStore disk.

Only an Apple or Apple compatible drives are capable of reading data stored on half tracks. MS-DOS 360K disk drives can only read the standard 40 data tracks.

#### Creating a TrackStore Disk

To create a TrackStore disk you must first run the TSUTILITY program to access the Disk Utilities Menu. See Figure 4-1.

Options 3, 4, and 5 on this menu apply to TrackStore diskettes.

#### The Disk Conversion Utility

The Disk Conversion Utility allows you to copy an Apple 5.25" diskette to a TrackStore disk on an MS-DOS drive. You must have an Apple compatible or MS-DOS .360K drive connected to your Trackstar to run this utility~

Most Apple programs can be copied to the TrackStore disk. Some programs are heavily copy protected and will not convert correctly. The conversion utility will be unable to tell if these programs did copy correctly. If you suspect a program has been copy protected in this way, you should attempt to run the copy. If the TrackStore copy fails to run, you will be limited to running that particular program from the Apple Drive.

Some copy protection scheme render the copy process unreliable. If the copy fails on the first attempt you may wish to try a second time before deciding the program will not copy at all.

*Before copying any software to a TrackStore disk, you should read the copyright notice accompanying the original software. Most publishers allow duplication to a hard disk for personal use by the purchaser: this may not be true in all cases. It is especially Important if you are copying programs to a file server that many individual have access to.*

After selecting Option 3 from the Disk Utility Menu, you will be asked the following question&

**Target Drive (A/B/C/D/E/F):**

The Target drive is the drive to which the Apple diskette will be copied. A TrackStore diskette will be created for the Apple information that will be stored on this drive.

Next you will be asked for the name of the Target Disk.

**Trackstore Disk Name STARTUP1**

Enter a name for the new TrackStore disk now. You are allowed a maximum of eight characters. Pressing <enter> without specifying a TrackStore disk name will cause the name STARTUP1 to be used.

You may next enter a 46 character descriptive statement for the TrackStore disk,

**Trackstore Disk Description:**

This description may be any character string such as **AppleWorks Backup or Educational Game Disk** Pressing <enters without typing a description will leave this description blank.

The next question before the copy begins pertains to copy protection as described earlier.

**TrackStore Disk Density (40/80):**

Pressing the 4 key here will result in the 40 regular tracks of the Apple diskette being copied to your new TrackStore disk. This will consume 266,240 bytes (roughly 265K) of space on your MS-DOS disk. There is only room for one 40 track TrackStore diskette on an MS-DOS 360K drive. .

Pressing the 8 key here will result in all 80 possible tracks being copied, **the** 40 standard tracks and the 40 possible half-tracks. This will consume twice as much space on your MS-DOS disk,

If you suspect a program is half-track protected or if it does not work after a 40 track copy then use option S. Remember you must have an Apple compatible disk drive to use option S.

*If a program is not half -track protected and an 80 track conversion is done, the program will still work correctly although it is wasteful of space.*

The last question asked before the disk conversion takes place allows you to specify which drive contains the Apple diskette to be copied.

### **Source Drive**

You may now specify the drive from which the Apple data is to be copied.

The copy will now proceed

### New Blank Disk Allocation

then Blank Disk Allocation Utility allows you to create an empty TrackStore disk. The information required is the same as for the Disk Conversion Utility above.

### **IMPORTANT~**

A newly created TrackStore disk is similar to a new, blank floppy diskette. It contains no information and must be formatted before it can be used. To format the *TrackStore* disk, you can use any Apple format utility; DOS 3.3 or ProDOS.

*If you try to access a new TrackStore disk with out formatting it, an I/O ERROR message will appear.*

### Trackstar Disk Description Modification

When you convert an Apple disk into a TrackStore file or create an empty TrackStore disk, you have the option of entering a 46 character description of the disk. The Trackstar -Disk Description Modification Utility allows you to change that 46 character description.

To change the description of a particular Trackstore disk, you must first specify the location of the MS-DOS drive on which that TrackStore disk is stored.

**Target Drive (A/B/C/D/E/F):**

The system will now list all of the Trackstore disks stored on the specified drive. See Figure 6-2.

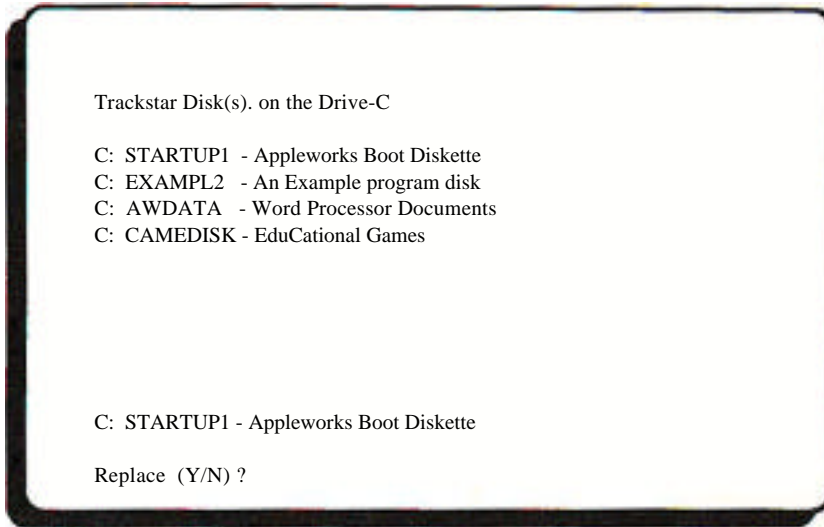

Figure 6-2

You may select the TrackStore disk whose description you would like to change by using the up and down arrow keys. The selected TrackStore disk will be displayed in inverse video.

While a TrackStore disk is selected, you may enter a new description by typing over the old one. Press the <enter> key to finish the description.

*Pressing <esc> will end the entry and return you to the Disk Utility Menu.*

After you have finished changing the disk description by pressing <enter>, you will be asked to confirm the change.

**Replace (Y/N)?**

Pressing Y will replace the old description with the new. Pressing N will cancel the change.

You may now modify more *TrackStore* disk descriptions. You must press the <esc> key to return to the Disk Utility menu,

### Changing the *TrackStore* disk name

You will recall from an earlier section that *TrackStore* disks are stored on an MS-DOS diskette as none to eight character file name plus the suffix **APP**. If you wish to change the name of the *TrackStore* disk itself you must use the **RENAME** command from within MS-DOS. Once it is created you cannot change the *TrackStore* disk name from within the Trackstar system. Trackstar will only recognize MS-DOS filenames with a **.APP** suffix as *TrackStore* media. Please refer to your MS-DOS users manual for more information on the **RENAME** command.

### Copying Apple Diskettes to Apple Diskettes

As was mentioned earlier, only the External Apple Drive or a compatible MS-DOS 360K drive is capable of reading and writing Apple formatted 525" diskettes. If you wish to run a program or read a file created on an Apple computer you must do so using the Apple compatible or 360K drive. Likewise, if you want to create a disk on your Trackstar that can be read on an Apple computer you must create that disk on your External Apple or 360K Drive.

As long as the External Apple Drive is configured as either Apple drive D1 or D2 you can use any Apple copy routine to duplicate from an Apple diskette to an Apple diskette. You must follow the instructions supplied with the copy program. You must refer to the section within those instructions on Single Drive Copy.

### Copying *TrackStore* disks to Apple Diskettes

It is also possible to copy the contents of a *TrackStore* disk back to an Apple diskette in the External Apple or MS-DOS 360K Drive.

Before you do this, you must keep the following points in mind:

40 track *TrackStore* disks may be copied back to an Apple diskette without restriction using any Apple copy program.

80 track *TrackStore* disks may also be copied; however, you must use an Apple copy program capable of copying half-tracked software. Half-tracked software is by definition copy protected. The result of attempting to copy this type of software is not guaranteed.



Copying TrackStore disks to TrackStore disks.

Much the same restrictions apply to copying from one TrackStore disk to another TrackStore disk as apply to copying from TrackStore to Apple.

A destination TrackStore must already exist, This can be an existing disk or one newly created using the Disk Utilities menu

40 track disks may be copied without restriction using any Apple copy program

80 track disks may be copied using an Apple copy program capable of copying half-tracked software, The result of this type of copy is also not guaranteed.

*Remember that a TrackStore disk is actually an MS-DOS type file with the suffix **APP**. From MS-DOS you can use any copy utility to duplicate TrackStore disks with no loss of information. This is true of both 40 and 80 Track TrackStore disks.*

Selecting a TrackStore disk

Once you have created several (or many) TrackStore disks on a particular MS-DOS drive, you need some way to select between them.

For example; Suppose you have designated your drive C: (a hard disk, say) as Apple drive D2. Your hard disk may contain 10 or 15 or more TrackStore disks. Now you want to CATALOG or list the contents of the "Apple disk" now in Apple drive D2.

How does the system know which of the 10 or 15 TrackStore disks available is the one you really wish to see?

The answer to this is in the Switch **Disk** feature.

Switch Disk Explained

Remember the Trackstar Help Menu from Chapter Two? Pressing <F1> followed by <esc> while using an Apple program will display this menu. See Figure 5-1.

Within the Trackstar help menu there are two Switch Disk options:

- 1] **Switch Disk 1** (*Apple Drive D1*)
- 2] **Switch Disk 2.** (*Apple Drive D2*)

Switch Disk 1 will allow you to select and switch between multiple TrackStore disks that may be contained on the MS-DOS drive defined earlier as Apple drive D1.

**Switch Disk 2** will allow you to select and switch between multiple TrackStore disks that may be contained on the MS-DOS drive defined earlier as Apple drive D2.

Press 1 or 2 to select a TrackStore disk from the specified MS-DOS drive.

*If you attempt to use "Switch Disk" on an Apple format diskette, it will have no effect.*

When Switch Disk is selected all TrackStore disks contained on the specified Ms-DOS drive will be displayed. See Figure 6-3

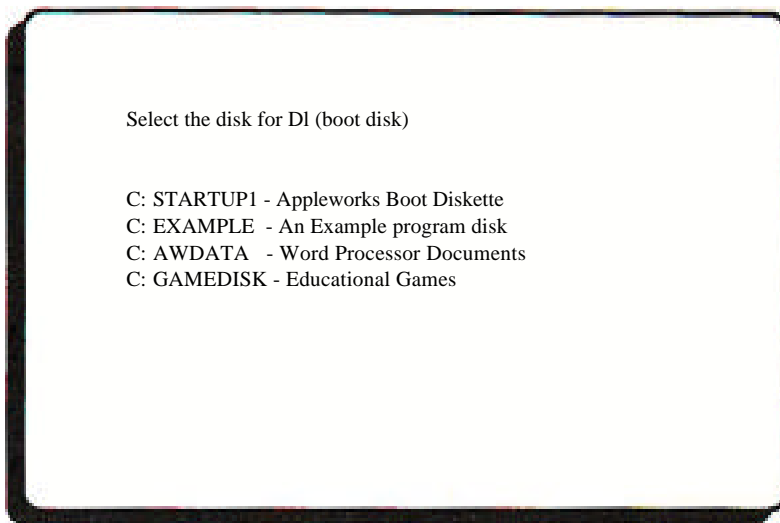

Figure 6-3

You may select a TrackStore disk using the arrow keys. Using the arrow keys, select the TrackStore disk you wish to use and press <enter>.

Those of you familiar with the Program AppleWorks will recognize the following example:

AppleWorks requires three diskettes: A boot diskette (used only once), a program diskette, and a data diskette,

In an Apple computer, the boot diskette must first be placed in Apple drive D1 and started. AppleWorks will partially load and then request that the Boot disk be removed and replaced with the Program disk in Apple drive D1. You can then press the <enter> key and AppleWorks will begin.

In the Trackstar system, if you have previously copied each AppleWorks diskette to a corresponding *TrackStore* disk on an MS-DOS drive, you would use the following procedure:

- 1) Place the MS-DOS disk containing the *TrackStore* copies of AppleWorks into the drive previously assigned as Apple drive D1.
- 2) Use [1] Switch Disk to select the specific *TrackStore* disk containing the AppleWorks Boot.
- 3) Still at the Trackstar Help Menu press the B key to reboot Trackstar from the disk assigned to Apple drive D1 (the AppleWorks boot disk).

The system will boot. AppleWorks will then display the message *Insert the AppleWorks Program Diskette in Drive 1 and Press RETURN*

- 4) Press <F1> followed by <esc> to return to the Trackstar Help Menu.
- 5) Use [3] Switch disk to select the specific *TrackStore* disk containing the AppleWorks Program.
- 6) Press <enter> to return to the Apple display.
- 7) Press <enter> again to indicate that you have placed the AppleWorks Program diskette in drive 1:

AppleWorks will now finish booting. You can now use [2] Switch Disk to assign an AppleWorks data disk to Apple Drive, D2.

## Booting the system from a TrackStore disk

It is not always necessary to boot the Trackstar system from a disk in the External Apple Drive. If you have previously copied Apple diskettes to TrackStore diskettes on your MS-DOS floppy diskettes, hard disk drive, or network file server, you can boot your 'trackstar System directly from there, without first using an Apple diskette.

The first step in booting from a TrackStore disk instead of the Apple Drive is to use the **TSUTILITY** program to assign an MS-DOS drive as Apple Drive D1. This MS-DOS drive can be any drive including a hard disk or file server.

The Trackstar System will always boot from the disk in drive D1.

There are three special names reserved for TrackStore disks. These names are **STARTUP1**, **STARTUP2**, and **INIT**.

If you have a TrackStore disk named STARTUP1 in Apple drive D1, then that TrackStore disk will be automatically selected when you boot from that drive. If there is no TrackStore disk named STARTUP 1 on Drive D1 you will be asked to select one from the SWITCH DISK menu as shown in Figure 11.

You can, if you wish, boot from a TrackStore~ disk other than STARTUP1. To do this, use the SWITCH DISK menu to select another disk prior to booting. The last TrackStore disk selected from the SWITCH DISK menu (for drive D1) will be the one used during the Apple boot process.

STARTUP2 performs the same function of being selected as the default data disk for Drive D2.

Now, If you have configured your Trackstar such that your hard disk is Apple Drive D1 and you have a TrackStore disk on that drive named STARTUP1; then, when the STAR.COM program is run the Trackstar system will be started from the TrackStore *diskette* STARTUP1 on your MS-DOS hard disk.

INIT is the TrackStore diskette from which FPBASIC can be loaded as specified during system configuration. Refer to Chapters Three and Four for a review of FPBASIC and INIT,

## Booting from a large ProDOS volume

In Chapters Three and Four it was discussed how you might create large ProDOS volumes for use with your Trackstar system. If you have created such a large ProDOS volume, you will be offered the option of booting from that volume when the Trackstar system is initialized. If you select this option the Trackstar system will be started from the program `STARTUP.SYSTEM` located in the root directory of that ProDOS volume.

Please refer to your ProDOS users manual for more information on the booting process.

---

## Chapter Seven

# Features and Functions

### Using Apple Printers

Apple computers have slots for controller cards similar to the slots in your PC where the Trackstar is connected. In an Apple computer, cards are placed in these slots to interface with a printer attached to the system. There are eight of these slots numbered from zero to seven in an Apple II computer. There are seven slots in an Apple IIe numbered one through seven. An Apple IIc has no slots but uses the same convention as the other machines.

When an Apple program sends text to a printer, it addresses that printer by the number of the slot that its controller is plugged into. i.e. you must tell each Apple program which slot contains the controller card that drives your printer. If you had two printers on an Apple computer, with their controllers in slots one and two, you would select a specific printer by instructing the program to use either slot number one or slot number two.

Most Apple programs have a Setup Menu that allow the user to select the slot number, Controller Card and Printer.

The Trackstar has (as far as programs are concerned) two slots for printers. These two slots are slot number one and slot number two.

*The Apple DOS 3.3 commands PR#1, PR#2, IN#1, and IN#2 access these two slots.*

Since the Trackstar itself has no slots for controller cards, it uses the printer ports on the PC for that purpose:

Your PC has two kinds of connectors for printers: parallel and serial. Parallel printers are addressed in MS-DOS as an LPT type devices. Serial printers are addressed as an MS-DOS CaM type device. Please refer to your Owners Manual for a complete description of printers.

The Trackstar uses slot number one to control a parallel printer connected to an LPT port.

Trackstar slot number two is for controlling a serial printer connected to a COM port

A brief technical note regarding data length: When an Apple program sends a character to the printer, the seventh bit is always set: When MS-DOS sends a character to the printer, seventh bit is always cleared. The data bit length will be set at Eight in most circumstances. If problems occur with graphics printing, it may be necessary to change the data length to seven.

## General comments on Trackstar I/O

Apple DOS and Apple ProDOS use certain conventions when directing output to a printer or requesting input from some other peripheral device. The Trackstar supports these conventions and will work correctly with any Apple program that uses these same methods.

To increase speed some programs bypass these programming conventions and attempt to access the Apple serial or parallel cards directly. These programs will not work correctly with the Trackstar.

Telecommunications programs or any program designed to use a modem are examples of software that may exhibit this problem.

## The Apple Game Port

The Trackstar supports the Apple game port. This port can be used with an Apple joystick or any Apple game device equipped with a nine pin D type connector or a 16 pin DIP connector.

Annunciator ports one through three are not supported by the Trackstar Game I/O. This is a little used Apple feature and will not interfere with the operation of Apple joysticks or game paddles.

## Telling Time

The Trackstar system will use the MS-DOS system clock (if installed) in your PC to provide the time to Apple programs that use it. The Trackstar clock is located in Slot 5 of the system and is Thunderclock compatible

## Switching to MS-DOS

You will remember from Chapter Five that you can switch from the Trackstar system to the MS-DOS system by using the Trackstar Help Menu. The Trackstar Help Menu is accessed by pressing <F1> followed by <esc>.

While in the Trackstar Help Menu you can press the X key to return to MS-DOS. At this time you will be given an option: Press the Y key to terminate the Trackstar operation, stop any running Apple program, and return to Ms-DOS, or Press the N key to cancel this option and return to the Trackstar System.

Once you have returned to Ms-DOS in this fashion you must execute the STAR.COM program to re-enter the Trackstar System.

An alternative method of switching between Apple and MS-DOS systems can be used by holding down the <alt> key while pressing <esc>.

If you ~re using the Trackstar System when you hold down <alt> and press <esc> you will be switched to the MS-DOS system. You can now use your MS-DOS system as if the Trackstar were not present. Any running Apple program will continue to run until an I/O request is made. It will then suspend until Trackstar mode is re-entered.

Holding down the <alt> key and pressing <esc> again will return you to the Trackstar System.

You can perform this operation as many times as you like.

*While the Trackstar system is running it uses about 80K of the memory in your PC,*

## Programming the Function Keys

Trackstar allows you to program the function keys on the PC keyboard for your convenience. To do so, you must run the TSUTILITY program and select Option 2, Function Key Programming, from the Main Menu. The Function Key menu will be displayed on the screen: See Figure 7-1.



The following key strings will be entered when the function keys are pressed in Trackstar Mode.

```
[F3 ] : CATALOG, D1^M
[F4 ] : LOAD
[F5 ] :LIST^M
[F7 ] : SAVE
[F8 1] : RUN HELLO^M
[Quit] : Exit the program
```

Use the up/down arrow keys and press the <Enter> key to select a function key to programs.

Figure 7-1

There are 6 function keys available for programming, F3 through P8. Keys F1, P2, P9 and FIG are dedicated to control key functions, and cannot be programmed by the user.

You may select the [QUIT] option to return to the previous menu

Use the arrow keys to select the function key you wish to modify, press the <enter> key and then type the selected characters, words or commands. The definition can have up to 32 characters, including <enter>.

The <DEL> key is used to delete selected characters, and <END> is used to indicate that the command string is complete.

When you have finished typing in your modified key definition, press the <END>key to return to the menu. You may then choose to modify another key, or select the [QUIT] option to return to the Main Utility menu.

These Function Key definitions are maintained in the STAR COM program used to initialize the Trackstar system. If you wish to maintain several sets of Function Key Definitions you may do so by configuring multiple copies of the STAR.COM program, giving each copy of the program a different name.

---

## Chapter Eight File Transfer

### About File Transfer

This feature of your Trackstar system allows you to move data from your Apple system to the MS DOS system. Data created on an Apple computer can be used in MS DOS programs and vice versa. For example, spreadsheets created in AppleWorks can be used by Lotus 1 2 3. The possibilities are many and each enhances the utility of your Trackstar.

Any text or Binary file can be transferred. Data not in a text or binary format can be transferred only after it has been converted to text or binary.

Most programs keep their data in a text file format so performing the conversion is a straightforward process. Some programs, notably AppleWorks, keep their data in an internal format that can not be read or used by other software. These programs usually provide a way of creating a text file output for their data. In AppleWorks, the PRINT feature will allow you to print the contents of a document to a disk file as if it were being sent to a printer. This disk file is in a text format and can be used by the Trackstar File Transfer Utility. Programs written in the BASIC language can be transferred in a similar fashion,

Two programs are provided on the Trackstar Utility Disk for the purpose of File Transfer. The first program is used to transfer data to and from Apple DOS 3.3 disks and the second program serves the same function for ProDOS files.

Both Programs will transfer files from Apple formatted diskettes to any MS DOS volume. The External Apple Disk drive or an Apple compatible 360K drive must be configured as Apple Drive D1 for File Transfer to work.

### Apple DOS 3.3 File Transfer

The DOS3.3 File Transfer Utility is kept in a TrackStore disk called FILETRAN. This TrackStore disk is contained on the Trackstar Utility Disk. You can use the SWITCH DISK command to access this program.

Before you can use the File Transfer Utility, you must first copy it to a bootable DOS 3.3 diskette.

The DOS 3.3 File Transfer program itself is called FILE TRANSFER. It is an Apple binary program and maybe copied to the Apple 5.25" diskette using the program FID. FID is a file copy utility contained on the Apple DOS 3.3 Master Diskette supplied by Apple; If you do not have a copy of the DOS 33 Master you can use one of the many other copy programs that can copy individual files.

Before you begin make, sure that:

- 1) The FILE TRANSFER program is on an Apple DOS diskette
- 2) The External Apple or 360K Drive is configured as Apple Drive D1.

### Starting the Program

Now that the FILE TRANSFER program is on an Apple DOS diskette in drive D1 we are ready to begin.

At the Apple prompt type: **BRUN FILE TRANSFER** <enter>

The File Transfer menu will appear on the screen: See Figure 8-1.

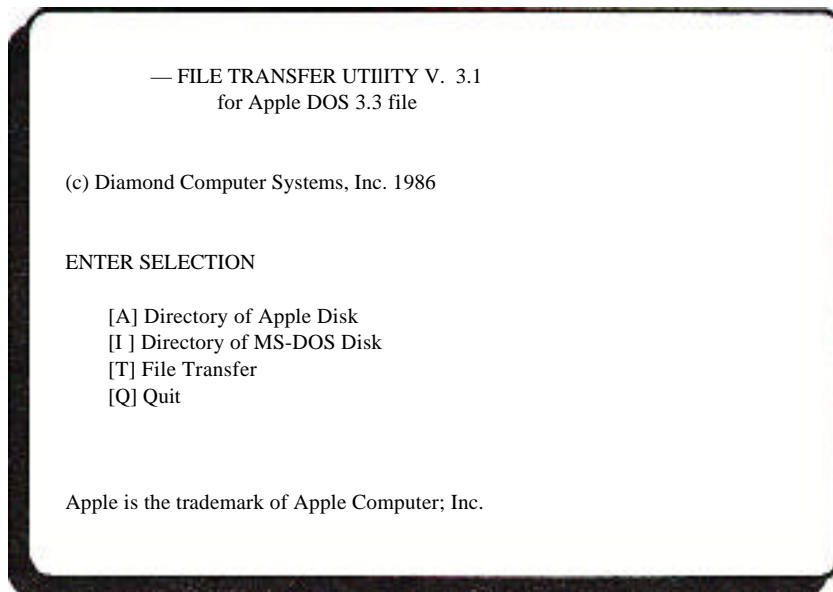

Figure 8-1

Selecting Option [A] from this menu will display a catalog of all Apple programs contained on the Apple diskette in the compatible drive. You can use this option to verify that the programs you wish to transfer to MS DOS are on the disk. It can also be used after a file transfer from MS DOS to verify that the programs did transfer as expected,

Option ill will perform the same function of listing files on an MS DOS disk or volume. You will be asked to specify the letter of the MS DOS drive you wish. to see a directory of.

Only files in the selected directory or subdirectory of the specified drive will be displayed. . You can only transfer files to or from the currently selected MS DOS subdirectory.

Option [Q] will exit the Vile Transfer Utility. You must re-boot from an Apple diskette when you exit the File Transfer Utility.

Option I'll will begin the file transfer process.

When Option [T] is selected you must supply the information requested in Figure 15.

Figure iSis a composite screen composed of all of the questions to be answered. Each question will appear on the screen in order, from top to bottom

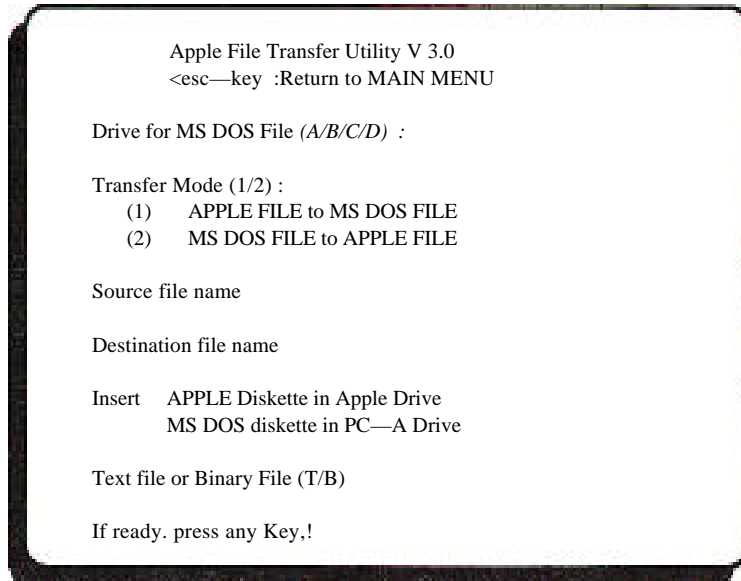

Figure 8-2

Note:at this time an Apple diskette must be in Apple drive D1.

Question A: **Drive for MS DOS File (A/B/C/D):**

Please specify the drive that MS DOS files are going to be copied to or from, This can be any drive A, B, C, or D. You may use a hard disk, floppy disk, or file server as a MS-DOS drive.

Question B: Transfer Mode (1/2) :

- (1) **APPLE file to MS DOS file**
- (2) **MS DOS file to APPLE file**

You may specify, at this time, in which direction the Vile Transfer will go. Entering 1 will copy files from the Apple diskette to an MS DOS disk. Entering 2 will transfer files from an MS DOS disk to an Apple diskette.

Question C: **Source File Name :**

Please specify the name of the file you wish to transfer. To Transfer all files on the source diskette enter the wildcard \*.\* as the source file name,

There are several important points about file names that need to be understood here, Apple filenames may be much longer than MS DOS file names and can contain characters that are not allowed by MS DOS. It is up to the user to verify that illegal characters are not contained in the Apple file names. If an illegal file name is encountered during the file transfer, an error message will be generated and the transfer will stop. if you limit yourself to letters and numbers in a file name with the first character being a letter you will not encounter this problem.

Apple file names can be up to 30 characters long. MS DOS file names may be only eleven characters in length (including the suffix). When transferring an entire Apple disk to MS DOS, theme names will be limited to eleven characters, The first eleven characters of each Apple file name will be used to create the new MSDOS files. If two Apple files have file names with the first eleven characters the same, only the second file will be transferred.

When executing a File Transfer from MS DOS to Apple, the full filename is converted and no illegal character conflicts will occur.

Question D: **Destination file name:**

If you wish to supply a different name for the transferred file you may do so here. If you press <enter> without specifying a new file name, the old name will be used as described above. if you specified a wildcard (\*.\*) as the source file, then press the <enter> key in response to this question.

**Question E: Text file or Binary file (T/B)?**

This question will only be asked when transferring a file from MS DOS format to Apple format. Pressing the T key will make the newly created Apple file a textfile. Pressing the B key will transfer the data as a binary file.

When ready, press the <enter> key to begin the File Transfer. Pressing the <esc> key at any time will stop the transfer and return you to the File Transfer main menu.

**A Few Technical Points**

When copying TEXT files from Apple DOS 3.3 to MS DOS:

- a) Bit 7 of The ASCII text is cleared.
- b) Carriage Return code (hex 0D) is converted to Carriage Return (hex 0A) and Linefeed (hex 0D).
- c) End Of File mark for Apple DOS 3.3 (hex 00) is converted to Control Z (hex 1A).

When copying TEXT files from MS DOS to Apple DOS 3.3

- a) Bit 7 of the ASCII text is set.
- b) Linefeed code (hex 0A) is ignored
- c) MS DOS End Of File mark (hex 1A) is converted to Apple End Of File (hex 00).

Random Access text files cannot be transferred.

When copying BINARY files from Apple DOS 3.3 to MS DOS

- a) The first two bytes of the Apple binary file, the start address", are removed.
- b) The second two bytes of the Apple binary file, the length of the binary me, are removed.
- c) The rest of the file is transferred without any conversion.

When copying BINARY file from MS DOS to Apple DOS 3.3

- a) Two bytes (HEX 00, HEX 10) are added at the beginning of the file. These indicate the start address (HEX 1000) of the binary file. The file will be loaded at the address HEX 1000.
- b) Two more bytes are added, indicating the length of the binary file.
- c) The rest of the file is transferred without any conversion.

## Apple ProDOS File Transfer

The ProDOS FILE Transfer Utility is kept on a TrackStore disk called FILETRAN. This TrackStore disk is contained on the Trackstar Utility Disk. You can use the SWITCH DISK command to access this program.

A copy of the Apple ProDOS Utility disk is required to run the Trackstar File Transfer Utility,

Before you can use the File Transfer Utilities you must first copy them to the 5.25" Apple ProDOS Utility Diskette.

The ProDOS File Transfer utility itself is composed of two programs; one program called TRANSFER and the other BTRANSFER. Both programs must be copied to the ProDOS Utility diskette before the File Transfer can begin. To copy the files from the FILETRAN disk to the disk in the Apple External or 360K Drive you should use the ProDOS Utility Disk supplied by Apple. Please refer to the manual accompanying the Apple ProDOS Utility Disk for complete instructions on file copy.

Before you begin, make sure that

- 1) The TRANSFER and BTRANSFER programs are on the ProDOS Utility diskette.
- 2) The External Apple or 360K Drive is configured as Apple Drive

## Starting the Program

Now that the FILE TRANSFER programs are on the ProDOS Utility diskette in drive D1 we are ready to begin.

You can start the ProDOS File Transfer Utility from within the Apple

ProDOS Utility Program

From inside the ProDOS Utility's FILER Menu select the **QUIT** option. When asked for a pathname, type **TRANSFER**, then press the <enter> key.

From within ProDOS BASIC you can type **BRUN BTRANSFER** then <enter> to start the File Transfer Utility.

The ProDOS File Transfer menu will appear on the screen: See Figure 8-3.

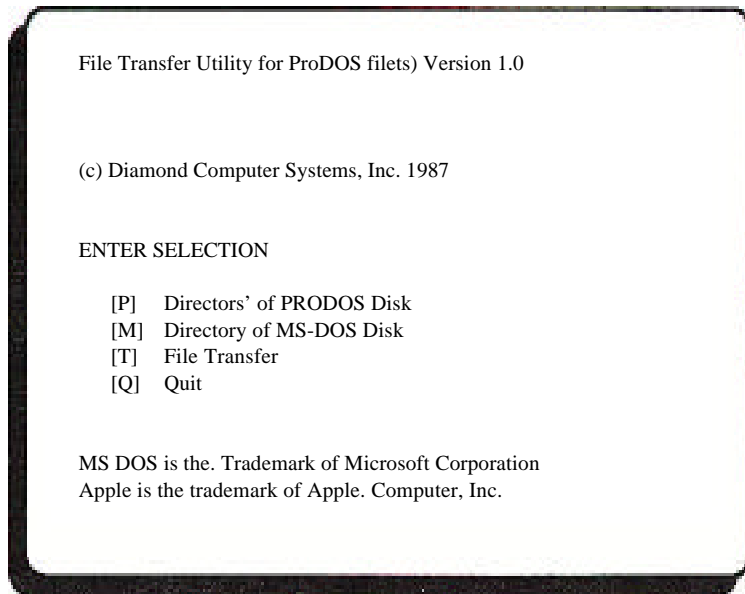

Figure 8-3

If you are copying data to MS DOS you should now place the Apple 5.25" diskette containing the information to be copied in the Apple External or 360K Drive. If you will be copying data from MS DOS place an empty, formatted diskette in the Apple External drive now.

Selecting Option [P] from this menu will display a catalog of all Apple programs contained on the Apple diskette in the External Apple Drive. You can use this option to verify that the programs you wish to transfer to MS DOS are on the disk. It can also be used after a file transfer from MS DOS to verify that the programs did transfer as expected.

Option [M] will perform the same function of on an MS DOS disk or volume. You will be asked to specify the letter of the MS DOS drive you wish to see a directory of.

Only files in the selected directory or subdirectory of the specified drive will be displayed. You cannot transfer files to or from a subdirectory other than the one currently selected in MS-DOS.

Option [Q] will exit the File Transfer Utility. You must re-boot from an Apple diskette when you exit the File Transfer Utility.

Option [T] will begin the file transfer process.



## ProDOS to MS DOS

Figure 8-4 is a composite screen composed of all of the questions to be answered during a ProDOS toMS DOS transfer. Each question will appear on the screen in order, from top to bottom.

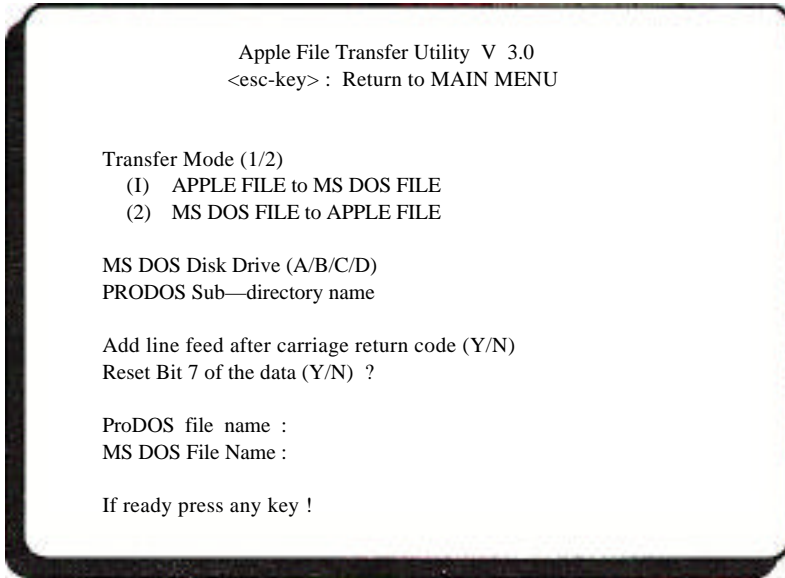

Figure 8-4

Note: at this time, an Apple diskette must be in Apple drive D1.

### Question A: **Transfer Mode (1/2)**

1. **PRODOS file to MS DOS file**
2. **MS DOS file to PRODOS file**

You may now specify in which direction the File Transfer will go. Entering 1 will copy files from the Apple diskette to an MS DOS disk. Entering 2 will transfer files from an MS DOS disk to an Apple diskette.

### Question B: **MS DOS Disk Drive (A/B/C/D):**

Please specify the drive that MS DOS files are going to be copied to or from. This can be any drive A,B,C,or D. You may use a hard disk, floppy disk, or file server as a MS DOS drive.

### Question C: **PRODOS Sub-directory name:**

If you wish to copy data to or from a ProDOS sub-directory on the diskette in the External Apple Drive you may enter the name of that sub-directory now. If you do not wish to use a sub-directory, press the <enter> key before making an entry.

Question D: **Add line feed after carriage return code (Y/N)**

This question, and the one following, are entirely application specific. In general, you should not add a line feed after carriage return, unless the destination program absolutely requires it.

Question E: **Reset bit 7 of the data (Y/N)**

Again the answer to this question is application specific. In general do not reset bit 7 of the data unless the destination program requires it.

If for any reason the transferred data appears unreadable, and there appears to be no reason for it to be so, then adding linefeeds and resetting bit 7 may be useful.

Question F: **ProDOS file name**

Enter the name of the ProDOS file to be transferred to MS DOS.

Question G: **MS DOS file name**

Enter the name that you want the destination file to be called. If you press the <enter> key here without specifying a filename then the first eight characters of the ProDOS file name will be used.

When ready press the <enter> key to begin the File Transfer. Pressing the <esc> key at any time will stop the transfer and return you to the File Transfer main menu.

MS DOS to ProDOS

Figure 8-5 is a composite screen composed of all of the questions to be answered during a ProDOS to MS DOS transfer. each question will appear on the screen in order, from top to bottom.

Note:at this time an Apple diskette must be in Apple drive D1.

Question A: **Transfer Mode (1/2):**

- 1. PRODOS file to MS DOS file**
- 2. MS DOS file to PRODOS file**

You may now specify in which direction the File Transfer will go. Entering 1 will copy files from the Apple diskette to an MS DOS disk. Entering 2 will transfer files from an MS DOS disk to an Apple diskette.

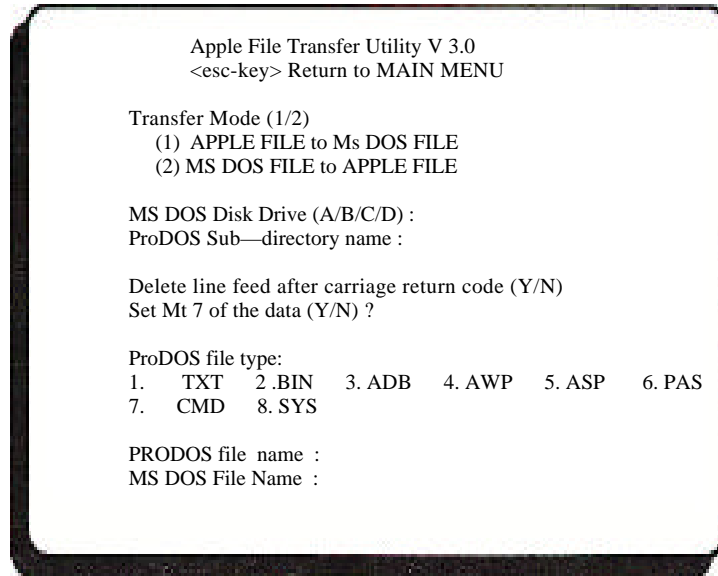

Figure 8-5

**Question B: MS DOS Disk Drive (A/B/C/D):**

Please specify the drive that MS DOS files are going to be copied to or from. This can be any drive A, B, C, or D. You may use a hard disk, floppy disk, or file server as a MS DOS drive.

**Question C: PRODOS Sub-directory name:**

If you wish to copy data to or from a ProDOS sub-directory on the diskette in the External Apple or 360K Drive, you may either the name of that sub-directory now. If you do not wish to use a sub-directory, press the <enter> key before making an entry.

**Question D: Delete Line feed after Carriage Return Code**

This question, and the one following, are entirely application specific. In general, you should not delete the line feed after carriage return unless the destination program absolutely requires it.

Question E: **Set bit 7 of the data (Y/N)**

Again, the answer to this question is application specific. In general, do not set bit seven of the data unless the destination program requires it.

If for any reason the transferred data appears unreadable, and there appears to be no reason for it to be so, then deleting line feeds and setting bit 7 may be useful.

Question F: **PRODOS file type:**

1. TXT
2. BIN
3. ADB
4. AWP
5. ASP
6. PAS
7. CMD
8. SYS

You must specify the type of file that you want the transferred ProDOS file to be. In practice you will only select type 1 TXT (text) or type 2 BIN (binary). Selecting any other file type will result in an unusable file.

Question G: **MS DOS filename:**

Enter the name of the MS DOS file to be transferred.

Question E: **PRODOS file name:**

Enter the name that you want the destination file to be called. If you press the <enter> key here without specifying a filename, the MS DOS file name will be used.

When ready, press the <enter> key to begin the File Transfer. Pressing the <esc> key at any time will stop the transfer and return you to the File Transfer main menu,

---

APPENDIX A:

Trackstar E Installation Procedure

This section contains diagrams of the components that will be used for the installation. These diagrams should be studied carefully both before and during the installation process. Familiarity with each part will help significantly in installing the board.

Before you begin installation, the workspace should be clean and all the necessary parts and tools should be assembled. Please observe the following precautions:

- o **All power to the computer should be turned off.**
- o **All cables should be disconnected.**
- o **All diskettes should be removed from the area.**

Each step of the installation should be followed carefully.

The following parts are included with your Trackstar *E*

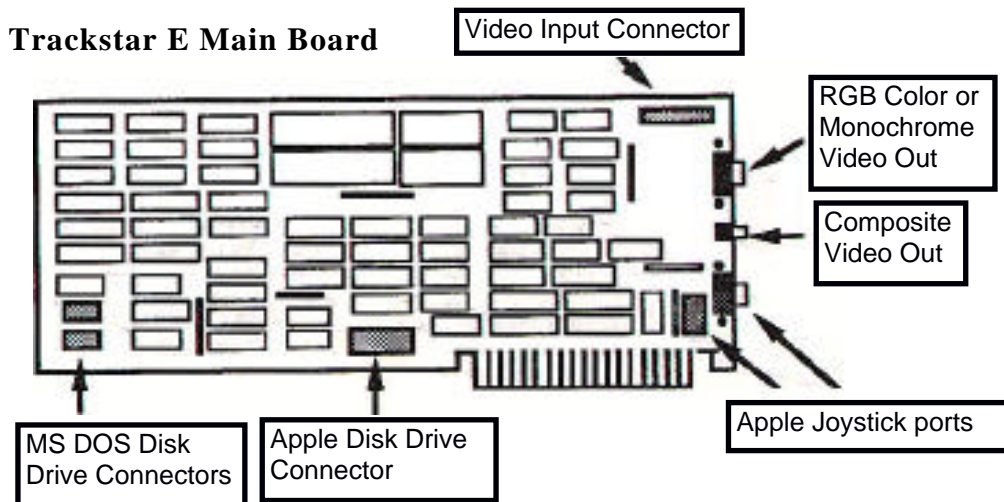
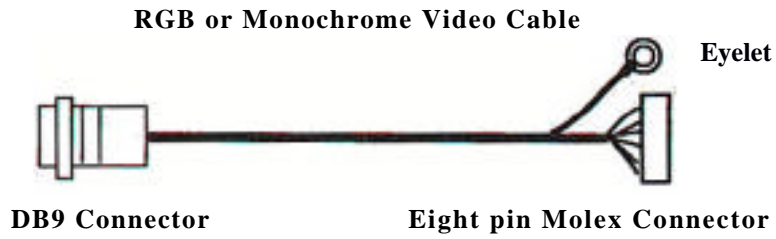

Figure 1

**Video Adaptor Cables**



**Figure 2**

**Disk Adaptor Cable**

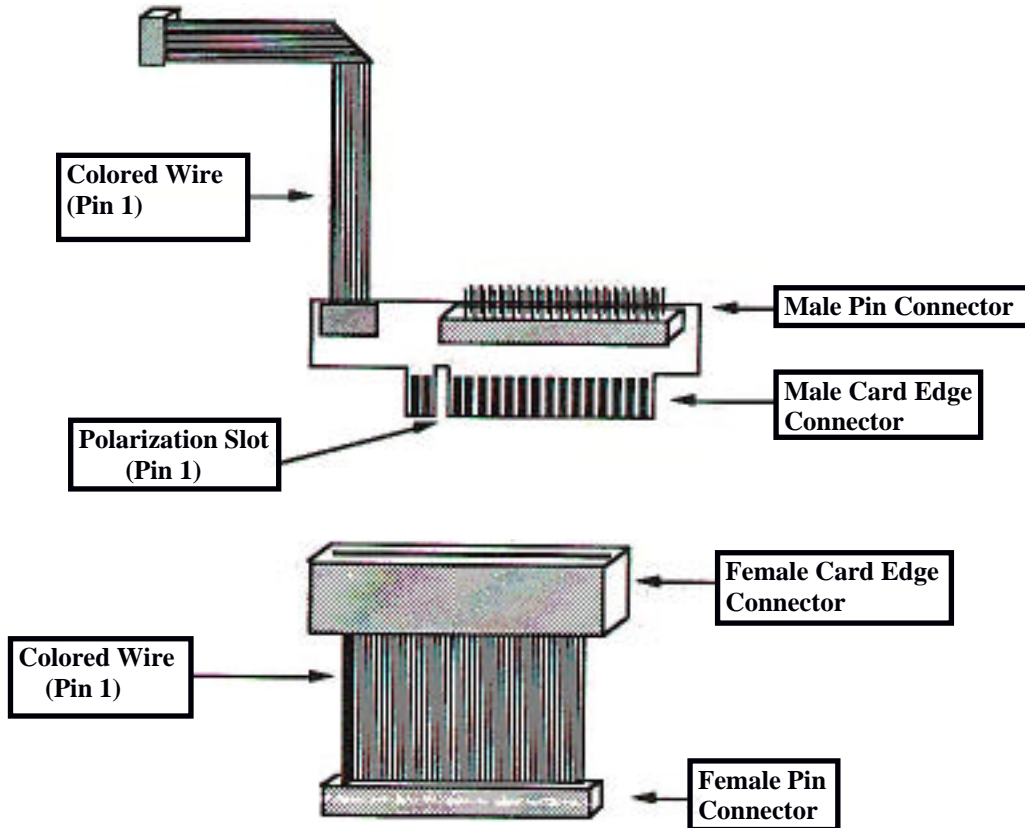

**Figure 3**

## The Installation Procedure

### Pre-Installation Check:

- I. Before beginning these steps, please check to see that all power cords are disconnected, and all peripheral devices (such as printers, disk drives, etc.) are turned off and unplugged from the computer.
2. Refer to the owners manual for your computer for instructions on opening the case.
3. With the case open locate an empty slot for the Trackstar. Ideally, the Trackstar will be located in an eight-bit slot that is one slot away from the disk controller card (if present). This will leave room for the various adaptor cables, Do not insert the Trackstar into your system yet.

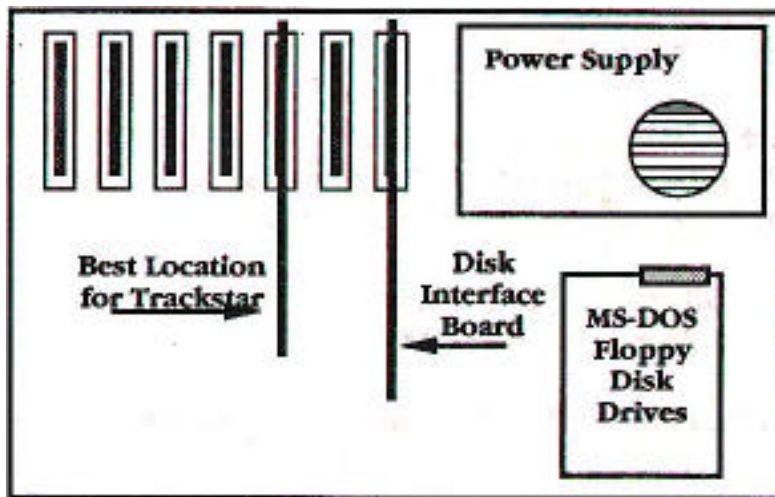

Figure 4

### Installing the disk adaptor cable

The Trackstar Disk Adaptor Cable connects your Trackstar E to the 360K MS DOS disk drive(s). Its presence allows the 360K drive(s) to read and write Apple floppy diskettes. This will in no way interfere with the operation of the 360K drive(s) under MS DOS.

*Note: 1.2Mb 5.25" disk drives cannot read Apple diskettes- even if they are capable of reading MS DOS 360K software.*

Do not install this cable if you have no 360K drive(s). If you have an External Apple Disk Drive to connect to the Trackstar and do not want to read Apple diskettes with your 360K disk drive(s), then installation of this cable is optional.

The Trackstar Disk Adaptor Cable will be connected between your 360K disk drive(s) and the disk controller card,

If you have a disk drive other than a 560K drive installed as drive A:, you must follow installation Procedure "A".

If you have one 360 K drive installed as drive A: then you may follow installation Procedure "A" or "B". If you have two 360K drives use Procedure 'B' Only. Read both Procedures completely before deciding which is best for your system.

### **Trackstar E Disk Adaptor Cable Installation Procedure A.**

Refer to Figure 3. You will notice that the Disk Adaptor Cable is composed of two parts. The cable is shipped with both parts plugged together such that male and female 34 pin moxex connectors are exposed.

Grasping the small green PC board in one hand and the attached wide gray connector in the other, gently separate the two halves of the Adaptor Cable.

Now connect the male and female moxex connectors together as shown in Figure5.

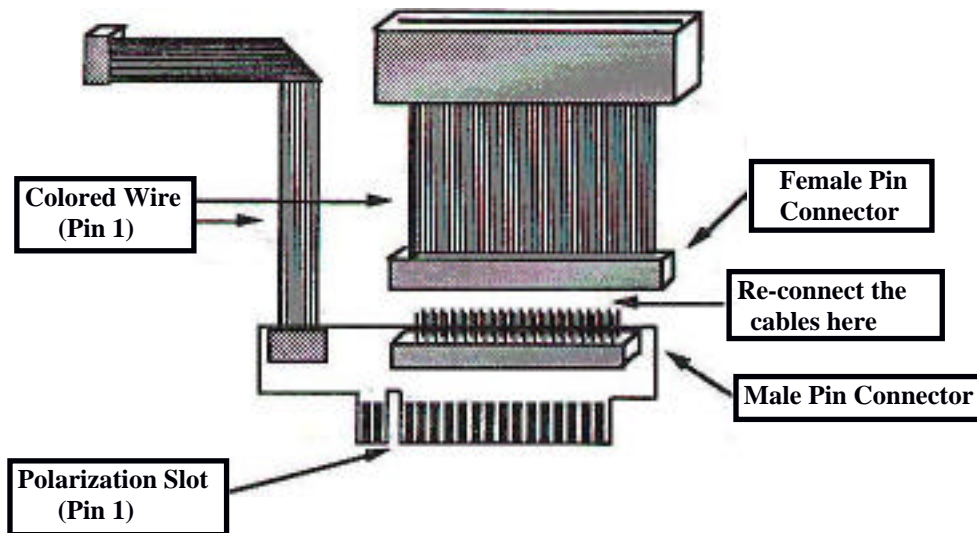

Figure 5



The colored wire (pin 1) on the wide cable **MUST** be on the same side of the connector as the colored wire on the long narrow cable.

Locate the ribbon cable that connects your disk drives to their controller. The controller may be a separate card or it may be built directly into the motherboard.

Carefully disconnect this cable from the back of your 360K disk drive. Note the position of the colored wire on the edge of the cable (pin 1). See Figure 6.

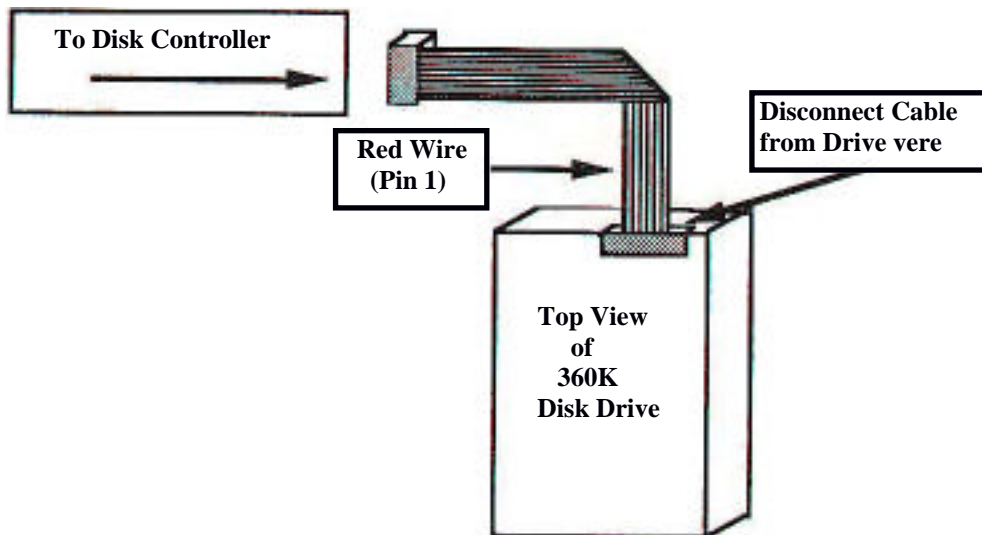

Figure 6

*If you have two 360K disk drives then disconnect the cable from the back of Drive A:*

Take the Trackstar Disk Adaptor Cable and connect the female edge connector to the back of the disk drive. Make sure the colored wire (pin 1) is on the same side as it was on the cable you removed. See Figure 9.

Take the cable you previously disconnected from the disk drive and attach it to the male edge connector on the Trackstar Disk Adaptor Cable. The colored wire from the adaptor cable should be on the same side as the colored wire on the drive cable.

You have now installed the Trackstar Disk Adaptor Cable between your 360K drive(s) and the cable coming from the disk controller.

Next the long, narrow cable must be connected to the Trackstar. Please refer to the section on **Connecting the Disk Adaptor Cable to your Trackstar** for this information.

## Trackstar E Disk Adaptor Cable Installation Procedure B

Locate the ribbon cable that is connected to your floppy disk drives. Follow this cable to its connection point on a disk controller card or to the motherboard of your PG.

Refer to Figure 7. This figure is a composite picture of a disk controller board. The cable from the disk drives will be connected to either a set of pins on the top of the board or to an edge connector on one side of the board.

### Example MS DOS Disk Controller

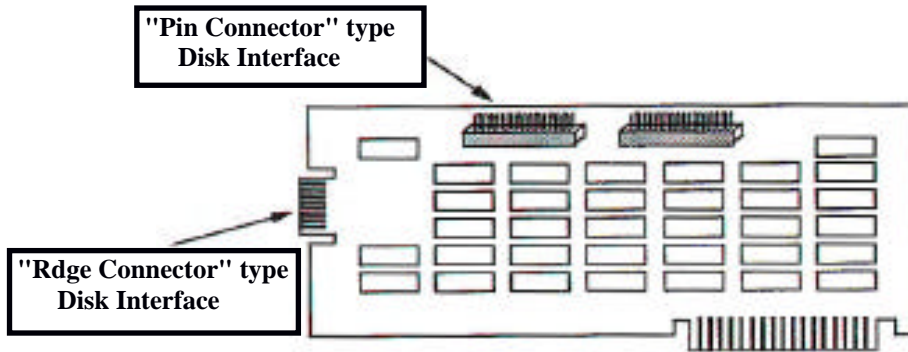

Figure 7

The same is true if the cable is connected to the motherboard of the PC. It will terminate in either a double row of pins or an edge connector,

If the connection point is a pin (or molex) type connector then skip forward to **Connecting the cable to the disk controller.**

If the connection point is an edge connector then you must re-configure the Trackstar Disk Adaptor Cable.

Refer to Figure 3, You will notice that the Disk Adaptor Cable is in two parts. The cable is shipped with both parts plugged together such that male and female 34 pin molex connectors are exposed.

Grasping the small green PC board in one hand and the attached wide gray connector in the other, gently separate the two halves of the Adaptor Cable.

Now connect the male and female molex connectors together as shown in Figure 5.

The colored wire (pin 1) on the wide cable **MUST** be on the same side of the connector as the colored wire on the long narrow cable,

### Connecting the cable to the disk controller

Again, locate the connector where the ribbon cable from your disk drive(s) is attached to the disk controller board or motherboard.

Gently remove this cable from the controller.

If the Trackstar Disk Adaptor Cable has been configured correctly it can now be inserted between the MS DOS disk controller and the cable you have just removed. Refer to Figure 8 for a PIN type connector or refer to Figure 9 for an EDGE type connector.

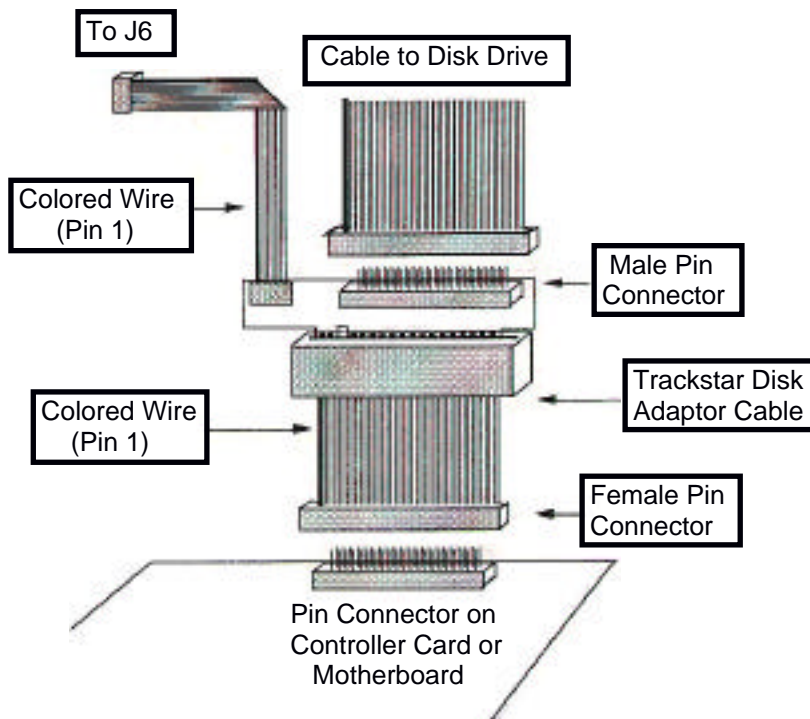
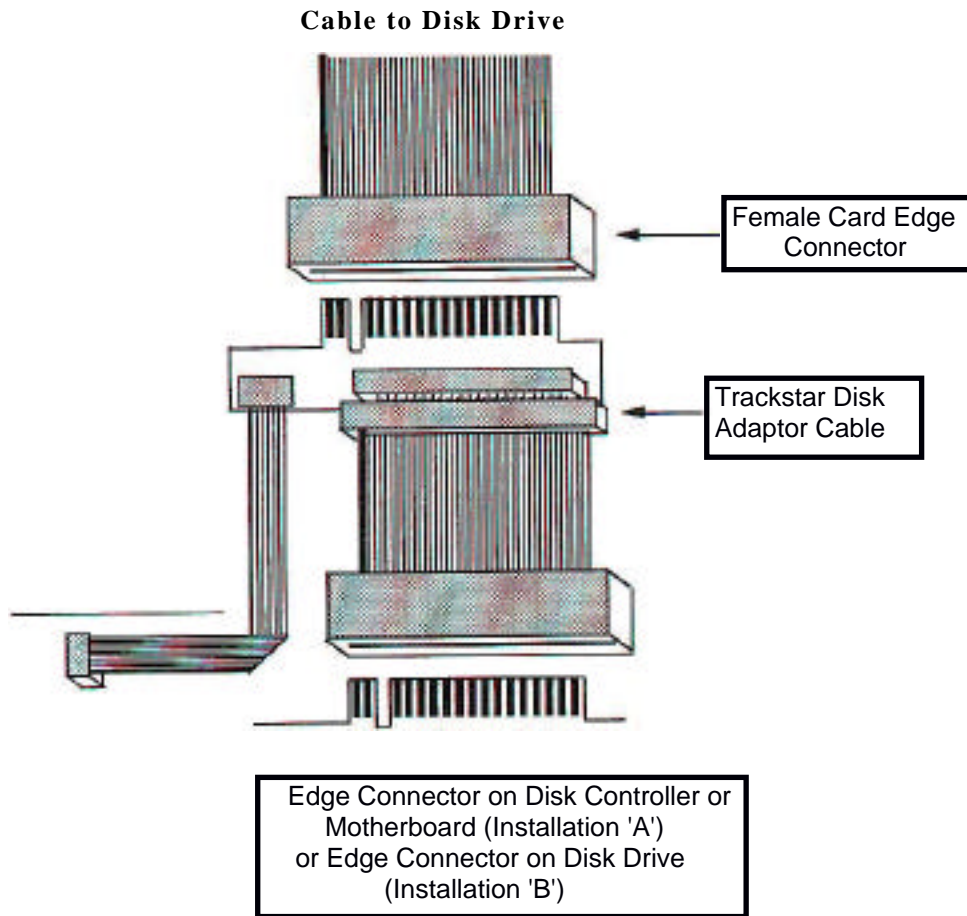

Figure 8

Remember to keep the colored wires on the same side of each cable.



**Figure 9**

**Connecting the Disk Adaptor Cable to the Trackstar.**

You will notice that a long narrow ribbon cable is attached to the Trackstar Disk Adaptor Cable. This narrow ribbon cable attaches to a connector on the lower left hand corner of the Trackstar.

There are two possible attachment points for the cable. These connectors are labeled J5 and J6 on the Trackstar main board. See Figure 10.

If you used installation procedure "A" then attach this narrow cable to connector J6 on the Trackstar.

If you used installation procedure "B" then refer to Figure 7. This Figure is a composite picture of a disk controller board. The cable from your MS DOS disk drives attach to your controller card or motherboard either with an edge type connector or a pin (molex) type connector.

### Trackstar E Main Board

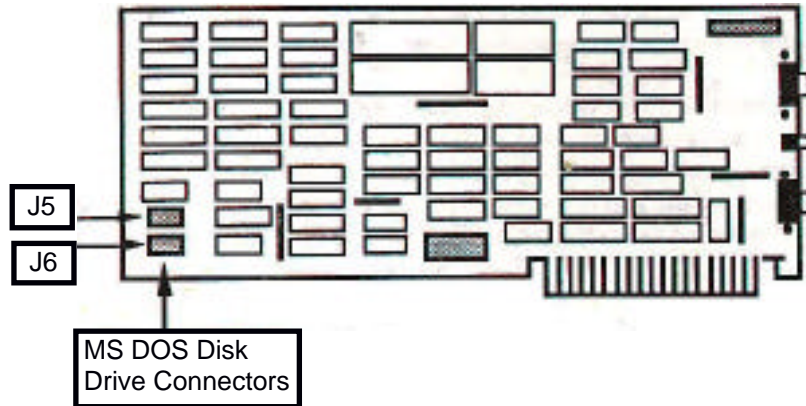

Figure 10

If the cable from your MS DOS disk drive connects to the disk controller by way of an EDGE type connector, then you should connect the narrow ribbon cable to location **55** on the Trackstar main board.

If the cable from your MS DOS disk drive connects to the disk controller by way of a PIN (molex) type connector, then you should connect the narrow ribbon cable to location J6 on the Trackstar main board,

You have now completed the Disk Adaptor Cable Installation!

### Trackstar E Main Board

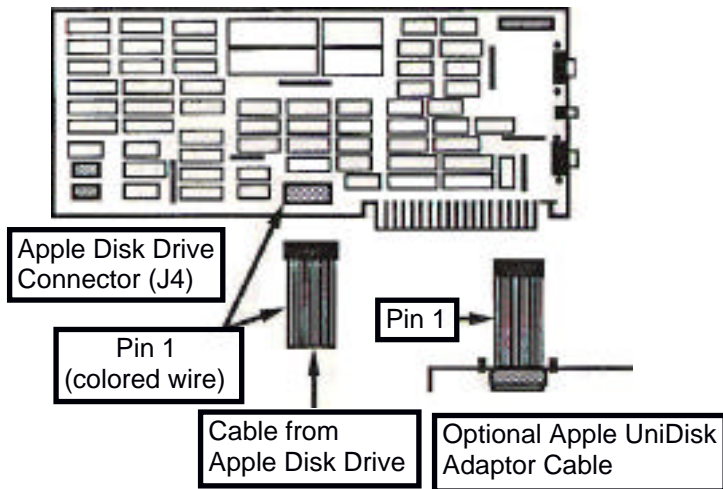

Figure 11

### Attaching the Optional Apple Disk Drive:

You Trackstar has a connector for attaching an Apple compatible 5.25" disk drive directly to the Trackstar main board. See Figure 11.

Apple compatible disk drives may have one of two different kinds of connector. The most numerous drive, those built for the Apple II and lie have a small 20 pin rectangular molex connector on the end of the disk drive cable. Disk drives built for the Apple //c are equipped with a 19 pin oval 'D' type connector on the end of the drive cable. See Figure 12.

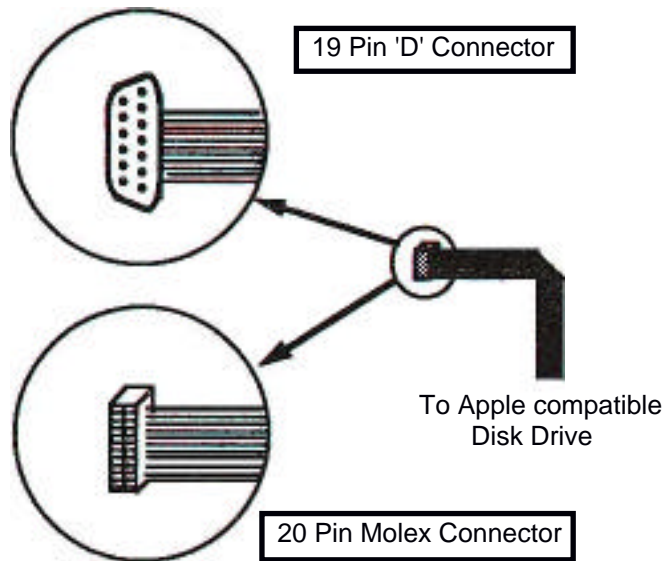

Figure 12

Disk drives equipped with the 20 pin molex style connector may be connected directly to the Trackstar main board at location J4.

Thread the Apple compatible drive cable through an empty slot in the back of your computer and gently attach it to the Trackstar. Refer again, to Figure 11 for the proper orientation of the cable. One edge of the cable has a colored stripe on it- this colored edge MUST go to the left as you face the Trackstar.

#### Warning!

*The cable is not keyed" so it is physically possible to plug it on backwards. Connecting Ibis cable backwards will damage the disk drive and possibly the Trackstar as well!*

If your Apple compatible drive is equipped with the 19 pin 'D' style connector you will need an adaptor cable, This adaptor cable is available from your dealer or Diamond Computer Systems.

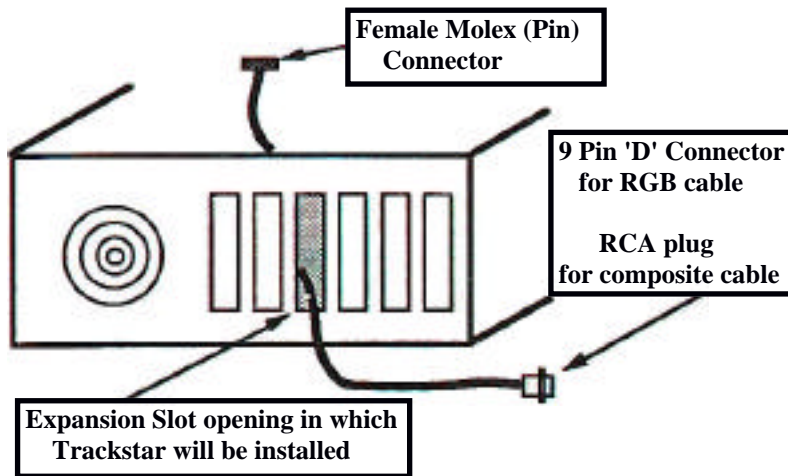

Figure 13

### Attaching the Video Cables

Refer to Figure 2 and select the video cable that matches your monitor:

Color or TTL Monochrome Monitor Select the RGB or Monochrome Video Cable.

Composite Monitor: Select the Composite Video Cable.

Locate the expansion slot in the rear of the PC where the Trackstar is to be inserted. Thread the female molex (pin) connector through the opening of the expansion slot in the rear of the computer. See Figure 13

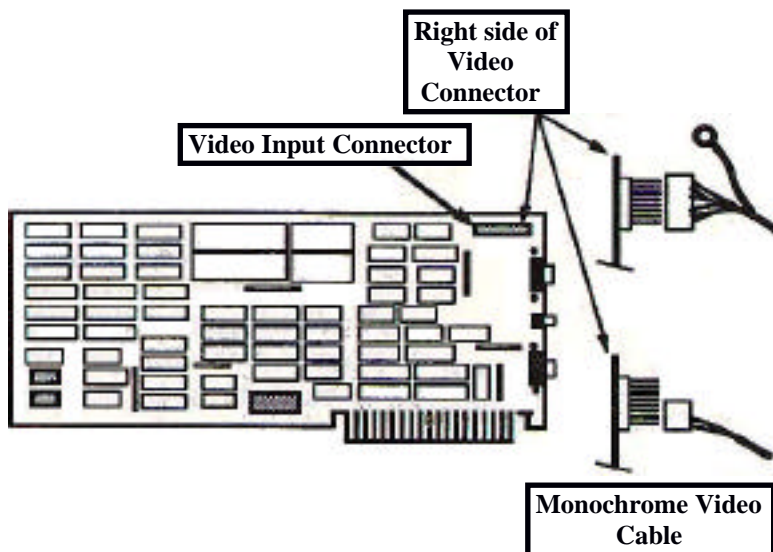

Figure 14

Attach the female moxex connector to the Trackstar Video Input connector as shown in Figure 14.

You are now ready to install the Trackstar board into your computer.

### Trackstar E Main Board

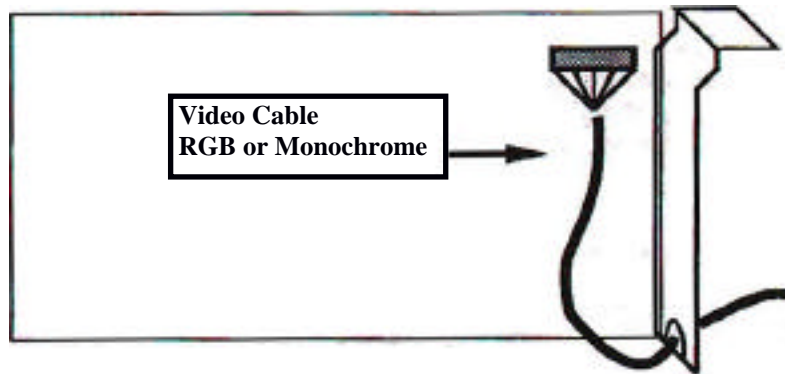
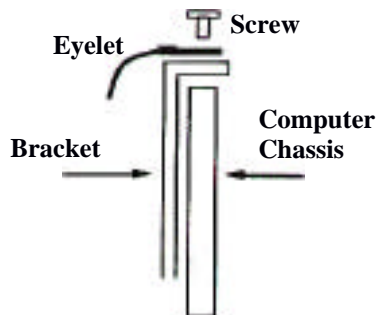

Figure 15

### Installing the Trackstar Board

Locate the metal shield attached at the back of the Trackstar. Notice that this metal shield has an oval cutout at the bottom, See Figure 15, The video cable that you just attached to the Trackstar will exit the computer through this notch.

The video cable has a narrow metal band circling it four inches from the end. Center this metal band in the notch as you insert the Trackstar into the expansion slot



The RGB color video cable has a small metal eyelet at the Trackstar end. Fasten the Trackstar and the eyelet to the back panel of the computer using the screw that held the blank metal plate in place. See Figure 16

Note: The Composite Video Cable does not have an eyelet or the small metal ring.

Figure 16



## Attaching the monitor

There is one last step to perform before closing up the computer. On the outside of your machine locate the video out connector. This connector is the one the monitor was attached before the Trackstar was installed.

Connect the Video Adaptor Cable from the Trackstar to the Video out port on the computer.

Next, take the video cable from the monitor and connect it to the Trackstar board.

An RGB color or TTL monochrome cable will connect to the TOP 9 pin 'D' connector on the Trackstar board.

A Composite monitor will connect to the RCA plug centered on the back of the Trackstar board. See Figure 17.

NOTE: The BOTTOM 9 pin 'D' connector on the back of the Trackstar board is for an Apple Joystick ONLY! Connecting a monitor to this port may cause severe damage to the monitor!

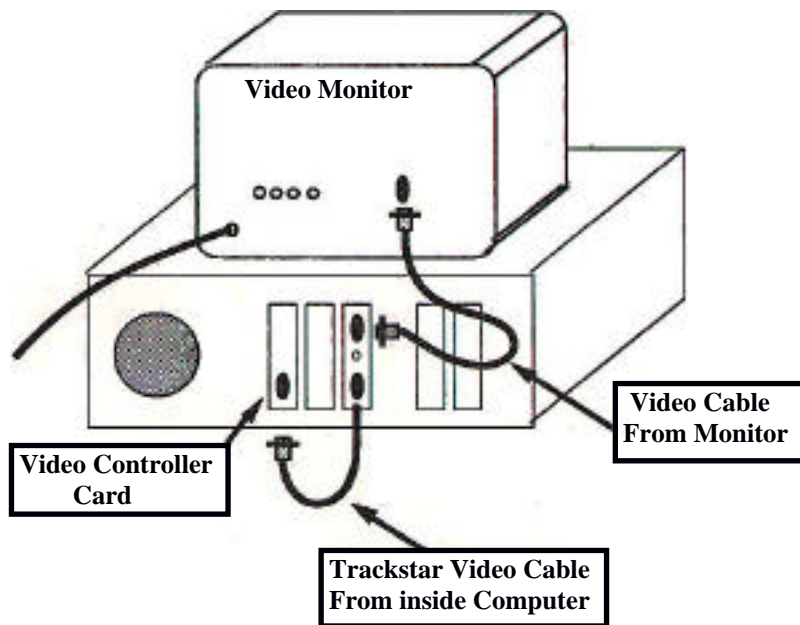

Figure 17

You have completed the Hardware installation. Return now to Chapter Three to continue the installation.