

# PCI/I-486SP3G

*PCI Bus Mainboard*

*With On Board PCI SCSI Controller and Super Mu*

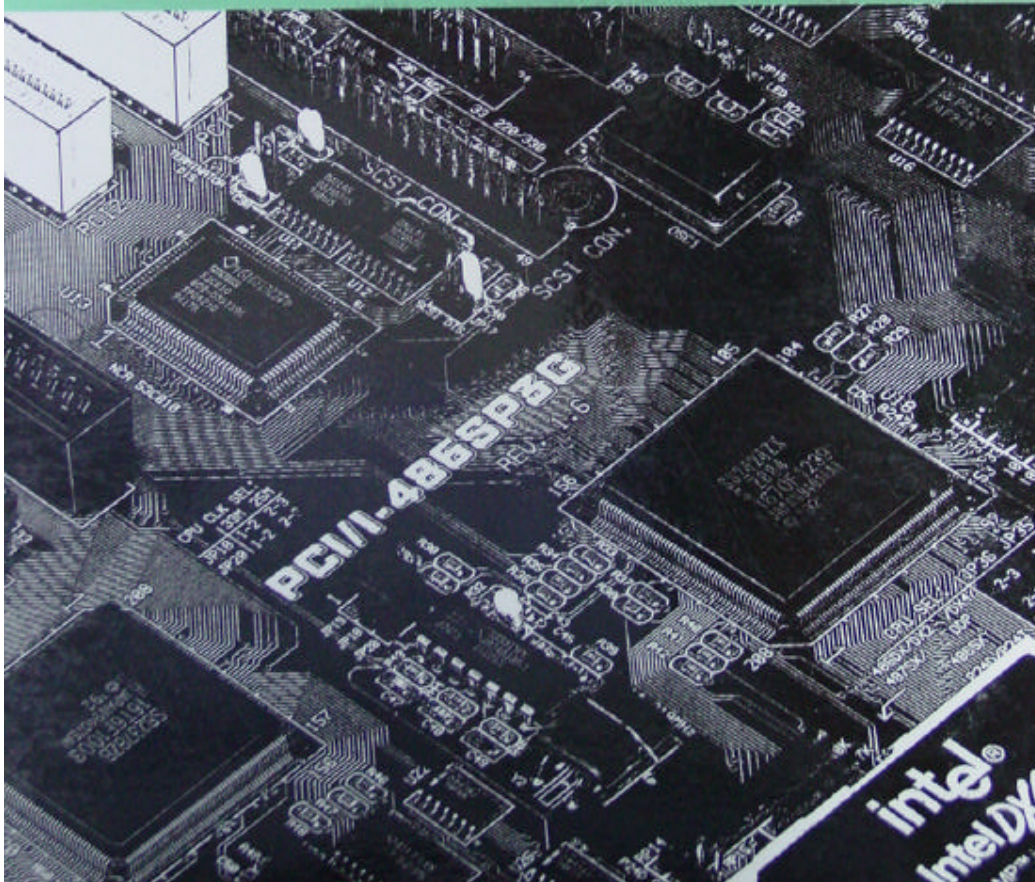

## Technical Summary

The first part of this section summarizes the mainboard's specifications. The second part explains how to set up the optional PCI-SCSI Interface card.

### Jumper Setting Summary

#### ISA/PCI IRQ Assignments: JP1 – JP10

These assign IRQs to either the ISA slots (default) or to PCI slots with edge-triggered cards installed. Don't use these for level-triggered cards. Use the PCI Slot Configuration section in the BIOS Setup program for level-triggered cards.

	PCI1	PCI2	PCI3
<b>IRQ5</b>	JP1, 1&2	JP1, 3&4	JP6, 1&2
<b>IRQ9</b>	JP2, 1&2	JP2, 3&4	JP7, 1&2
<b>IRQ11</b>	JP3, 1&2	JP3, 3&4	JP8, 1&2
<b>IRQ14</b>	JP4, 1&2	JP4, 3&4	JP9, 1&2
<b>IRQ15</b>	JP5, 1&2	JP5, 3&4	JP10, 1&2

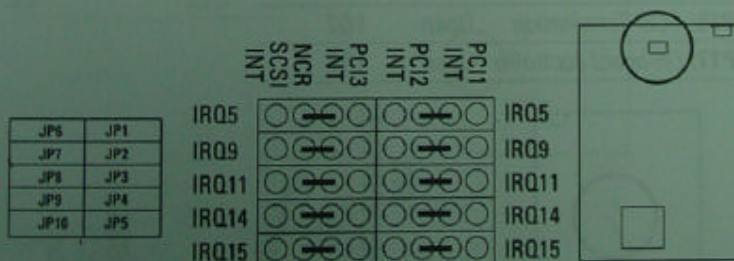





# PCI/L-486SP3G User's Manual

## DMA Channel: JP11 – JP12

These select the DMA channel for the on-board ECP (Extended Capabilities Parallel Port). The default is DMA 3.

	JP11	JP12
<b>DMA 1</b>	1&2	1&2
<b>DMA 3</b>	2&3	2&3

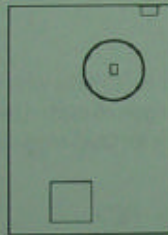

## On-board SCSI Control: JP16 – JP17

JP16 controls the on-board SCSI terminators. Terminators must be enabled if the on-board controller is in use. JP17 controls the on-board SCSI controller. Disable the NCR controller if you install an alternate SCSI controller card.

	Enable	Disable
<b>JP16: SCSI Termination</b>	Open	1&2
<b>JP17: On-board controller</b>	Open	1&2

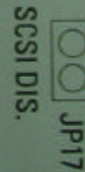
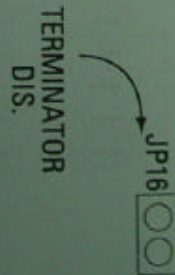
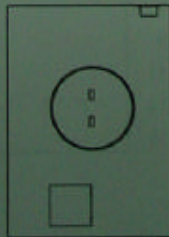

**CPU External Clock Selector: JP18 & JP20**

Set this according to the *external* clock speed of the installed CPU.

	JP18	JP20
25MHz	2&3	2&3
33MHz	1&2	1&2

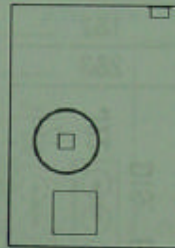
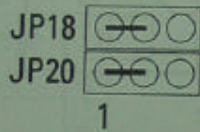

**BIOS Flash Memory Voltage Selector: JP21**

This is factory-set to the 5V setting. See the FMW section in Chapter 3 for more information on this.

	JP21
12V	1&2
5V	2&3

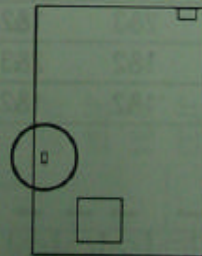
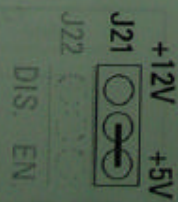

**PS/2 Mouse Interrupt: JP22 (IRQ12)**

If the PS/2 mouse option is present and in use, you must enable this.

	JP22
Disable	1&2
Enable	2&3

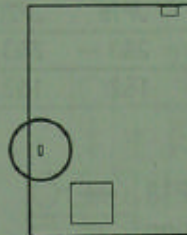
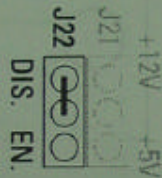

**Level 2 Cache Size: JP26 – JP29**

These are set based on the size of the cache installed.

	JP26	JP27	JP28	JP29
128K	2&3	1&2	2&3	2&3
256K	1&2	2&3	1&2	2&3
512K	1&2	1&2	1&2	1&2

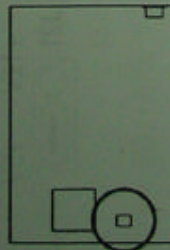
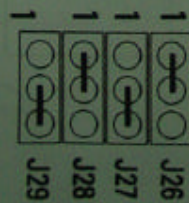



## CPU SL Selector: JP30 – JP32

Set according to the installed CPU type.

**Note:**

The Intel 486DX4™ is an SL-Enhanced CPU

	JP30	JP31	JP32
Non-SL CPU	2&3	1*	1*
SL CPU	1&2	1&2	1&2

*AMD D4-100 CPU*



Non-SL

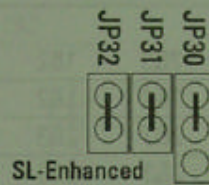

SL-Enhanced

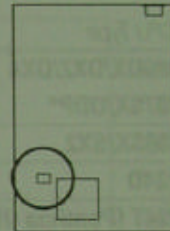

## CPU Internal Clock Selector: JP33

Set this according to the internal clock speed of the Intel 486DX4™ CPU installed. 75MHz uses x3. 100MHz uses x3. For SX, DX and DX2 CPUs keep this open. Future CPUs of the Intel 486DX4™ type will also use this jumper.

	JP33
x 2	2&3
x 2.5	1&2
x 3	open

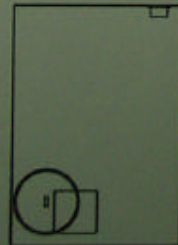
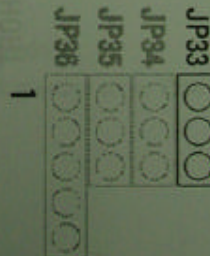

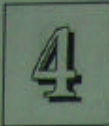

## PCI/I-486SP3G User's Manual

### CPU Type Selectors: JP34 – JP36, JP38

These jumpers indicate the type of CPU installed. Note that there is more than one kind of OverDrive Processor (ODP). The jumpers will be set for the CPU currently installed on the mainboard. If you install a CPU upgrade, make sure to use the setting for the new CPU as noted here.

CPU Type	JP34	JP35	JP36	JP38
<b>486DX/DX2/DX4</b>				
<b>487SX/ODP*</b>	2&3	1&2	2&3	Open
<b>486SX/SX2</b>	1&2	1&2	2&3	Open
<b>P24D</b>	2&3	2&3	1&2,4&5	Short
<b>P24T (Pentium ODP*)</b>	2&3	2&3	1&2,4&5	Open

\*ODP = OverDrive Processor

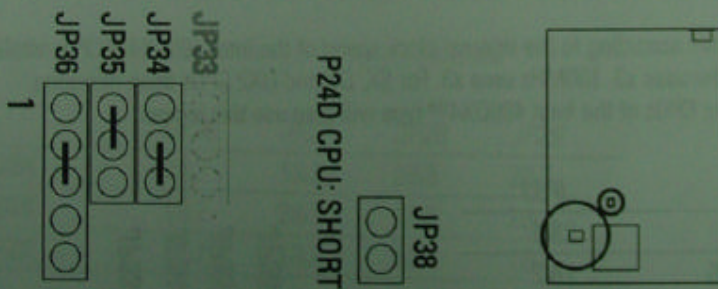

## Intel DX4/Cyrix DX2-V Voltage Selection: JP40

This jumper selects the CPU voltage for these two CPUs. The Intel CPU uses 3.45 volts and the Cyrix CPU uses 3.6 volts, so you must make sure that these jumpers are set correctly. The default setting is for the Intel CPU, so you do not need to change the setting if you do not install a Cyrix DX2-V.

Clock Speed	JP40
Intel DX4 (default)	2&3
Cyrix DX2-V	1&2

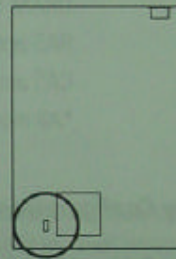

Intel DX4, 3.45-volt    Cyrix DX2-V, 3.6-volt

## CPU Options

- Any Intel 486 CPU.
- SL CPUs must be Intel.
- Non-SL 486-compatible CPUs from other vendors.

All CPU options must run at an external clock speed of either 25MHz or 33MHz.



## Memory Subsystem

### DRAM Specifications:

Module Size: 1MB, 2MB, 4MB, 8MB, 16MB, or 32MB

DRAM Mode: Fast Page Mode

DRAM Speed: 70ns (or faster)\*

RAS access time [Trac]: 60ns - 70ns

CAS access time [Tcac]: 10ns - 25ns

\*All modules must be the same speed.

### Memory Configuration Options

See pages 2-10 and 2-11 for chart.

### Level 2 Cache Options

SRAM speed required: 20ns.

Cache Size	Installed SRAM Chips		
	Bank 0	Bank 1	Tag
<b>128KB</b>	Four 32K x 8		One 8Kx8
<b>256KB</b>	Four 32K x 8	Four 32K x 8	One 32Kx8
<b>512KB</b>	Four 128K x 8		One 32Kx8

Level 2 Cache SRAM Sockets

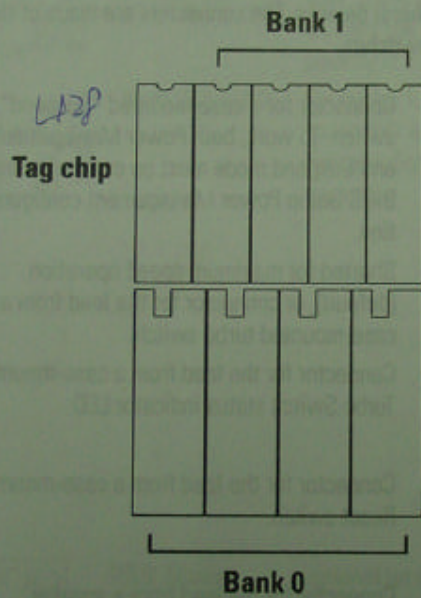



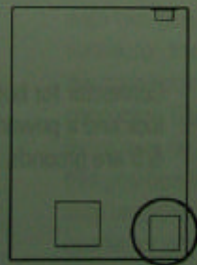

Bank 0 is made up of dual sockets that accept the larger cache chips used in the 512KB cache



**Connectors:**

There are several connectors on the board for switches and indicator lights from the system case or installed peripheral devices. The connectors are made of the same components as the jumper switches.

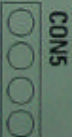
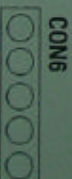
	<b>SMI_SW</b> CON1	<b>SMI_SW</b> Connector for a case-mounted "Suspend" switch. To work, both Power Management and Suspend mode must be enabled in the BIOS Setup Power Management configuration.
	<b>Turbo Switch</b> CON2	<b>Turbo Switch</b> Shorted for maximum speed operation (default), or connector for the lead from a case-mounted turbo switch.
	<b>Turbo LED</b> CON3	<b>Turbo LED</b> Connector for the lead from a case-mounted Turbo Switch status indicator LED.
	<b>Reset Switch</b> CON4	<b>Reset Switch</b> Connector for the lead from a case-mounted Reset switch.
	<b>Speaker</b> CON5	<b>Speaker</b> Connector for the lead from a speaker mounted inside the system case.
	<b>KeyLock</b> CON6	<b>KeyLock</b> Connector for both a case-mounted keyboard lock and a power-on LED. Pin 1 is live, pins 3 & 5 are grounds.





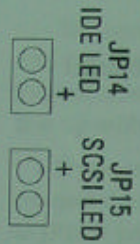

**JP14 IDE LED**

Connector for an IDE hard disk drive activity light. If you install an IDE hard disk drive, connect the indicator light lead here. The polarity is marked.

**JP15 SCSI LED**

Connector for a SCSI device activity light. If you install a SCSI device, connect the indicator light lead here. The polarity is marked.

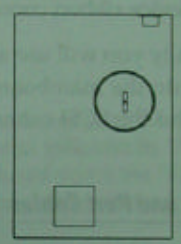

**PS/2 Mouse**

Optional (at manufacture) 6-pin connector for a cable to an external case-mounted PS/2 mouse port. The connector is an 8-pin block with two pins removed to orient the female connector from the mouse port. If installed, the connector is beside the keyboard connector. Depending on the model you have, there may be a PS/2 mouse port mounted in this position instead. The keyboard connector may be either a standard (larger) DIN connector or a mini-DIN PS/2 keyboard port.

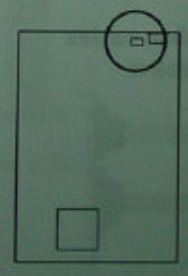

### Port & Controller Cables

The mainboard comes with the following cables:

- 2 serial port ribbon cables attached to one mounting bracket
- 1 parallel port ribbon cable with mounting bracket
- 1 IDE hard disk ribbon connector cable
- 1 floppy disk drive ribbon connector cable
- 1 SCSI device ribbon connector cable

Normally you will use at least the I/O ports and floppy controller built onto the mainboard. You can use the IDE hard disk drive interface and the SCSI connection at the same time.

### Connector and Port Cables

#### IDE ribbon cable

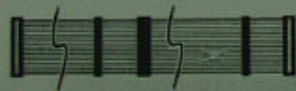

#### Parallel ribbon cable

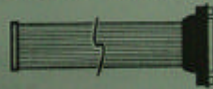

#### Floppy ribbon cable

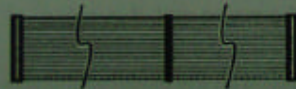

#### Serial ribbon cables & port bracket

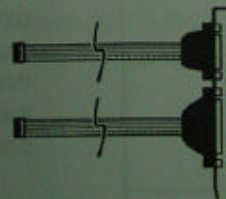

#### SCSI ribbon cable

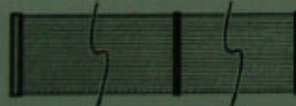

**SCSI, FDD, & IDE Interfaces**

The mainboard has connectors for ribbon cables to SCSI, FDD, and IDE devices. Each of these connectors is labeled to indicate its Pin 1 location. Remember, the colored edge of the ribbon cable must line up with Pin 1 for that connector.

If you are attaching a ribbon cable for a SCSI device, you should connect the SCSI LED connector to JP15. Connect an IDE HDD LED to JP14 if you are using the IDE HDD interface.

**SCSI, Floppy & IDE Connectors**

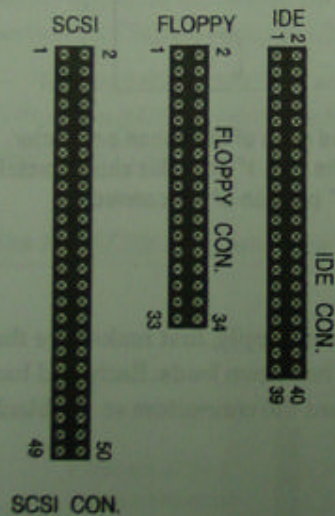

The shaded edge of the ribbon connector indicates its "Pin 1" line. This should match the "Pin 1" position of the connector.

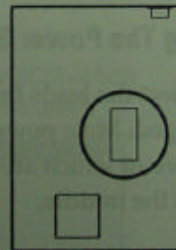



### Serial and Parallel Interfaces

The mainboard connectors for the two serial ports and the parallel port are similar to that of the SCSI interface. Each connector's Pin 1 location is also indicated. The colored edge of each connecting cable must be on the Pin 1 side of the connector.

#### Parallel, & Serial Connectors

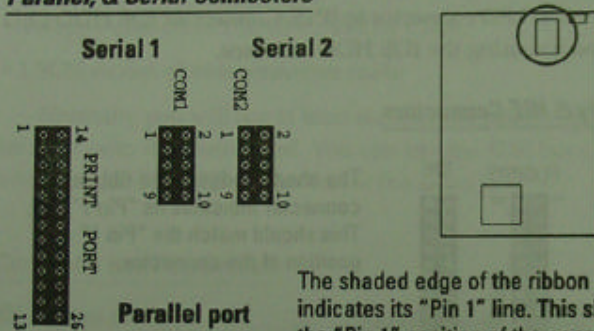

The shaded edge of the ribbon connector indicates its "Pin 1" line. This should match the "Pin 1" position of the connector.

### Connecting The Power Supply

To connect the leads from the power supply, first make sure the it is unplugged. Most power supplies have two leads. Each lead has six wires, two of which are black. Orient the connectors so the black wires are in the middle.

#### Power supply connectors

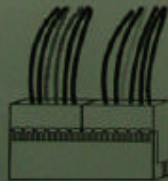

The black wires should be in the middle.

**The PCI-SC200 SCSI Interface Card**

This mainboard can use an optional SCSI interface card, the PCI-SC200, to connect both internal and external devices to your system. The card works with the SCSI BIOS on the mainboard. The card interface has the same features as the on-board SCSI interface with the addition of the external connector. If you install the PCI-SC200 it will function as a second SCSI bus. This means you can connect devices to both the on-board connector and the card. Alternatively, you can connect all devices to the card only.

To use the PCI-SC200, you must also enable the "NCR SCSI Firmware" option in the Award BIOS Setup Utility program. Refer to the section on Chipset Setup in Chapter 3 for more about this.

To install the PCI-SC200, you need to set it up first. The setup procedure is explained here. The basic card installation procedure is explained in Chapter 2.

**The PCI-SC200 SCSI Interface Card**

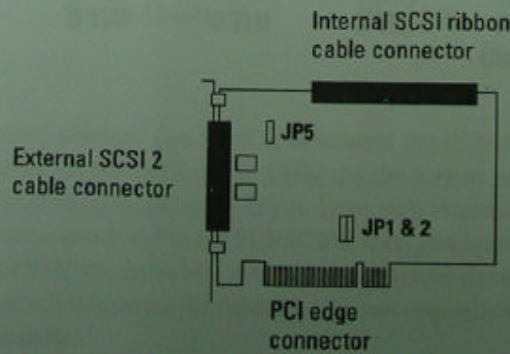

### Setting Up the PCI-SC200

There are two jumper settings you may need to make on the card to set it up. One setting assigns the PCI INT interrupt, the other sets the card's termination.

#### Setting the INT Assignment

As explained in Chapter 2, any PCI card you install must have PCI INT A assigned to it. On the PCI-SC200, you assign the INT by setting jumper JP1 or JP2. The default setting for the card is INT A. The INT assignment must be the same as the INT assigned to the PCI slot you install the card in, which for this mainboard is INT A.

The INT assignment jumper settings are illustrated below. The settings are printed on the card for your convenience.

#### JP1 & 2: Interrupt settings

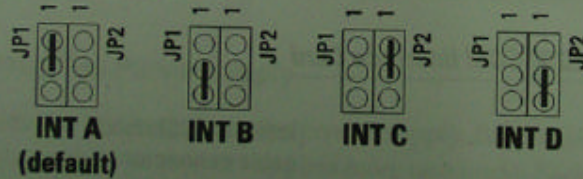



**Terminator Settings**

SCSI devices are connected together in a "chain" by cables. Internal devices connect to the PCI-SC200 with a fifty-pin flat ribbon cable. External devices connect to the external port with a SCSI-2 cable. If there is more than one internal or external device, additional devices are connected with cables to form a "daisy chain." The SCSI chain must be "terminated" at both ends, or the devices in the chain will not work properly. Many SCSI devices use a set of three terminating resistors to terminate the device. The PCI-SC200 has "active" termination that you set using jumper JP5. If you need to terminate the PCI-SC200, you do it by setting the jumper. The two settings, terminated and unterminated, are shown below.

**JP5: Terminator setting**

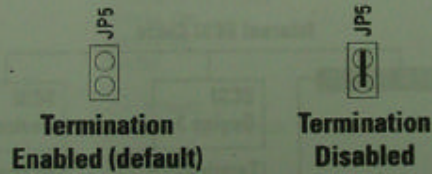

Decide whether you need to terminate the PCI-SC200 based on its position in the SCSI chain. Only the devices at each end of the chain need to be terminated. If you have *only* internal or *only* external devices connected to the PCI-SC200, then you *must* terminate the PCI-SC200. If you have *both* internal and external devices connected, you *must not* terminate the card. The figures opposite illustrate these requirements.



# PCI/I-486SP3G User's Manual

## Example 1: Only internal or only external devices connected

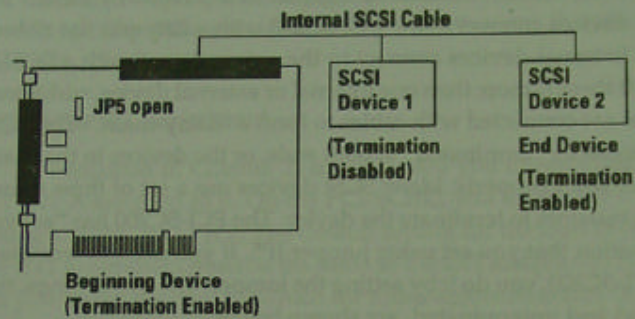

## Example 2: Both internal and external devices connected

